

TM 10-1670-326-23&P

TECHNICAL MANUAL

FIELD MAINTENANCE MANUAL
INCLUDING REPAIR PARTS AND SPECIAL TOOLS LIST
FOR

**T-11 PERSONNEL PARACHUTE SYSTEM
(NSN 1670-01-539-4525)**



DISTRIBUTION STATEMENT A. Approved for public release; distribution is unlimited.

HEADQUARTERS, DEPARTMENT OF THE ARMY

16 March 2009

WARNING SUMMARY

This warning summary contains general safety warnings and hazardous materials warnings that must be understood and applied during operation and maintenance of this equipment. Failure to observe these precautions could result in serious injury or death to personnel. Also included are explanations of safety and hazardous materials icons used within the technical manual.

EXPLANATION OF SAFETY WARNING ICONS



FIRE - flame shows that a material may ignite and cause burns.



PARACHUTIST FALLING - Parachutist falling shows that severe injury or death could result by not adhering to warning.



FLYING PARTICLES - arrows bouncing off face shows that particles flying through the air will harm face.

GENERAL SAFETY WARNINGS DESCRIPTION

WARNING

For First Aid treatment, refer to FM 4-25.11.

WARNING



DEATH could result to personnel if inspections are not performed as specified in this manual. Perform all inspections as specified.

WARNING



Exercise extreme care when using petroleum products to destroy equipment by fire, as these materials are highly flammable. Improper handling may cause injury to personnel.

WARNING



Failure to detect areas of damage may result in malfunction of the parachute and injury or loss of life to personnel.

GENERAL SAFETY WARNINGS DESCRIPTION-CONTINUED

WARNING



The limitations prescribed for parachute canopy patching will be stringently adhered to under all circumstances and without any deviations. Failure to do so may result in death or serious injury to personnel.

WARNING



Deployment bag will be given a complete inspection, including static line and that portion of the static line that is covered by the static line sleeve. Failure to do so could result in serious injury or death to the parachutist.

CHANGE
NO. 1

HEADQUARTERS,
DEPARTMENT OF THE ARMY
WASHINGTON, D.C., 07 APRIL 2010

TECHNICAL MANUAL
FIELD MAINTENANCE MANUAL
INCLUDING REPAIR PARTS AND SPECIAL TOOLS LIST
FOR
T-11 PERSONNEL PARACHUTE SYSTEM
(NSN 1670-01-539-4525)

DISTRIBUTION STATEMENT A. Approved for public release; distribution is unlimited.

TM 10-1670-326-23&P, 16 March 2009, is updated as follows:

1. File this sheet in the front of the manual for reference.
2. This change is the result of adding a slider orientation check when inspecting and packing the main parachute.
3. New or updated change information is indicated by a vertical bar in the outer margin of the page.
4. Remove old pages and insert new pages as indicated below:

Remove Pages

A/B
i-xxii

Insert Pages

A/B
i-xxi/xxii blank

5. Replace the following work packages with their revised version:

Work Package Number

WP 0011
WP 0014

By Order of the Secretary of the Army:

GEORGE W. CASEY, JR.
General, United States Army

CHIEF OF STAFF

Official:

JOYCE E. MORROW

**Administrative Assistant to the
Secretary of the Army**
1008301

Distribution: To be distributed in accordance with initial distribution number (IDN) 256991 requirements for TM 10-1670-326-23&P.

LIST OF EFFECTIVE PAGES/WORK PACKAGES

NOTE: Zero in the "Change No." column indicates an original page or work package.

Date of issue for the original manual is:

Original 16 March 2009
Change 1 07 April 2010

TOTAL NUMBER OF PAGES FOR FRONT AND REAR MATTER IS 46 AND TOTAL NUMBER OF WORK PACKAGES IS 102, CONSISTING OF THE FOLLOWING:

Page / WP No.	Change No.	Page / WP No.	Change No.
Title (2 pgs)	0	WP 0038 (10 pgs)	0
Warning Summary (2 pgs)	0	WP 0039 (4 pgs)	0
i-xxi/xxii blank (22 pgs)	1	WP 0040 (4 pgs)	0
Chp 1 title page (2 pgs)	0	WP 0041 (4 pgs)	0
WP 0001 (6 pgs)	0	WP 0042 (4 pgs)	0
WP 0002 (24 pgs)	0	WP 0043 (4 pgs)	0
WP 0003 (2 pgs)	0	WP 0044 (6 pgs)	0
Chp 2 title page (2 pgs)	0	WP 0045 (2 pgs)	0
WP 0004 (4 pgs)	0	WP 0046 (2 pgs)	0
WP 0005 (10 pgs)	0	WP 0047 (6 pgs)	0
Chp 3 title page (2 pgs)	0	WP 0048 (4 pgs)	0
WP 0006 (2 pgs)	0	WP 0049 (14 pgs)	0
WP 0007 (38 pgs)	0	WP 0050 (2 pgs)	0
WP 0008 (24 pgs)	0	WP 0051 (2 pgs)	0
WP 0009 (4 pgs)	0	WP 0052 (2 pgs)	0
WP 0010 (4 pgs)	0	WP 0053 (2 pgs)	0
WP 0011 (6 pgs)	1	WP 0054 (4 pgs)	0
WP 0012 (6 pgs)	0	WP 0055 (2 pgs)	0
WP 0013 (2 pgs)	0	WP 0056 (2 pgs)	0
WP 0014 (52 pgs)	1	WP 0057 (4 pgs)	0
WP 0015 (50 pgs)	0	WP 0058 (4 pgs)	0
WP 0016 (26 pgs)	0	WP 0059 (8 pgs)	0
WP 0017 (2 pgs)	0	WP 0060 (2 pgs)	0
WP 0018 (2 pgs)	0	WP 0061 (2 pgs)	0
WP 0019 (2 pgs)	0	WP 0062 (2 pgs)	0
WP 0020 (4 pgs)	0	WP 0063 (2 pgs)	0
WP 0021 (2 pgs)	0	WP 0064 (8 pgs)	0
WP 0022 (2 pgs)	0	WP 0065 (2 pgs)	0
WP 0023 (2 pgs)	0	WP 0066 (6 pgs)	0
WP 0024 (2 pgs)	0	WP 0067 (2 pgs)	0
WP 0025 (6 pgs)	0	WP 0068 (2 pgs)	0
WP 0026 (4 pgs)	0	WP 0069 (4 pgs)	0
WP 0027 (6 pgs)	0	WP 0070 (2 pgs)	0
WP 0028 (6 pgs)	0	WP 0071 (2 pgs)	0
WP 0029 (2 pgs)	0	WP 0072 (4 pgs)	0
WP 0030 (6 pgs)	0	WP 0073 (2 pgs)	0
WP 0031 (2 pgs)	0	WP 0074 (6 pgs)	0
WP 0032 (6 pgs)	0	WP 0075 (2 pgs)	0
WP 0033 (2 pgs)	0	WP 0076 (6 pgs)	0
WP 0034 (4 pgs)	0	WP 0077 (2 pgs)	0
WP 0035 (4 pgs)	0	WP 0078 (4 pgs)	0
WP 0036 (4 pgs)	0	WP 0079 (4 pgs)	0
WP 0037 (2 pgs)	0	WP 0080 (6 pgs)	0

Page / WP No.	Change No.
WP 0081 (6 pgs)	0
WP 0082 (4 pgs)	0
WP 0083 (8 pgs)	0
WP 0084 (6 pgs)	0
Chp 4 title page (2 pgs)	0
WP 0085 (6 pgs)	0
WP 0086 (4 pgs)	0
WP 0087 (4 pgs)	0
WP 0088 (4 pgs)	0
WP 0089 (4 pgs)	0
WP 0090 (4 pgs)	0
WP 0091 (4 pgs)	0
WP 0092 (4 pgs)	0
WP 0093 (4 pgs)	0
WP 0094 (4 pgs)	0
WP 0095 (2 pgs)	0
WP 0096 (2 pgs)	0
WP 0097 (2 pgs)	0
Chp 5 title page (2 pgs)	0
WP 0098 (2 pgs)	0
WP 0099 (4 pgs)	0
WP 0100 (12 pgs)	0
WP 0101 (6 pgs)	0
WP 0102 (4 pgs)	0
INDEX-1 thru INDEX-4 (4 pgs)	0
Back Cover (2 pgs)	0

HEADQUARTERS
DEPARTMENT OF THE ARMY
WASHINGTON, D.C., 16 March 2009

TECHNICAL MANUAL
FIELD MAINTENANCE MANUAL
(INCLUDING REPAIR PARTS AND SPECIAL TOOLS LIST)
FOR
T-11 PERSONNEL PARACHUTE SYSTEM
NSN 1670-01-539-4525

REPORTING ERRORS AND RECOMMENDING IMPROVEMENTS

ARMY

You can help improve this manual. If you find any mistakes or if you know of a way to improve the procedures, please let us know. Mail your letter or DA Form 2028 (Recommended Changes to Publications and Blank Forms) directly to: Commander, U.S. Army TACOM Life Cycle Management Command, ATTN: AMSTA-LCL-MPP/TECH PUBS, 1 Rock Island Arsenal, Rock Island, IL 61299-7630. You may also send in your recommended changes via electronic mail or by fax. Our fax number is DSN 793-0726 and commercial number (309) 782-0726. Our e-mail address is TACOMLCMC.DAForm2028@us.army.mil. A reply will be furnished to you.

DISTRIBUTION STATEMENT A: Approved for public release; distribution is unlimited.

TABLE OF CONTENTS

WP Sequence No.
Page No.

Warning Summary

How to Use This Manual

Chapter 1 – General Information, Equipment Description and Theory of Operation

General Information.....	WP 0001
Table 1. Nomenclature Cross-Reference List.....	0001-3
Table 2. List of Acronyms and Abbreviations.....	0001-3
Equipment Description and Data	WP 0002
Figure 1. Main Canopy	0002-2
Figure 2. Slider	0002-3
Figure 3. Drogue Parachute	0002-3
Figure 4. Deployment Sleeve	0002-4
Figure 5. Bridle Assembly.....	0002-4
Figure 6. Main Pack Tray	0002-5
Figure 7. Harness Assembly and Nomenclature.....	0002-7
Figure 8. Main Riser Assembly.....	0002-8
Figure 9. Deployment Bag.....	0002-9
Figure 10. Universal Static Line Modified (with Curved Pin)	0002-9
Figure 11. T-11 Reserve Parachute Assembly	0002-11
Figure 12. Skirt Assist Lines at Low Speed.....	0002-12
Figure 13. Skirt Assist Lines at High Speed.....	0002-12
Figure 14. Ejector Spring Assembly	0002-13
Figure 15. Ripcord Assembly (Handle Side)	0002-13
Figure 16. Ripcord Assembly (Underside)	0002-14
Figure 17. Extractor	0002-14
Figure 18. Reserve Pack Tray.....	0002-15
Figure 19. Reserve Risers.....	0002-15
Figure 20. Protection Cap.....	0002-16
Figure 21. Reserve Closing Loop.....	0002-16
Table 1. T-11 Decals, Data Blocks, and Instruction Plates	0002-20
Theory of Operation	WP 0003

Chapter 2 – Preventive Maintenance Checks and Services

Preventive Maintenance Checks and Services Introduction.....	WP 0004
Preventive Maintenance Checks and Services (PMCS).....	WP 0005
Table 1. Preventive Maintenance Checks and Services for T-11 Personnel Parachute System.....	0005-1

TABLE OF CONTENTS - Continued

	<u>Page No.</u>	<u>WP Sequence No.</u>
Figure 1. Minor Abrasion	0005-2	
Figure 2. Major Abrasion	0005-2	
Figure 3. Minor Abrasion	0005-3	
Figure 4. Major Abrasion	0005-3	
Chapter 3 – Field Maintenance Instructions		
Service Upon Receipt.....		WP 0006
Main Canopy Assembly.....		WP 0007
Table 1. T-11 Personnel Parachute System Major Components.....	0007-2	
Figure 1. Place Connector Links and Riser Assembly	0007-8	
Figure 2. Lay Out Riser Assembly.....	0007-9	
Figure 3. Attaching Risers to Connector Links	0007-9	
Figure 4. Main Canopy Slider and Suspension Line Location	0007-11	
Figure 5. Tightening Connector Link Barrel Nut with Crowfoot Adapter	0007-12	
Figure 6. Tightening Connector Link Barrel Nut and Tacking Each Riser	0007-13	
Figure 7. Securing Lacing and Tying Tape with Surgeon’s Knot Locking Knot	0007-13	
Figure 8. Positioning Riser to Lower Portion of Connector Link	0007-14	
Figure 9. Forming Slip Loop on Log Record Outside	0007-15	
Figure 10. Pass Lacing and Tying Tape Loose Ends Through Corner Attaching Hole	0007-15	
Figure 11. Routing Lacing and Tying Tape Running End Through Log Record Book Centerfold	0007-16	
Figure 12. Log Record Attachment Tie Completed	0007-16	
Figure 13. Pack Tray and Harness Assembly	0007-17	
Figure 14. Securing Horizontal Back Strap	0007-18	
Figure 15. Securing Diagonal Backstraps	0007-19	
Figure 16. Attaching Retainer Bands to Static Line Stow Bars and Static Line Slack Retainer.	0007-20	
Figure 17. Routing Main Closing Loop under Protective Cover, through Grommet, and Tacking Both Sides	0007-21	
Figure 18. Laying Out Risers and Harness Assembly, and Assembling Risers and Harness Assembly.....	0007-23	
Figure 19. Sliding Looped End of Drogue Parachute over Drogue Parachute Attaching Loop	0007-24	
Figure 20. Routing Top of Drogue Parachute through Drogue Parachute Attaching Loop	0007-24	

TABLE OF CONTENTS - Continued

	<u>Page No.</u>	<u>WP Sequence No.</u>
Figure 21. Pulling Drogue Parachute through Drogue Parachute Attaching Loop to Form Girth Hitch.	0007-25	
Figure 22. Attaching Bridle Ring to Quick Release Hook.....	0007-25	
Figure 23. Attaching Bridle Line to Bridle Ring at Top of Canopy....	0007-26	
Figure 24. Routing Opposite End of Bridle Line through Bottom of Sleeve	0007-26	
Figure 25. Connecting Bridle Line Link to Connector Link Loop on Sleeve.....	0007-27	
Figure 26. Attaching Retainer Bands to Deployment Sleeve Bridle Line Stow Panel	0007-27	
Figure 27. Passing the 6-inch Buffer Loop through Deployment Bag Reinforcement Webbing	0007-28	
Figure 28. Passing Loop End of Universal Static Line through Buffer Loop.....	0007-29	
Figure 29. Securing Static Line to Deployment Bag	0007-29	
Figure 30. Positioning Static Line and Snap Hook.....	0007-30	
Figure 31. Passing Loop End of Static Line through Base of Snap Hook	0007-30	
Figure 32. Passing Top of Snap Hook through Loop End of Static Line.....	0007-30	
Figure 33. Sliding Loop Down to Bottom of Snap Hook.....	0007-31	
Figure 34. Passing Loop of Static Line through Buffer Loop on USL Extension	0007-31	
Figure 35. Passing Snap Hook of USL Extension through Loop on Static Line Loop	0007-32	
Figure 36. Making Girth Hitch Securing USL Extension to Static Line	0007-32	
Figure 37. Inside Front Cover.....	0007-33	
Figure 38. Inside Back Cover	0007-34	
Figure 39. Modification Work Order (MWO) Compliance Record Page	0007-34	
Figure 40. Unit Repair and Inspection Data	0007-35	
Figure 41. Note Page	0007-36	
Reserve Canopy Assembly		WP 0008
Figure 1. Assembling the Reserve Pack Tray.....	0008-2	
Figure 2. Assembling the Ejector Spring.....	0008-3	
Figure 3. Attaching Extractor Bridle Lines	0008-4	
Figure 4. Attaching Packing Lanyard to Apex Hook.....	0008-5	
Figure 5. Laying Out Risers.....	0008-6	
Figure 6. Riser Connector Links.....	0008-7	

TABLE OF CONTENTS - Continued

	<u>Page No.</u>	<u>WP Sequence No.</u>
Figure 7. Suspension Line Groups	0008-8	
Figure 8. Attaching Reserve Risers to Reserve Canopy.....	0008-9	
Figure 9. Rotating Risers to Lower Portion of Connector Link	0008-10	
Figure 10. Routing Cord through Top Grommets of Pack Tray	0008-11	
Figure 11. Centering the Spreader Bar between the Upper and Lower Grommets	0008-11	
Figure 12. Routing Type III Cord through Lower Grommet and Over Spreader Bar	0008-12	
Figure 13. Securing the Spreader Bar on Back Side of Pack Tray ..	0008-12	
Figure 14. Aligning Top Bar of Snap Hook with Binding Tape and S-Folding Excess Spreader Bar	0008-13	
Figure 15. Securing Connector Snaps To Pack Tray.....	0008-14	
Figure 16. Securing the Excess Spreader Bar Fold-over.....	0008-15	
Figure 17. Forming Slip Loop on Log Record Outside.....	0008-16	
Figure 18. Passing Lacing Loose Ends through Corner Attaching Hole	0008-16	
Figure 19. Routing Lacing Loose End through Log Record Centerfold	0008-17	
Figure 20. Log Record Attachment Tie Completed.....	0008-17	
Figure 21. Attaching Skirt Assist Lines.....	0008-19	
Figure 22. Inside Front Cover.....	0008-20	
Figure 23. Inside Back Cover	0008-21	
Figure 24. Modification Work Order (MWO) Compliance Record Page	0008-21	
Figure 25. Unit Repair and Inspection Data	0008-22	
Figure 26. Notes Page.....	0008-23	
Main Canopy Service, Shakeout and Airing.....		WP 0009
Figure 1. Connecting Snap on Pulley Rope to Canopy Bridle Loop	0009-1	
Figure 2. Grasping Two Consecutive Suspension Lines and Shaking First Panel	0009-2	
Figure 3. Clearing Suspension Lines of Debris and Removing Entanglements	0009-3	
Figure 4. S-Folding Suspension Lines into Aviator's Kit Bag	0009-4	
Main Canopy Service, Cleaning and Drying		WP 0010
Main Canopy Inspect.....		WP 0011
Reserve Canopy Inspect.....		WP 0012
T-11 Personnel Parachute System Test		WP 0013
Packing Main Parachute		WP 0014

TABLE OF CONTENTS - Continued

	<u>WP Sequence No.</u>
	<u>Page No.</u>
Figure 1. Rigger's View	0014-2
Figure 2. Removing an Inversion.....	0014-3
Figure 3. Passing the Bridle Ring down through Canopy	0014-4
Figure 4. Attach the Riser Assemblies	0014-5
Figure 5. Removing Turns, Tangles, or Twists from Suspension Lines	0014-6
Figure 6. Lifting Lines from other Lines	0014-7
Figure 7. Reaching through Opening with Right Hand.....	0014-7
Figure 8. Pulling Risers through Opening	0014-8
Figure 9. Twisted Suspension Lines	0014-9
Figure 10. Place Sleeve onto Sleeve Organizer	0014-10
Figure 11. Pull Bridle Line through Sleeve	0014-11
Figure 12. Pass Packing Loop Tension Device through Deployment Sleeve	0014-11
Figure 13. Attach Bridle Ring and Packing Loop Tension Device to Quick Release Hook.....	0014-12
Figure 14. Perform Four Line Check	0014-12
Figure 15. 2-Inch Retainer Band on Tension Plate Adapter	0014-13
Figure 16. Pack Tray and Harness Assembly	0014-14
Figure 17. Securing Diagonal Back Straps	0014-15
Figure 18. Laying Out Risers and Harness, and Assembling Risers and Harness.....	0014-17
Figure 19. Flip Right Line Group over Left Line Group and Locate Packing Loop 14	0014-18
Figure 20. Pull Packing Tab from Left Side of Table to Right Side over Seam 14	0014-18
Figure 21. Flaking the Top of the Canopy	0014-19
Figure 22. Canopy Folded and Seam 14 against Table.....	0014-20
Figure 23. Follow Seam 14 to the Lower Lateral Band	0014-20
Figure 24. Grip Suspension Lines and Pull Each Panel of Lower Lateral Band	0014-21
Figure 25. Forming the Flat Fold	0014-21
Figure 26. Perform Slider Orientation (Sheet 1 of 2).....	0014-22
Figure 26. Perform Slider Orientation (Sheet 2 of 2).....	0014-23
Figure 27. Move Slider and Place Neatly in Air Channel	0014-24
Figure 28. Secure Canopy with Packing Weight.....	0014-25
Figure 29. Canopy in Long Fold	0014-26
Figure 30. Pull Deployment Sleeve over Canopy.....	0014-27

TABLE OF CONTENTS - Continued

	<u>Page No.</u>	<u>WP Sequence No.</u>
Figure 31. Release Packing Loop Tension Device	0014-28	
Figure 32. Dressing Bridle Line Stowage Panel and Gathering Center Section Fabric.....	0014-28	
Figure 33. S-Fold Center Section Fabric.....	0014-29	
Figure 34. Stow Folded Bridle in Two Large Retainer Bands on Deployment Sleeve	0014-30	
Figure 35. Roll Bridle Stowage Panel to Edge of S-Folded Center Section	0014-30	
Figure 36. Hold Rolled Bridle Line Stowage Panel and Pull Top of Deployment Sleeve over Canopy.....	0014-31	
Figure 37. Mate Hook and Pile on Sleeve.....	0014-31	
Figure 38. Place Deployment Bag into Deployment Bag Cradle	0014-32	
Figure 39. Secure Deployment Bag into Deployment Cradle	0014-33	
Figure 40. Place Drogue Parachute in Bottom of Deployment Bag	0014-33	
Figure 41. Place Drogue Parachute into Deployment Bag	0014-34	
Figure 42. Place Top of Deployment Sleeve in Deployment Bag ...	0014-34	
Figure 43. Bottom of Sleeve Placed at Bottom and Center of Bag ..	0014-35	
Figure 44. Fold Side Flaps over Deployment Sleeve.....	0014-36	
Figure 45. Secure Top Flap with Stow Hooks.....	0014-36	
Figure 46. Make First Locking Stow	0014-37	
Figure 47. Make Second Locking Stow.....	0014-37	
Figure 48. Flattening the Deployment Bag to Form a Wedge.....	0014-38	
Figure 49. Make First Regular Stow.....	0014-38	
Figure 50. Continue Stowing Suspension Lines.....	0014-39	
Figure 51. Secure Connector Links with Cotton Webbing	0014-40	
Figure 52. Secure Both Sides with a Surgeons Knot Locking Knot ..	0014-40	
Figure 53. Enter Deployment Bag Number in Log Record.....	0014-41	
Figure 54. Rotate Main Pack Tray under Risers	0014-41	
Figure 55. Placing the Deployment Bag on Pack Tray	0014-42	
Figure 56. Close Side Flaps and Secure with a Temporary Pin	0014-43	
Figure 57. Stowing of Modified Universal Static Line Inside Pack Tray.....	0014-44	
Figure 58. Close Bottom Flap and Secure with Temporary Pin.....	0014-45	
Figure 59. Close Top Flap and Secure with Main Curved Pin	0014-46	
Figure 60. Make First Static Line Stow, Close and Secure Pin Protector Flap	0014-47	
Figure 61. Continue Stowing Static Line across the Top of the Pack Tray.....	0014-48	

TABLE OF CONTENTS - Continued

	<u>Page No.</u>	<u>WP Sequence No.</u>
Figure 62. Continue Stowing Static Line across the Top of the Pack Tray (shown with Static Line Extension)	0014-49	
Figure 63. Fill Out Log Record	0014-50	
Figure 64. Connect Chest Strap to 1-inch Quick-fit Friction Adapter	0014-51	
Figure 65. Attach Leg Straps to Leg Strap Quick-Ejector Snaps	0014-51	
Figure 66. Route Waistband under Saddle	0014-52	
Figure 67. Adjust Saddle and Waistband	0014-52	
Reserve Parachute Packing Procedures		WP 0015
Figure 1. Rigger's View	0015-3	
Figure 2. Assembling the Ejector Spring	0015-4	
Figure 3. Prepare Ejector Spring	0015-5	
Figure 4. Passing Apex Hook-up Lanyard through All Apex Loops	0015-6	
Figure 5. Routing the Ticket 8/4 Cotton Thread Through Loop of Apex Hook Lanyard	0015-6	
Figure 6. Placing Connector Links on Tension Plate Adapter	0015-7	
Figure 7. Inspecting the Risers	0015-8	
Figure 8. Routing Cord through Top Grommets of Pack Tray	0015-9	
Figure 9. Centering the Spreader Bar between the Upper and Lower Grommets	0015-9	
Figure 10. Routing Type III Nylon Cord over Spreader Bar	0015-10	
Figure 11. Securing the Spreader Bar on Back Side of Pack Tray	0015-10	
Figure 12. Aligning Top Bar of Snap Hook with Binding Tape and S-Folding Excess Spreader Bar	0015-11	
Figure 13. Securing Connector Straps to Pack Tray	0015-12	
Figure 14. Securing the Excess Spreader Bar Fold-over	0015-13	
Figure 15. Partially S-Folding the Risers into Pack Tray	0015-14	
Figure 16. Performing a Four Line Check	0015-15	
Figure 17. Folding Gores	0015-16	
Figure 18. Organizing the Skirt Assist Lines Entering the Canopy	0015-19	
Figure 19. Folding and Dressing Left and Right Apex Scoops	0015-20	
Figure 20. Tying and Securing Apex Scoop Loop Ends	0015-21	
Figure 21. Securing Remaining Loops	0015-21	
Figure 22. Folding Canopy at Lower Lateral Band	0015-22	
Figure 23. Folding Canopy Evenly into Thirds	0015-22	
Figure 24. S-Folding of the Top Left Side of the Apex Scoop	0015-23	
Figure 25. S-Folding of the Top Right Side of the Apex Scoop	0015-23	

TABLE OF CONTENTS - Continued

	<u>WP Sequence No.</u>
	<u>Page No.</u>
Figure 26. Folding Left and Right Apex Scoops and Complete Long Folding.....	0015-24
Figure 27. Folded Apex Scoops	0015-24
Figure 28. Perform Line Check of the Extractor	0015-25
Figure 29. Folding the Extractor	0015-25
Figure 30. Folding the Extractor Canopy into Thirds.....	0015-26
Figure 31. S-Folding Extractor.....	0015-26
Figure 32. Placing Extractor on Top of Apex Area.....	0015-27
Figure 33. Making Two Remaining Riser Stows	0015-28
Figure 34. Making First Regular Stow	0015-29
Figure 35. Continuing Regular Stows.....	0015-29
Figure 36. Forming Bight and Placing Retainer Band.....	0015-30
Figure 37. Grasping Lines and Removing Slack.....	0015-31
Figure 38. Making a Stow with Suspension Line Bight and Small Retainer Band.....	0015-32
Figure 39. Placing Last Free Stow on top of Stowed Lines	0015-32
Figure 40. Releasing the Apex Hook.....	0015-33
Figure 41. Pulling the Apex Hook Lanyard through the Apex Loops	0015-34
Figure 42. Tying Off Apex Loops.....	0015-34
Figure 43. Placing Canopy into Pack Tray	0015-35
Figure 44. Making First S-Fold	0015-36
Figure 45. Making Second S-Fold.....	0015-36
Figure 46. Making Two Intermediate S-Folds	0015-37
Figure 47. Placing Compressed Ejector Spring on Folded Canopy	0015-37
Figure 48. Forming a Bridge over Top of Ejector Spring.....	0015-38
Figure 49. S-Folding Remaining Canopy	0015-39
Figure 50. S-Folding Extractor Attachment Lines.....	0015-40
Figure 51. Centering Extractor on Top of Folded Canopy	0015-40
Figure 52. Placing Lower Pull up Cord through Lower Grommet	0015-41
Figure 53. Inserting Temporary Pin and Placing Protection Cap.....	0015-42
Figure 54. Exposing Closing Loops and Inserting Temporary Pin	0015-43
Figure 55. Tucking Left and Right Sides into Pack Tray	0015-44
Figure 56. Using T-Bar to Close Pack Tray and Inserting Temporary Pin	0015-44
Figure 57. Inserting Second Temporary Pin.....	0015-45

TABLE OF CONTENTS - Continued

	<u>Page No.</u>	<u>WP Sequence No.</u>
Figure 58. Inserting Right Tuck Tab into Right Tuck Tab Pocket.....	0015-46	
Figure 59. Inserting Lower-Curved Pin through Closing Loop.....	0015-46	
Figure 60. Inserting Top Curved Pin through Closing Loop.....	0015-47	
Figure 61. Inserting Left Tuck Tab into Left Tuck Tab Pocket.....	0015-47	
Figure 62. Removing the Pull-Up Cords.....	0015-49	
Figure 63. Completing Log Record	0015-50	
General Parachute Repair.....		WP 0016
Table 1. Recommended Sewing Machine Code Symbols	0016-3	
Table 2. Stitching and Re-stitching Specifications	0016-3	
Table 3. Bartack Stitching Requirements	0016-5	
Figure 1. Machine Darning	0016-6	
Figure 2. Hand Darning	0016-7	
Figure 3. Box Stitching Pattern with Locking Stitch.....	0016-8	
Figure 4. Straight Cut or Tear Stitching.....	0016-9	
Figure 5. L-Shaped Cut or Tear Stitching.....	0016-9	
Figure 6. Canopy Layout and Patch Construction.....	0016-10	
Figure 7. Sewn Patch	0016-11	
Figure 8. Inverting Damaged Panel and Securing with T-pins.....	0016-12	
Figure 9. Measuring Damaged Area and Cutting Section of New Material	0016-12	
Figure 10. Placing New Material over Damaged Area and Securing with T-pins	0016-13	
Figure 11. Sewing New Material over Damaged Area 1/16-inch from Edge	0016-13	
Figure 12. Re-inverting Damaged Area and Placing onto Sewing Table Patch Side Down	0016-14	
Figure 13. Marking 1-inch in from Stitches and Removing Damaged Area.....	0016-14	
Figure 14. Cutting Patch Corners.....	0016-15	
Figure 15. Sewn Patch	0016-15	
Figure 16. Canopy Repair	0016-17	
Figure 17. Rectangular Patch including Main Seam	0016-18	
Figure 18. Rectangular Patch including a Main Seam and a Cross Seam.....	0016-19	
Figure 19. Rectangular Patch Crossing a Cross Seam and Including Main Seam.....	0016-19	

TABLE OF CONTENTS - Continued

	<u>Page No.</u>	<u>WP Sequence No.</u>
Figure 20. Rectangular Patch Including Lower Lateral Band.....	0016-20	
Figure 21. Rectangular Patch Including Main Seam and Lower Lateral Band	0016-21	
Figure 22. Girth Hitch	0016-22	
Figure 23. Surgeon's Knot Locking Knot.....	0016-22	
Figure 24. Overhand Knot	0016-23	
Figure 25. Square Knot	0016-23	
Figure 26. T-11 Main Canopy.....	0016-24	
Figure 27. T-11 Reserve Canopy	0016-25	
Searing and Waxing Repair		WP 0017
Marking and Restenciling Repair		WP 0018
T-11 Main Parachute Assembly Repair		WP 0019
Table 1. T-11 Main Canopy Repair References.....	0019-1	
Main Canopy Suspension Line Assembly Replace		WP 0020
Figure 1. Replacing a Main Canopy Suspension Line	0020-1	
Figure 2. Routing Suspension Line through Slider.....	0020-2	
Figure 3. Replacing a Main Canopy Suspension Line	0020-3	
Main Canopy Suspension Line Parachute Connector Link Replace		WP 0021
Figure 1. Replacing Main Canopy Suspension Line Connector Link	0021-2	
T-11 Main Bridle Assembly Replace		WP 0022
Figure 1. Place Sleeve onto Sleeve Organizer	0022-1	
Bridle Line Parachute Connector Link Replace		WP 0023
Figure 1. Replacing Connector Links	0023-1	
Figure 2. Connecting Bridle Line Link to Connector Link Loop on Sleeve	0023-2	
T-11 Main Drogue Assembly Replace		WP 0024
Figure 1. Remove Main Drogue Parachute.....	0024-1	
T-11 Main Slider Panel Replace		WP 0025
Figure 1. Removing Connector Links	0025-2	
Figure 2. Tension Plate Adapter Layout.....	0025-2	
Figure 3. Removing Slider from Suspension Lines	0025-3	
Figure 4. Running Suspension Lines through Slider Grommets.....	0025-5	
Slider Panel Metallic Grommets Repair		WP 0026
Figure 1. Repair Grommet.....	0026-2	
Arm Assembly Panels Repair, Replace		WP 0027
Figure 1. Inverting Damaged Panel and Securing with T-pins.....	0027-2	

TABLE OF CONTENTS - Continued

	<u>Page No.</u>	<u>WP Sequence No.</u>
Figure 2. Measuring from Edge of Outside Seam and Cutting New Material	0027-2	
Figure 3. Centering and Pinning New Material to Damaged Panel	0027-3	
Figure 4. Folding Ends Under and Securing with T-pins.....	0027-3	
Figure 5. Sewing New Material to Damaged Panel.....	0027-4	
Figure 6. Removing Damaged Panel	0027-4	
Figure 7. Cutting in Corners at 45 Degree Angle	0027-5	
Figure 8. Folding along Inside Edge and Sewing along Folded Edge	0027-6	
Center Section Assembly Repair, Replace		WP 0028
Figure 1. Inverting Damaged Panel and Securing with T-pins.....	0028-2	
Figure 2. Measuring from Edge of Outside Seam and Cutting New Material	0028-2	
Figure 3. Centering and Pinning New Material to Damaged Panel	0028-3	
Figure 4. Folding Ends Under and Securing with T-pins.....	0028-3	
Figure 5. Sewing New Material to Damaged Section.....	0028-4	
Figure 6. Re inverting Damaged Panel and Placing on Repair Table	0028-4	
Figure 7. Removing Damaged Panel	0028-5	
Figure 8. Cutting in Corners at 45 Degree Angle	0028-5	
Figure 9. Folding along Inside Edge and Sewing along Folded Edge	0028-6	
Figure 10. Stitch over Existing Stitch Patterns	0028-6	
Center Section Assembly Reinforcement Panels Repair.....		WP 0029
Figure 1. Re-stitching Main Canopy Reinforcement Panel	0029-1	
T-11 Large and Small Mesh Panels Repair, Replace.....		WP 0030
Figure 1. Repair Damaged Mesh Panel	0030-2	
Figure 2. Sew Before Tear	0030-2	
Figure 3. Verify Repair is Functional	0030-3	
Figure 4. Centering New Mesh Panel over Opening and Securing with T-pins	0030-4	
Figure 5. Sewing New Mesh Panel in Place	0030-5	
Deployment Sleeve Assembly Repair, Replace.....		WP 0031
Figure 1. Light Duty Sewing Machine Re-stitching	0031-1	
Main Canopy Suspension Line Attaching Loop Repair, Replace		WP 0032
Figure 1. Remove Damaged Suspension Line Attaching Loop	0032-2	
Figure 2. Measure and Cut Type I Webbing	0032-2	

TABLE OF CONTENTS - Continued

	<u>WP Sequence No.</u>
	<u>Page No.</u>
Figure 3. Attach New Suspension Line Loop (Bartack Option Shown)	0032-2
Main Seams Repair	WP 0033
Figure 1. Measure the Damaged Area	0033-1
Figure 2. Place New Material Centered over the Damaged Area	0033-2
Figure 3. Sew the New Material over the Damaged Area	0033-2
Lower Lateral Band Repair	WP 0034
Figure 1. Smooth Out Damaged Area on a Repair Table	0034-2
Figure 2. Measure Damaged Area and Cut New Material	0034-2
Figure 3. Place New Material Centered Over Damaged Area	0034-3
Figure 4. Sew the New Material Over the Damaged Area	0034-3
Bridle Attachment Assembly Repair, Replace	WP 0035
Figure 1. Removing the Damaged Apex Bridle Assembly	0035-2
Figure 2. Cutting Two Lengths of Webbing with Heated Blade Cutter	0035-2
Figure 3. Fabricating a New Bridle Attachment Assembly	0035-3
Figure 4. Attaching the New Bridle Attachment Assembly to the Canopy	0035-4
T-11 Main Riser Set Repair, Replace	WP 0036
Figure 1. Place Connector Links on Tension Plate Adapter	0036-2
Figure 2. Lay Out Riser Assembly	0036-3
Log Record Book Pocket Repair, Replace	WP 0037
T-11 Main Pack Tray Repair, Replace	WP 0038
Figure 1. Remove Harness Assembly from Pack Tray	0038-2
Figure 2. Removing Unserviceable Pack Tray	0038-3
Figure 3. Routing Main Closing Loop	0038-4
Figure 4. Tacking Both Sides of the Protective Cover	0038-5
Figure 5. Pack Tray and Harness Assembly	0038-6
Figure 6. Securing Horizontal Back Strap	0038-7
Figure 7. Route Tuck Tabs, Close Snap Fastener, and Snap Fastener Secured	0038-8
Figure 8. Attaching Retainer Bands to Static Line Stow Bars and Static Line Slack Retainer	0038-9
Main Pack Tray Large Fabric Loop Replace	WP 0039
Figure 1. Routing Main Closing Loop	0039-2
Figure 2. Tacking Both Sides of the Protective Cover	0039-3
Main Pack Tray Closing Pin Cover Replace	WP 0040
Figure 1. Remove Damaged Pin Protector Cover	0040-1

TABLE OF CONTENTS - Continued

	<u>Page No.</u>	<u>WP Sequence No.</u>
Figure 2. Insert Barrel of Replacement Grommet through Accommodating Hole	0040-2	
Figure 3. Position Grommet on the Die	0040-2	
Figure 4. Spread Grommet Barrel	0040-3	
Figure 5. Replace Damaged Pin Protector Flap.....	0040-3	
Figure 6. Sew Pin Protector Cover to Binding Tape	0040-4	
Main Pack Tray Stiffener Metallic Grommets Repair, Replace.....		WP 0041
Figure 1. Insert Barrel of Replacement Grommet through Accommodating Hole	0041-1	
Figure 2. Position Grommet on the Die	0041-2	
Figure 3. Spread Grommet Barrel	0041-2	
Main Pack Tray Snap Fastener Repair, Replace.....		WP 0042
Figure 1. Hand-held Method.....	0042-3	
Figure 2. Hand or Foot Operated Press Method	0042-3	
Main Side Stiffeners Repair, Replace		WP 0043
Figure 1. Remove Original Grommet	0043-2	
Figure 2. Remove Stitching Bordering the Stiffener	0043-2	
Figure 3. Insert a New Stiffener.....	0043-3	
Figure 4. Insert Barrel of Replacement Grommet	0043-3	
Figure 5. Position Grommet on Die with Barrel Facing Up and Place Washer over Grommet Barrel	0043-4	
Figure 6. Spread Grommet Barrel	0043-4	
Main Pack Tray Top/Bottom Stiffeners Repair, Replace		WP 0044
Figure 1. Remove Original Grommet	0044-2	
Figure 2. Remove Stiffener.....	0044-2	
Figure 3. Insert a New Stiffener.....	0044-3	
Figure 4. Insert Barrel of Replacement Grommet through Accommodating Hole in Material.	0044-3	
Figure 5. Position Grommet on Die with Barrel Facing Up and Place Washer over Grommet Barrel	0044-4	
Figure 6. Spread Grommet Barrel	0044-4	
Diagonal Back Strap Retainer Replace.....		WP 0045
Figure 1. Replacing Diagonal Back Strap Retainer.....	0045-1	
Harness Back Strap Retainer Repair, Replace.....		WP 0046
T-11 Harness Assembly Replace.....		WP 0047
Figure 1. Remove Harness Assembly from Pack Tray	0047-1	
Figure 2. Removing Unserviceable Pack Tray	0047-2	
Figure 3. Main Pack Tray	0047-3	

TABLE OF CONTENTS - Continued

	<u>Page No.</u>	<u>WP Sequence No.</u>
Figure 4. Pack Tray and Harness Assembly	0047-3	
Figure 5. Securing Horizontal Back Strap	0047-4	
Figure 6. Route Diagonal Back Strap Keeper	0047-5	
Figure 7. Enter the Date in Service on Horizontal Back Strap in Data Label	0047-6	
T-11 Hip Pad Assembly Repair, Replace.....		WP 0048
Figure 1. Replacing the L-Shaped Ejector Snap Pad	0048-2	
Figure 2. Tacking New L-Shaped Ejector Snap Pad.....	0048-3	
T-11 Saddle Assembly/Right and Left Upper Harness/T-11 Diagonal Assembly/Tuck Tab Assembly Repair, Replace		WP 0049
Figure 1. Proper Layout of Harness Assembly.....	0049-2	
Figure 2. Remove Stitching From Diagonal Back Straps.....	0049-3	
Figure 3. Replacing Harness Left Upper Main Lift Web Assemblies ..	0049-4	
Figure 4. Right and Left Upper Main Lift Web Assemblies	0049-5	
Figure 5. Saddle Assembly.....	0049-6	
Figure 6. Layout of Harness Assembly Components	0049-7	
Figure 7. Routing of the Left Upper Main Lift Web Straps	0049-8	
Figure 8. Route Horizontal Back Straps through Back Strap Adjuster	0049-9	
Figure 9. Tuck Tab Assembly.....	0049-9	
Figure 10. Apply Glue to the Upper Main Lift Web.....	0049-10	
Figure 11. Proper Positioning of the Tuck Tab Assembly	0049-10	
Figure 12. Attach Tuck Tab Assembly to the Upper Main Lift Web Assemblies	0049-11	
Figure 13. Tuck Tab Retainer Sewn.....	0049-12	
Figure 14. Upper Main Lift Web Assemblies Placed on Small Size Setting.....	0049-13	
Figure 15. Secure Tuck Tab Assembly	0049-13	
Figure 16. Roll and Sew Free End Diagonal Back Strap	0049-14	
T-11 Shoulder Pad Assembly Repair, Replace.....		WP 0050
Figure 1. Harness Shoulder Pad	0050-2	
Excess Webbing Keeper Assembly Replace		WP 0051
Figure 1. 4 ½-inch Length of Type I Elastic Webbing	0051-1	
Figure 2. First Seam of Elastic Webbing	0051-1	
Figure 3. Loop Stitching Locations	0051-2	
Figure 4. Completed Harness Webbing Retainer.....	0051-2	
T-11 Reserve Canopy Assembly Repair.....		WP 0052
T-11 Reserve Canopy Repair References	0052-1	

TABLE OF CONTENTS - Continued

	<u>WP Sequence No.</u>
	<u>Page No.</u>
T-11 Reserve Canopy Suspension Line Assembly Replace	WP 0053
Figure 1. Attaching New Suspension Line To Attaching Loop	0053-1
Figure 2. Attaching New Suspension Line To Connector Link	0053-2
T-11 Reserve Extractor Assembly Replace	WP 0054
Figure 1. Remove Cord from Apex Extractor Attaching Loop	0054-1
Figure 2. Attach Reserve Extractor Parachute	0054-3
T-11 Reserve Ejector Spring Assembly Test, Replace	WP 0055
Figure 1. Spring Compression Test Tube	0055-2
Reserve Canopy Gore Panels Repair	WP 0056
T-11 Reserve Vent Panel Repair, Replace	WP 0057
Figure 1. Repair Damaged Vent Panel	0057-1
Figure 2. Sew Before Tear	0057-2
Figure 3. Verify Repair Is Functional	0057-2
Figure 4. Replace Damaged Mesh Panel	0057-3
Reserve Canopy Skirt Assist Ties Replace	WP 0058
Figure 1. Install Skirt Assist Ties	0058-2
Reserve Suspension Line Parachute Connector Link Replace	WP 0059
Figure 1. Passing Apex Hook Lanyard through all Apex Loops	0059-1
Figure 2. Routing the Ticket 8/4 Cotton Thread through Loop of Apex Hook Lanyard	0059-2
Figure 3. Placing Connector Links on Tension Plate Adapter	0059-2
Figure 4. Remove Tacking	0059-3
Figure 5. Replace Connector Links	0059-3
Figure 6. Rotate Connector Link to Riser	0059-4
Figure 7. Riser Connector Links	0059-5
Figure 8. Suspension Line Groups	0059-6
Figure 9. Tighten Barrel Nut on Connector Link	0059-7
Figure 10. Tack Riser with Lacing and Tying Tape	0059-7
Figure 11. Rotating Risers to Lower Portion of Connector Link	0059-8
T-11 Reserve Protection Cap Assembly Replace	WP 0060
Reserve Canopy Scoop Repair	WP 0061
Reserve Canopy Apex Vent Bridle Loop Repair, Replace	WP 0062
Figure 1. Folding a New Loop	0062-2
Reserve Canopy Suspension Line Attaching Loop Repair	WP 0063
T-11 Reserve Riser Set Repair, Replace	WP 0064
Figure 1. Passing Apex Hook Lanyard through all Apex Loops	0064-2

TABLE OF CONTENTS - Continued

	<u>WP Sequence No.</u>
	<u>Page No.</u>
Figure 2. Routing the Ticket 8/4 Cotton Thread through Loop of Apex Hook Lanyard.....	0064-3
Figure 3. Placing Connector Links on Tension Plate Adapter.....	0064-3
Figure 4. Remove Tacking	0064-4
Figure 5. Riser Connector Links.....	0064-5
Figure 6. Suspension Line Groups.....	0064-6
Figure 7. Tighten Barrel Nut on Connector Link.....	0064-7
Figure 8. Tack Riser with Lacing and Tying Tape.....	0064-7
Figure 9. Rotating Risers to Lower Portion of Connector Link.....	0064-8
Reserve Riser Hook and Loop Fastener Tape/Reserve Pack Tray Hook Fastener Repair, Replace.....	WP 0065
Table 1. Hook and Pile Fastener Material.....	0065-2
T-11 Reserve Pack Tray Assembly Repair, Replace.....	WP 0066
Figure 1. Remove Reserve Pack Tray from Reserve Canopy Risers	0066-2
Figure 2. Aligning Top Bar of Snap Hook with Binding Tape and S-Folding Excess Spreader Bar.....	0066-3
Figure 3. Securing Connector Snaps To Pack Tray.....	0066-4
Figure 4. Securing the Excess Spreader Bar Fold-over.....	0066-5
Reserve Pack Tray Edge Binding Repair.....	WP 0067
Reserve Pack Tray Grommets Repair, Replace.....	WP 0068
Figure 1. Reserve Pack Tray Grommet Size #0.....	0068-2
Reserve Pack Tray Elastic Riser Stow Bars Repair, Replace	WP 0069
Figure 1. Remove Damaged Elastic Riser Stow Bar	0069-2
Figure 2. Replace Lower Elastic Riser Stow Bar.....	0069-3
Reserve Pack Tray Waistband Retainer Repair, Replace	WP 0070
Figure 1. Reserve Pack Tray Waistband Retainers	0070-2
T-11 Reserve Top and Bottom Stiffener Replace	WP 0071
Figure 1. Remove Stitching Bordering the Stiffener	0071-1
Figure 2. Insert a New Stiffener.....	0071-2
T-11 Reserve Ripcord Assembly Replace, Test	WP 0072
Main Deployment Bag Repair	WP 0073
T-11 Main Bag Stow Bar Assembly Repair, Replace	WP 0074
Figure 1. Mark Damaged Stow Loop.....	0074-1
Figure 2. Measure and Mark Opposite Side of Stow Loop	0074-2
Figure 3. Cut Damaged Stow Loop	0074-2
Figure 4. Prepare Stow Loop Panel for Sewing.....	0074-3

TABLE OF CONTENTS - Continued

	<u>Page No.</u>	<u>WP Sequence No.</u>
Figure 5. Sew Stow Loop	0074-3	
Figure 6. Mark Damaged Suspension Line Stow Loop Panel on Deployment Bag.....	0074-4	
Figure 7. Remove Stitching from Inside Deployment Bag	0074-4	
Figure 8. Remove Damaged Suspension Line Stow Loop Panel	0074-5	
Figure 9. Position the New Suspension Line Stow Loop Panel in Place.....	0074-5	
Figure 10. Sew Outer Edge of Suspension Line Stow Loop Panel.....	0074-6	
Figure 11. Sew Second Row of Stitching Around Suspension Line Stow Loop Panel.....	0074-6	
Main Deployment Bag Locking Stow Loop Repair		WP 0075
Main Deployment Bag Tie Down Loop Repair, Replace.....		WP 0076
Figure 1. Remove Damaged Loop and Stitching	0076-2	
Figure 2. Cut New Tie-Down Loop Webbing.....	0076-2	
Figure 3. Mark and Fold Webbing	0076-3	
Figure 4. Stitch Along the Mark Using Three Complete Passes	0076-3	
Figure 5. Fold Material at Stitching Forming a Loop	0076-4	
Figure 6. Fold Along Running End Over Short Running End.....	0076-4	
Figure 7. Position the New Loop	0076-4	
Figure 8. Stitch the New Loop	0076-5	
Main Deployment Bag Side Flaps Repair		WP 0077
Packing Loop Repair, Replace.....		WP 0078
Figure 1. Marking Position of Original Packing Loop	0078-2	
Figure 2. Removing Damaged Packing Loop with Stitch Removal Tool	0078-2	
Figure 3. Cutting an 8-inch Length of Type I Nylon Webbing	0078-3	
Figure 4. Sewing New Packing Loop to Canopy	0078-3	
Packing Tab Repair, Replace.....		WP 0079
Figure 1. Marking Position of Original Packing Tab	0079-2	
Figure 2. Removing Damaged Packing Tab with Stitch Removal Tool	0079-2	
Figure 3. Cutting a 15½-inch Length of Type I Nylon Webbing	0079-3	
Figure 4. Sewing New Packing Tab to Canopy.....	0079-3	
Modified Personnel Static Line Replace		WP 0080
Figure 1. Remove Unserviceable Portion of Static Line.....	0080-1	
Figure 2. Position Deployment Bag with Stow Loops Facing Up.....	0080-2	
Figure 3. Static Line through the 6-Inch Buffer Loop	0080-2	
Figure 4. Secure Static Line to Deployment Bag	0080-3	

TABLE OF CONTENTS - Continued

	<u>Page No.</u>	<u>WP Sequence No.</u>
Figure 5. Position the Snap Hook.....	0080-3	
Figure 6. Pass the 3½-Inch Loop End of Static Line through Opening of Snap Hook.....	0080-3	
Figure 7. Pass Top of Snap Hook through Static Line Loop	0080-4	
Figure 8. Form a Taut Girth Hitch.....	0080-4	
Figure 9. Pass the 3½-Inch Loop on the Static Line through the 2-Inch Buffer Loop.....	0080-5	
Figure 10. Pass Snap Hook of USL 5-Foot Extension through Loop on Static Line.....	0080-5	
Figure 11. Girth Hitch Securing the 5-Foot Extension to Static Line	0080-6	
Personnel Parachute Static Line Extension Replace.....		WP 0081
Figure 1. Remove 5-Foot Extension from Static Line	0081-1	
Figure 2. Slide Loop from Bottom of Snap Hook and Remove from Indent.	0081-1	
Figure 3. Pass Static Line Loop over Top of Snap Hook	0081-2	
Figure 4. Pass Loop End of Static Line Extension through Opening in Base of Snap Hook.....	0081-2	
Figure 5. Attaching Snap Hook to Static Line and USL 5-Foot Extension.....	0081-3	
Figure 6. Pass 3½-Inch Loop End of Static Line through Opening in Base of Snap Hook.....	0081-3	
Figure 7. Pass Top of Snap Hook through the Static Line Loop	0081-4	
Figure 8. Snap Hook through the Static Line Loop Secured with Girth-Hitch.....	0081-4	
Figure 9. Attach the USL 5-Foot Extension to Static Line.....	0081-5	
Figure 10. Pass Snap Hook of USL 5-Foot Extension through the 3½-Inch Loop on the Static Line.....	0081-5	
Figure 11. Secure 5-Foot Extension to Static Line with Taut Girth-Hitch.....	0081-6	
Static Line Snap Hook Replace		WP 0082
Figure 1. Slide Loop from Bottom of Snap Hook and Remove from Indent.	0082-1	
Figure 2. Pass Loop over Top of Snap Hook	0082-2	
Figure 3. Pass Loop End of Static Line or Static Line Extension through Opening In Base of Snap Hook	0082-2	
Figure 4. Attaching Snap Hook to Static Line and USL 5 Foot Extension.....	0082-3	
Figure 5. Pass 3½-Inch Loop End of Static Line Through Opening in the Base of Snap Hook.....	0082-3	

TABLE OF CONTENTS - Continued

	<u>Page No.</u>	<u>WP Sequence No.</u>
Figure 6. Pass Top of Snap Hook through the Static Line Loop	0082-3	
Figure 7. Snap Hook through Static Line Loop Secured with Girth-Hitch	0082-4	
Preparation for Storage or Shipment		WP 0083
Figure 1. Folding of Gore Groups Completed.	0083-3	
Figure 2. Suspension Lines Stowed on Pack.	0083-4	
Figure 3. Accordion Folding the Canopy.	0083-4	
Figure 4. Folded Canopy Secured.	0083-5	
Figure 5. Rigger Rolling.	0083-6	
Figure 6. Roll the Canopy tightly toward the Canopy Skirt.	0083-7	
Figure 7. Continue Rolling Canopy toward Lower End of Suspension Lines and Risers.	0083-7	
Figure 8. Secure Rolled Canopy Assembly within Pack Tray.	0083-8	
Illustrated List of Manufactured Items		WP 0084
Table 1. Illustrated List of Manufactured Items Index	0084-1	
Figure 1. Viewing Slot.	0084-3	
Figure 2. Fabricating 32-Pound Weight.	0084-4	
Figure 3. Fabricating 32-Pound Weight-Continued.	0084-5	
Figure 4. Fabricating 32-Pound Weight-Continued.	0084-5	
Figure 5. Reserve Ripcord Pull Handle Cuff.	0084-6	
Figure 6. Packing Frame Support Loop	0084-6	
Chapter 4 - Parts Information		
Repair Parts and Special Tools List (RPSTL), Introduction		WP 0085
Table 1. SMR Code	0085-1	
Group 00 T-11 Personnel Parachute System		WP 0086
Figure 1. T-11 Personnel Parachute System (Sheet 1 of 2)	0086-1	
Figure 1. T-11 Personnel Parachute System (Sheet 2 of 2)	0086-2	
Group 01 Main Canopy		WP 0087
Figure 2. Main Canopy	0087-2	
Group 02 Main Risers		WP 0088
Figure 3. Main Risers	0088-2	
Group 03 Main Pack Tray		WP 0089
Figure 4. Main Pack Tray	0089-2	
Group 04 T-11 Harness Assembly		WP 0090
Figure 5. T-11 Harness Assembly	0090-2	
Group 05 T-11R Canopy Assembly		WP 0091

TABLE OF CONTENTS - Continued

	<u>Page No.</u>	<u>WP Sequence No.</u>
Figure 6. T-11R Canopy Assembly	0091-2	
Group 06 T-11 Reserve Riser Set.....		WP 0092
Figure 7. T-11 Reserve Riser Set.....	0092-2	
Group 07 T-11R Pack Tray Assembly		WP 0093
Figure 8. T-11R Pack Tray Assembly	0093-2	
Group 08 Main Deployment Bag		WP 0094
Figure 9. Main Deployment Bag	0094-2	
Group 99 Bulk Material.....		WP 0095
National Stock Number Index.....		WP 0096
Part Number Index		WP 0097
Chapter 5 - Supporting Information		
References		WP 0098
Introduction for Maintenance Allocation Chart (MAC).....		WP 0099
Maintenance Allocation Chart (MAC).....		WP 0100
Table 1. MAC for T-11 Personnel Parachute System	0100-1	
Table 2. Tools and Test Equipment for T-11 Personnel Parachute System.....	0100-8	
Table 3. Remarks for T-11 Personnel Parachute System.....	0100-11	
Expendable and Durable Items List		WP 0101
Table 1. Expendable and Durable Items List	0101-1	
Tool Identification List.....		WP 0102
Table 1. Tool Identification List for T-11 Personnel Parachute System.....	0102-1	
Alphabetical Index		

HOW TO USE THIS MANUAL

HOW TO OBTAIN TECHNICAL MANUALS

When a new system is introduced to the Army inventory, it is the responsibility of the receiving units to notify and inform the Unit Publications Clerk that a Technical Manual is available for the new system. Throughout the life cycle of the new system, the Publications Proponent will also provide updates and changes to the Technical Manual.

To receive new Technical Manuals or change packages to fielded Technical Manuals, provide the Unit Publications Clerk the full Technical Manual number, title, date of publication, and number of copies required. The Unit Publications Clerk will then justify the request through the Unit Publications Officer. When the request is approved, DA Form 12-R is used to order the Technical Manual from the Army Publishing Directorate (APD). Obtain the form and request a publications account from the APD Web site at <http://www.apd.army.mil>. Once on the Website, click on the "Orders/Subscriptions/Reports" tab. From the dropdown menu, select "Establish an Account," then select "Tutorial" and follow the instructions in the tutorial presentation.

Complete information for obtaining Army publications can be found in DA PAM 25-33.

In this manual, primary chapters appear in upper case/capital letters; work packages are presented in numeric sequence, e.g., 0001 00; paragraphs within a work package are not numbered and are presented in a titles format. For a first level paragraph, title all upper case/capital letters, e.g., FRONT MATTER subordinate paragraph title will have the first letter of the first word of each principle word all upper case/capital letters, e.g., Manual Organization and Page Numbering System. The location of additional material that must be referenced is clearly marked. Illustrations supporting maintenance procedures/text are located underneath, or as close as possible to, their referenced paragraph.

FRONT MATTER. Front matter consists of front cover, warning summary, title block, table of contents, and how to use this manual page.

CHAPTER 1 - INTRODUCTION. Chapter 1 contains general information, equipment description and data, as well as theory of operation.

CHAPTER 2 – FIELD MAINTENANCE INSTRUCTIONS. Chapter 2 contains field maintenance procedures that include service upon receipt, assembling the main and reserve canopies, preventive maintenance checks and services information, and maintenance procedures authorized at the unit level.

CHAPTER 3 - DIRECT SUPPORT MAINTENANCE INSTRUCTIONS. Chapter 3 provides maintenance procedures authorized at the direct support level.

CHAPTER 4 - SUPPORTING INFORMATION. Chapter 4 contains references, maintenance allocation chart, repair parts and special tools list (RSPSTL), national stock number index, part number index, expendable and durable items list, and illustrated list of manufactured items.

REAR MATTER. Rear matter consists of alphabetical index, DA Form 2028, authentication page, and back cover.

Manual Organization and Page Numbering System. The manual is divided into five major chapters that detail the topics mentioned above. Within each chapter are work packages covering a wide range of topics. Each work package is numbered sequentially starting at page 1. The work package has its own page-numbering scheme and is independent of the page numbering used by other work packages. Each page of a work package has a page number of XXXX-YY where XXXX is the work package number (e.g. 0010 is work package 10), and YY represents the number of the page within that work package. If work packages were expanded during a change cycle, point numbers are added to the basic WP sequence numbers in consecutive order (i.e., WP 0034.1, WP 0034.2, WP 0034.3). A page number such as 0010-1/2 blank means that page 1 contains information but page 2 of that work package has been intentionally left blank.

Finding Information. The table of contents permits the reader to find information in the manual quickly. The reader should start here first when looking for a specific topic. The table of contents lists the topics contained within each chapter and the work package sequence number where it can be found.

Example: If the reader were looking for instructions on Assembling the Reserve Canopy, which is a unit maintenance topic, the table of contents indicates that unit maintenance information can be found in chapter 2. Scanning down the listings for chapter 2, information on Assembling the Reserve Canopy can be found in WP 0008 (i.e. Work Package 8).

An Alphabetical Index can be found at the back of the manual; specific topics are listed with the corresponding work package number.

CHAPTER 1

**GENERAL INFORMATION, EQUIPMENT DESCRIPTION,
AND THEORY OF OPERATION
FOR
T-11 PERSONNEL PARACHUTE SYSTEM**

FIELD MAINTENANCE**GENERAL INFORMATION**

SCOPE**Type of Manual**

This technical manual provides field maintenance instructions for the T-11 Personnel Parachute System. This manual also provides a Repair Parts and Special Tools List (RPSTL), located in WP 0085 through WP 0097.

Part Number and Equipment Name

Part Number 11-1-7050-1, T-11 Personnel Parachute System.

Purpose of Equipment

The T-11 Personnel Parachute System provides capability to safely deliver an airborne soldier and individual equipment from an aircraft in flight for the vertical assault on an enemy.

MAINTENANCE FORMS, RECORDS, AND REPORTS

Department of the Army forms and procedures used for equipment maintenance will be those prescribed by (as applicable) DA PAM 738-750, Functional Users Manual for the Army Maintenance Management System (TAMMS); DA PAM 738-751, Functional Users Manual for the Army Maintenance Management Systems - Aviation (TAMMS-A); or AR 700-138, Army Logistics Readiness and Sustainability. Additional maintenance forms, records, and reports that are to be used by organizational and field maintenance personnel are listed in and prescribed by TM 10-1670-201-23 and TB 43-0002-43.

REPORTING EQUIPMENT IMPROVEMENT RECOMMENDATIONS (EIR)

If your T-11 Personnel Parachute System needs improvement, let us know. Send us an EIR. You, the user, are the only one who can tell us what you don't like about your equipment. Let us know why you don't like the design or performance.

If you have Internet access, the easiest and fastest way to report problems or suggestions is to go to <https://aeps.ria.army.mil/aepspublic.cfm> (scroll down and choose the "Submit Quality Deficiency Report" bar). The Internet form lets you choose to submit an Equipment Improvement Recommendation (EIR), a Product Quality Deficiency Report (PQDR) or a Warranty Claim Action (WCA).

You may also submit your information using an SF 368 (Product Quality Deficiency Report). You can send your SF 368 via e-mail, regular mail, or facsimile using the addresses/facsimile numbers specified in DA PAM 750-8, The Army Maintenance Management System (TAMMS) Users Manual. We will send you a reply.

CORROSION PREVENTION AND CONTROL (CPC)

Corrosion Prevention and Control (CPC) of Army materiel is a continuing concern. It is important that any corrosion problems with this item be reported so that the problem can be corrected and improvements can be made to prevent the problem in future items.

Corrosion specifically occurs with metals. It is an electrochemical process that causes the degradation of metals. It is commonly caused by exposure to moisture, acids, bases, or salts. An example is the rusting of iron. Corrosion damage in metals can be seen, depending on the metal, as tarnishing, pitting, fogging, surface residue, and/or cracking.

CORROSION PREVENTION AND CONTROL (CPC) - CONTINUED

Plastics, composites, and rubbers can also degrade. Degradation is caused by thermal (heat), oxidation (oxygen), solvation (solvents), or photolytic (light, typically UV) processes. The most common exposures are excessive heat or light. Damage from these processes will appear as cracking, softening, swelling, and/or breaking.

SF Form 368, Product Quality Deficiency Report should be submitted to the address specified in DA PAM 750-8, Functional Users Manual for the Army Maintenance Management System (TAMMS).

DESTRUCTION OF ARMY MATERIEL TO PREVENT ENEMY USE

General Information

Objective. Methods of destruction used to inflict damage on air delivery equipment should make it impossible to restore equipment to a usable-condition in a combat zone, by either repair or cannibalization.

Authority. Destruction of air delivery equipment that is in imminent danger of capture by an enemy is a command decision that must be made by a battalion or higher commander, or the equivalent.

Implementation plan. All units that possess air delivery equipment should have a plan for the implementation of destruction procedures.

Training. All personnel who use or perform such functions as rigging, packing, maintenance, or storage of air delivery equipment, should receive thorough training on air delivery equipment destruction procedures and methods. The destruction methods demonstrated during training should be simulated. Upon completion of training, all applicable personnel should be thoroughly familiar with air delivery equipment destruction methods and be capable of performing destruction without immediate reference to any publication.

Specific Methods

Specific methods of destroying Army materiel to prevent enemy use shall be by mechanical means, fire, or by use of natural surroundings.

Destruction by Mechanical Means. Air delivery equipment metal assemblies, parts, and packing aids shall be destroyed using hammers, bolt cutters, files, hacksaws, drills, screwdrivers, crowbars, or other similar devices used to smash, break, bend, or cut.

WARNING



Exercise extreme care when using petroleum products to destroy equipment by fire, as these materials are highly flammable. Improper handling may cause injury to personnel.

Destruction by Fire. Items that can be destroyed by fire shall be burned. The destruction of equipment by use of fire is an effective method of destroying low-melting-point metal items (e.g., side rails, threaded portions of nuts and bolts, and platforms). However, mechanical destruction should be completed first, whenever possible, before initiating destruction by fire. When items to be destroyed are made of metal, textile materials (or some comparable low combustible material) they should be packed under and around the items, then soaked with a flammable petroleum product and ignited. Proper concentration of equipment that is suitable for burning will provide a hotter and more destructive fire.

DESTRUCTION OF ARMY MATERIEL TO PREVENT ENEMY USE - CONTINUED

Destruction by Use of Natural Surroundings. Small vital parts of assemblies that are easily accessible may be disposed of as follows: Disposal or denial of equipment to an enemy may be accomplished through use of natural surroundings. Accessible vital parts of assemblies may be removed and scattered through dense foliage, buried in dirt or sand, or thrown into a lake, stream, or other body of water. Total submersion of equipment in a body of water will provide water damage as well as concealment. Salt water will inflict extensive damage to air delivery equipment.

PREPARATION FOR STORAGE AND SHIPMENT

For storage and shipment, refer to WP 0083 of this manual.

NOMENCLATURE CROSS-REFERENCE LIST

Table 1. Nomenclature Cross-Reference List.

Common Name	Official Nomenclature
Aviator's Kit Bag	Flier's Kit Bag
Bridle Line	T-11 Main Bridle Assembly
Center Assembly	Center Section Assembly
Crocus Cloth	Abrasive Cloth
Deployment Bag Locking Stow Panel	Closing Flap
Deployment Bag Securing Loop	Suspension Loop
Drogue Parachute	T-11 Main Drogue Assembly
Equipment D-Ring	Equipment Ring
Finger Trap Tool	Line Insertion Tool
Horizontal Back Strap	T-11 Diagonal Assembly
L-Shaped Ejector Snap Pads	T-11 Hip Pad Assembly
Main Canopy	T-11 Main Parachute Assembly
Main Closing Loop	Large Fabric Loop
Main Lift Web	Left and Right Upper Harness
Main Riser Assembly	T-11 Main Riser Set
Static Line Slack Retainer Loop	Static Line Slack Retainer
Static Line Sleeve	Static Line Protective Sleeve
Stow Loop	Suspension Line Stow Loop
Universal Static Line Modified (With Curved Pin)	Modified Personnel Static Line
USL 5-Foot Extension	Personnel Parachute Static Line Extension
USL Snap Hook	Static Line Snap Hook

LIST OF ACRONYMS AND ABBREVIATIONS

Table 2. List of Acronyms and Abbreviations.

Acronym/Abbreviation	Meaning
AGL	Above Ground Level
BER	Beyond Economical Repair
BOI	Basis of Issue
CAGEC	Commercial and Government Entity Code
cfm	Cubic Feet Per Minute
cm	Centimeter
CPC	Corrosion Prevention and Control
CRA	Canopy Release Assembly
DA	Department of the Army
Dtd	Dated
EA	Each
EIR	Equipment Improvement Recommendation
EDS	Electrostatic Discharge Sensitive

LIST OF ACRONYMS AND ABBREVIATIONS - CONTINUED

Table 2. List of Acronyms and Abbreviations - Continued

Acronym/Abbreviation	Meaning
°F	Degree Fahrenheit
FG	Foliage Green
FSC	Federal Supply Classification
ft	Foot
FPS	Foot Per Second
GPM	Ground Precautionary Message
IAW	In Accordance With
ID	Identification
in	Inch
IP	Pack In-Process Inspector
KIAS	Knots Indicated Air Speed
L	Liter
LG	Long
Lb	Pound
MAC	Maintenance Allocation Chart
MAM	Maintenance Advisory Message
MOLLE	Modular Lightweight Load-Carrying Equipment
MOS	Military Occupational Specialty
MTOE	Modified Table of Organization and Equipment
MWO	Modification Work Order
NCOIC	Non-Commissioned Officer In Charge
NIIN	National Item Identification Number
NLT	No Later Than
no	Number
NSN	National Stock Number
oz	Ounce
PIS	Placed In Service
PMCS	Preventive Maintenance Checks and Services
PQDR	Product Quality Deficiency Report
PSI	Pounds per Square Inch
PVC	Polyvinyl Chloride
RPSTL	Repair Parts and Special Tools List
SF	Standard Form
SMR	Source, Maintenance and Recoverability
SOUM	Safety Of Use Message
TAMMS	The Army Maintenance Management System
TB	Technical Bulletin
TDA	Table of Distribution and Allowances
TDR	Transportation Discrepancy Report
TMDE	Test Measurement and Diagnostic Equipment
TRI	Technical/Rigger-type Inspection
UOC	Usable on Code
USL	Universal Static Line
WP	Work Package

QUALITY OF MATERIAL

Material used for replacement, repair, or modification must meet the requirements of this manual. If quality of material requirements are not stated in this manual, the material must meet the requirements of the drawings, standards, specifications, or approved engineering change proposals applicable to the subject equipment.

SAFETY, CARE AND HANDLING

The following subparagraphs summarize the safety, care and handling requirements for the parachute assembly.

Safety

Use care in handling packed parachutes as exposed metal parts could result in injury.

Care and Handling

Every effort shall be made to protect the parachute from weather elements, dust, dirt, oil, grease, and acid. An unpacked parachute shall be placed in an aviator kit bag. When available, an environmentally controlled building should be used to store parachutes. Parachutes shall be stored in a dry, well-ventilated location and protected from pilferage, dampness, fire, dirt, insects, rodents, and direct sunlight.

COMMON TOOLS AND EQUIPMENT

For authorized common tools and equipment, refer to the Modified Table of Organization and Equipment (MTOE), CTA 50-970, Expendable/Durable Items (Except Medical, Class V, Repair Parts and Heraldic Items), CTA 50-909, Field and Garrison Furnishings and Equipment or CTA 8-100, Army Medical Department Expendable/Durable Items, as applicable to your unit.

SUPPORTING INFORMATION FOR REPAIR PARTS, SPECIAL TOOLS, TMDE, AND SUPPORT EQUIPMENT

Special tools, TMDE, and support equipment are detailed in WP 0102. Refer to WP 0084 for the Illustrated List of Manufactured Items.

REPAIR PARTS AND SPECIAL TOOLS LIST (RPSTL)

Repair parts are listed and illustrated in WP 0085 through WP 0097 of this manual.

END OF WORK PACKAGE

FIELD MAINTENANCE**EQUIPMENT DESCRIPTION AND DATA**

EQUIPMENT CHARACTERISTICS, CAPABILITIES, AND FEATURES

The T-11 Personnel Parachute System is a highly portable system, which includes the main canopy assembly, the reserve canopy assembly, deployment bag, pack tray, harness assembly, risers, and universal static line modified and is capable of supporting 400 pounds. The complete system weight is 53 pounds. The T-11 Personnel Parachute System is limited to operation in winds of 13 knots or below at surface.

The T-11 Personnel Parachute System is compatible with all current military aircraft used for airborne missions and compatible with ancillary items such as the Inceptor Body Armor, MOLLE equipment and Land Warrior system.

LOCATION AND DESCRIPTION OF MAJOR COMPONENTS FOR THE T-11 PERSONNEL PARACHUTE SYSTEM**Main Canopy**

The T-11 Main Canopy (Figure 1) is a modified cruciform planform with a continuous lower lateral band. Opening characteristics are controlled through the variation of the unique geometry and deployment organizer (sleeve and slider), while utilizing low permeability (0-3 cfm), uncoated material, resulting in a high drag coefficient parachute with tolerable opening shock characteristics.

The primary usage parameters have been chosen to cope with airspeeds and drop altitudes encountered with modern aircraft and to enable the total rigged weight and rate of descent required for useful operational troop parachuting.

LOCATION AND DESCRIPTION OF MAJOR COMPONENTS FOR THE T-11 PERSONNEL PARACHUTE SYSTEM - CONTINUED

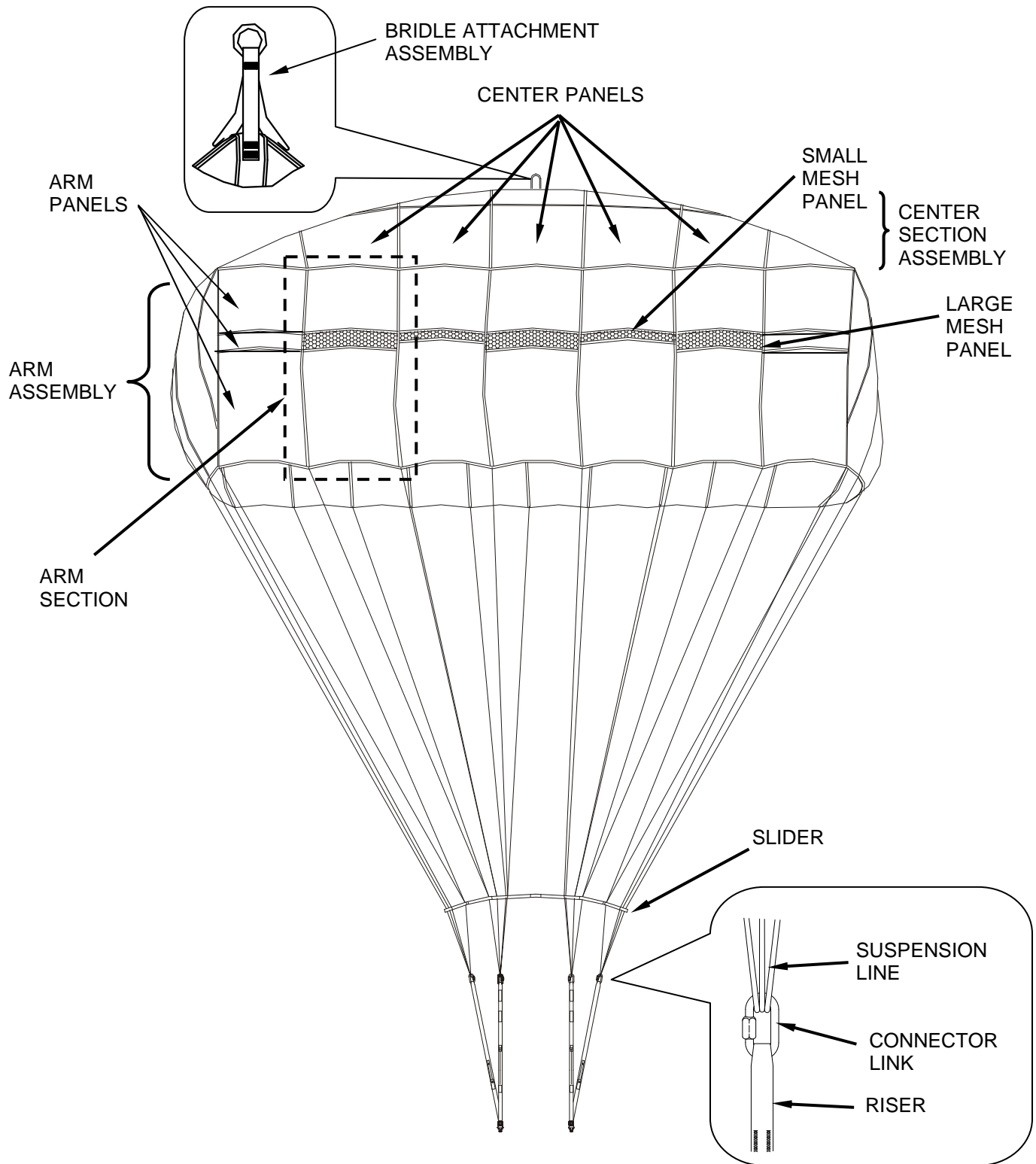

Figure 1. Main Canopy.

LOCATION AND DESCRIPTION OF MAJOR COMPONENTS FOR THE T-11 PERSONNEL PARACHUTE SYSTEM – CONTINUED**Slider**

The slider (Figure 2) is composed of two principal elements: a mesh center section and a peripheral section constructed of eight identical panels joined together. The panels are made of Type IV nylon cloth. Three #0L grommets are set on the outer edge of each panel. Additionally, four smaller panels are positioned on the slider to align with each of the four corner lines. Each of the four smaller panels has a #0L grommet on the outer edge of the panel. All suspension lines are routed from the lower lateral band through individual #0L stainless steel grommets and connected to the appropriate connector link on the riser. Airflow passes through the mesh and up into the canopy (Figure 1). The slider opens, separating the suspension lines (Figure 1). When canopy fully inflates, the slider rides down to rest just above the risers.

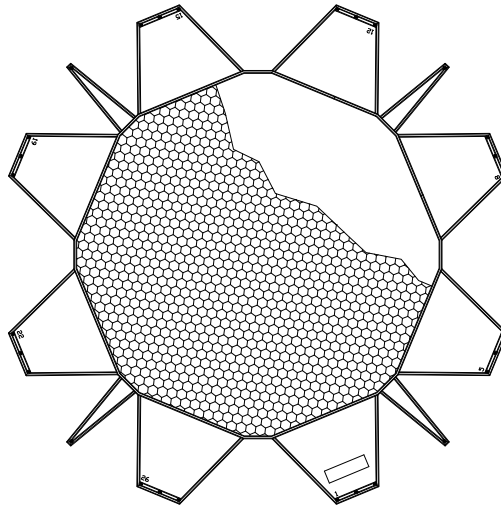

Figure 2. Slider.

Drogue Parachute

The drogue parachute (Figure 3) is a 48-inch diameter flat circular parachute made from 1.5 ounce ripstop nylon cloth. The drogue is attached to the top of the deployment sleeve (Figure 4) and provides additional drag to pull the sleeve off during the initial elongation phase.



Figure 3. Drogue Parachute.

LOCATION AND DESCRIPTION OF MAJOR COMPONENTS FOR THE T-11 PERSONNEL PARACHUTE SYSTEM – CONTINUED

Deployment Sleeve

The 19-foot cotton deployment sleeve (Figure 4) protects the entire canopy (Figure 1) during the initial phase of the opening sequence and aligns it in the airflow before inflation starts.



Figure 4. Deployment Sleeve.

Bridle Assembly

The 10-foot bridle line assembly (Figure 5) connected to the bridle ring retains the deployment sleeve (Figure 4) and drogue (Figure 3) after canopy extraction. The bridle line (Figure 5) allows fast retraction of the deployment sleeve (Figure 4) but prevents the drogue (Figure 3) from entangling with the corner vents of main canopy (Figure 1) after canopy inflation.

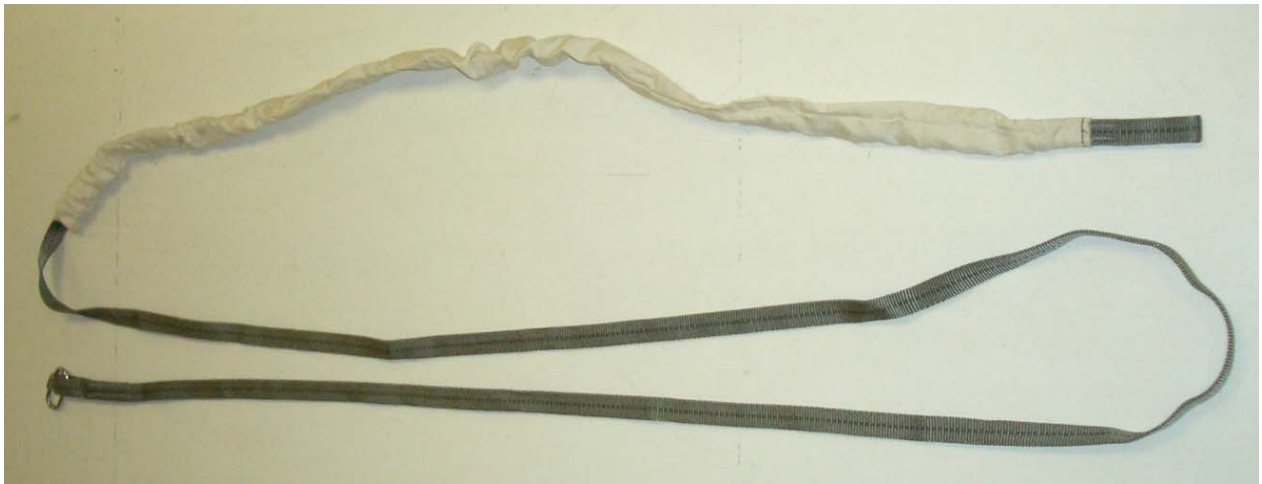

Figure 5. Bridle Assembly.

LOCATION AND DESCRIPTION OF MAJOR COMPONENTS FOR THE T-11 PERSONNEL PARACHUTE SYSTEM – CONTINUED

Main Pack Tray

The main pack tray (20 x 16 x 14 inches) (Figure 6) is constructed of duck textured nylon fabric, and consists of the following:

1. Pack closing flaps (four) (Figure 6, Item 1): right and left side flaps, and upper and lower flaps with reinforcement material sewn into pack closing flaps. Each flap contains one grommet.
2. Static line stow bars (inner and outer) (Figure 6, Item 2 and Item 3).
3. Static line slack retainer loop with retainer band (Figure 6, Item 4).
4. Waistband adjuster panel (Figure 6, Item 5).
5. Metal adjuster (Figure 6, Item 6).
6. Waistband (43 inches long) (Figure 6, Item 7).
7. Main closing loop (Figure 6, Item 8) (Spectra® 1000 loop with nylon retaining tab used to secure pack closing flaps and is held in place with curved pin).
8. Two diagonal back strap retainers (Figure 6, Item 9) sewn into upper center of pack tray for use with sizing channels on T-11 harness assembly.
9. Two diagonal back strap keepers (Figure 6, Item 12) sewn into upper center of pack tray, used with the diagonal back strap retainers.
10. Horizontal back strap retainer (two) with directional snap fasteners (Figure 6, Item 10).
11. Horizontal back strap keeper (Figure 6, Item 11).

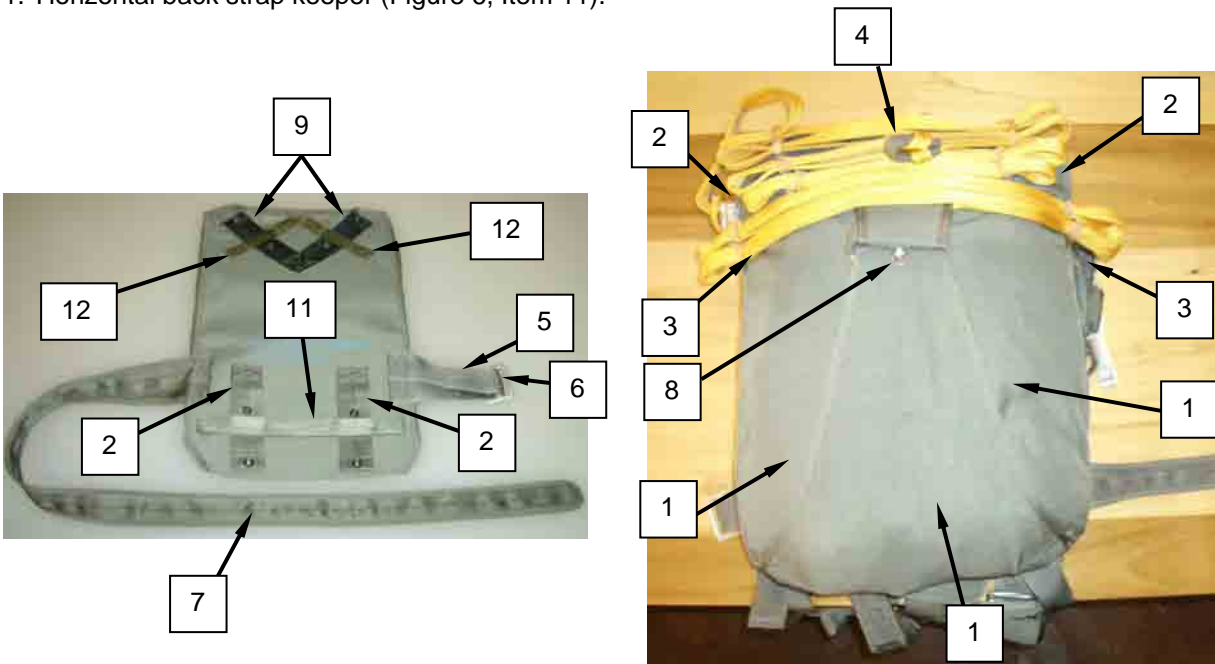

Figure 6. Main Pack Tray.

LOCATION AND DESCRIPTION OF MAJOR COMPONENTS FOR THE T-11 PERSONNEL PARACHUTE SYSTEM – CONTINUED

Harness Assembly

The harness assembly (Figure 7) is made of Type VII nylon webbing and consists of right and left upper main lift web assemblies and the lower saddle assembly. The harness assembly design allows for multi-directional adjustment. The components attached to it are as follows:

Canopy release assembly (CRA) (Figure 7, Item 1) female fittings are permanently mounted to the harness assembly. They consist of a hinged latch and safety cover with wire lanyard that closes over and secures the male fitting canopy release assembly.

Four comfort pads, two shoulder pads (Figure 7, Item 2), and two L-shaped leg ejector snap pads (Figure 7, Item 3) under the leg strap ejector snaps (Figure 7, Item 13) are permanently attached to the right and left upper main lift web assemblies beneath the diagonal back straps (Figure 7, Item 4).

The diagonal back strap has five sizing channels (Type VII webbing) (Figure 7, Item 5) sewn into the harness assembly above the reserve attaching D-rings (Figure 7, Item 6).

Two main lift web tuck tab assemblies (Figure 7, Item 7) are sewn into the harness assembly directly below the reserve attaching D-rings (Figure 7, Item 6). The adjustment assemblies consist of Type VII (reinforced with Type VIII) webbing and a 1 ¾-inch main lift web adjuster (Figure 7, Item 8) rated at 2,500 pounds.

Main lift web (Figure 7, Item 19) is constructed of Type VII nylon webbing with a rated capacity of 5,500 pounds.

Chest straps (Figure 7, Item 9) are made of Type VII nylon webbing and have a 2-inch friction adapter rated at 2,500 pounds. Two elastic webbing retainers used for stowing excess webbing.

D-rings (Figure 7, Item 6) used for attaching the T-11 Reserve are located directly below the canopy release assembly (Figure 7, Item 1), and have a rated capacity of 5,000 pounds.

Equipment D-rings (Figure 7, Item 10) used for attaching the combat equipment, with a rated capacity of 2,500 pounds.

Triangle links (Figure 7, Item 11) are sewn into the main lift web of the harness assembly (about 8 inches below the equipment rings). They are rated at 500 pounds and are used for attaching equipment and lowering lines.

Leg straps (Figure 7, Item 12) have ejector snaps (Figure 7, Item 13) with activating lever, ball detent, and opening gate with a rated capacity of 2,500 pounds.

An "L" shaped ejector snap pad (Figure 7, Item 3) is attached behind the ejector snap (Figure 7, Item 13) (the pad also attaches behind the main lift web locking adapter).

The quick-fit V-ring (Figure 7, Item 14) has a rated capacity of 2,500 pounds (Figure 7, Item 15).

Six elastic webbing retainers (Figure 7, Item 15) are used for stowing excess webbing.

Lower saddle assembly (Type VII nylon) (Figure 7, Item 16) with two attached leg straps.

Back strap adjusters (Figure 7, Item 17) and elastic webbing retainer are used for adjusting the horizontal back straps, and stowing excess webbing.

Adjustment Points. The harness assembly has nine adjustment points: the chest strap (Figure 7, Item 9), two diagonal back strap sizing channels (Figure 7, Item 5), two main lift web tuck tab assemblies (Figure 7, Item 7), two leg straps (Figure 7, Item 12), and two horizontal back straps (Figure 7, Item 18).

LOCATION AND DESCRIPTION OF MAJOR COMPONENTS FOR THE T-11 PERSONNEL PARACHUTE SYSTEM – CONTINUED

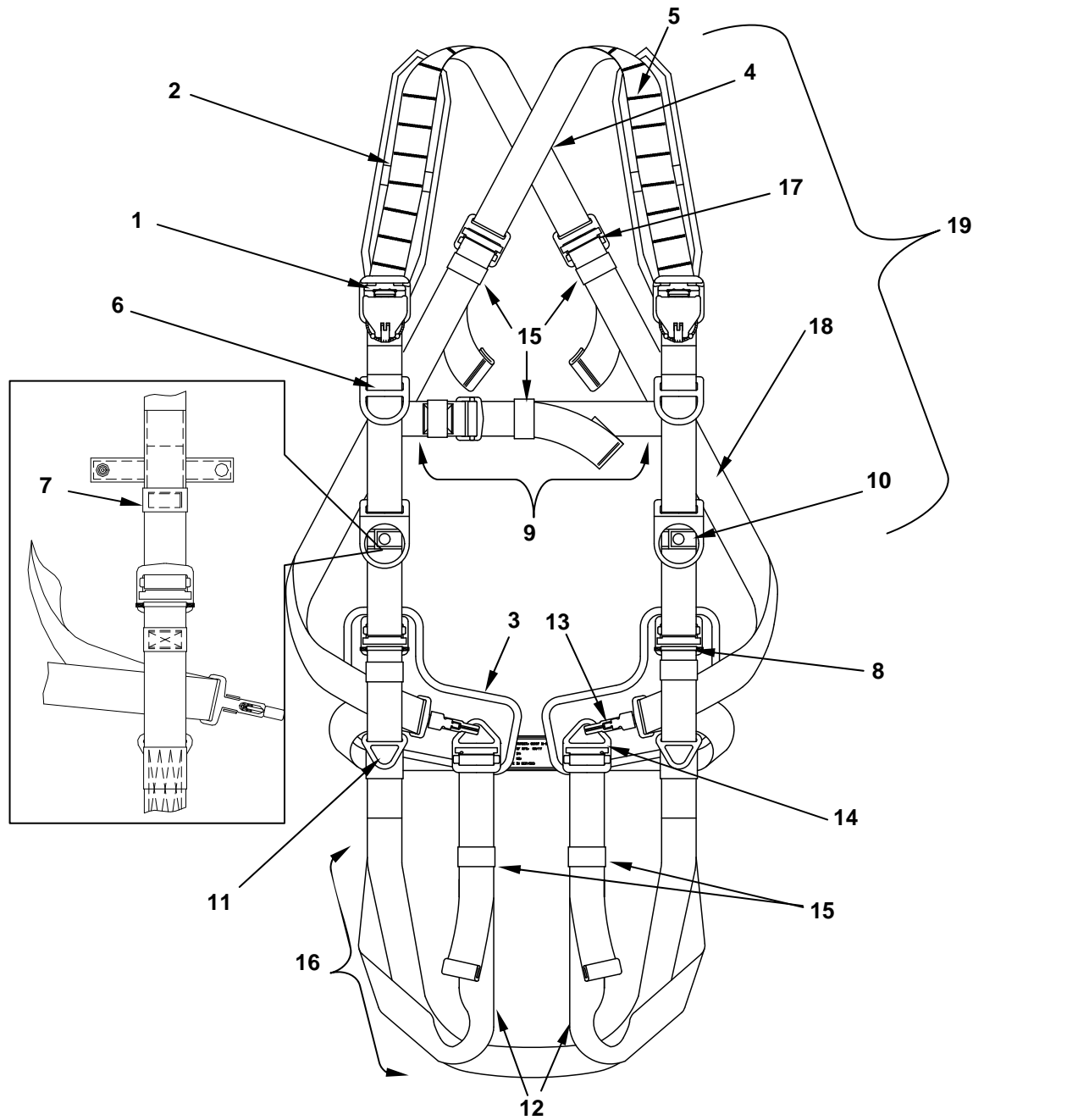

Legend:

- | | | |
|--|---------------------------|----------------------------|
| 1. Canopy release assembly (CRA) | 8. Main lift web adjuster | 14. Quick-fit V-ring |
| 2. Shoulder pads | 9. Chest strap | 15. Webbing retainers |
| 3. Leg ejector snap pads | 10. Equipment D-rings | 16. Lower saddle assembly |
| 4. Diagonal back straps | 11. Triangle links | 17. Back strap adjusters |
| 5. Diagonal back strap sizing channels | 12. Leg straps | 18. Horizontal back straps |
| 6. Reserve attaching D-rings | 13. Ejector snap | 19. Main Lift Web |
| 7. Main lift web tuck tab assemblies | | |

Figure 7. Harness Assembly and Nomenclature.

LOCATION AND DESCRIPTION OF MAJOR COMPONENTS FOR THE T-11 PERSONNEL PARACHUTE SYSTEM – CONTINUED**Main Riser Assembly**

The main riser assembly (Figure 8) consists of the following:

Two risers (Figure 8), with a finished length of 28 inches (Type VII nylon) and a tensile strength of 5,500 pounds. When attached to the canopy, the riser assemblies provide four individual risers.



Figure 8. Main Riser Assembly.

LOCATION AND DESCRIPTION OF MAJOR COMPONENTS FOR THE T-11 PERSONNEL PARACHUTE SYSTEM – CONTINUED

Deployment Bag

The T-11 main parachute is packed in the deployment bag (Figure 9). The deployment bag is constructed of nylon duck cloth.

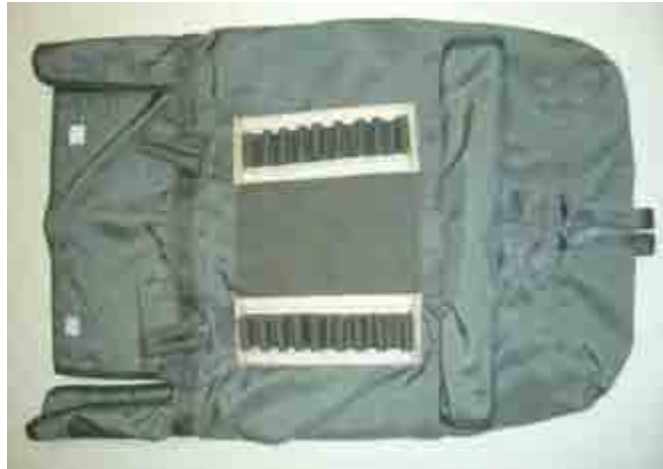

Figure 9. Deployment Bag.

Universal Static Line Modified (With Curved Pin)

The main static line (Figure 10, Item 1) is a modified 15-foot USL that contains a curved pin inside a protective cover (Figure 10, Item 2). The USL extension (Figure 10, Item 3) is 5-feet long. The USL snap hook (Figure 10, Item 4) is attached to either the Universal Static Line Modified (with Curved Pin) or the USL extension. The static line protective sleeve (Figure 10, Item 5) keeps the static line from getting damaged during deployment

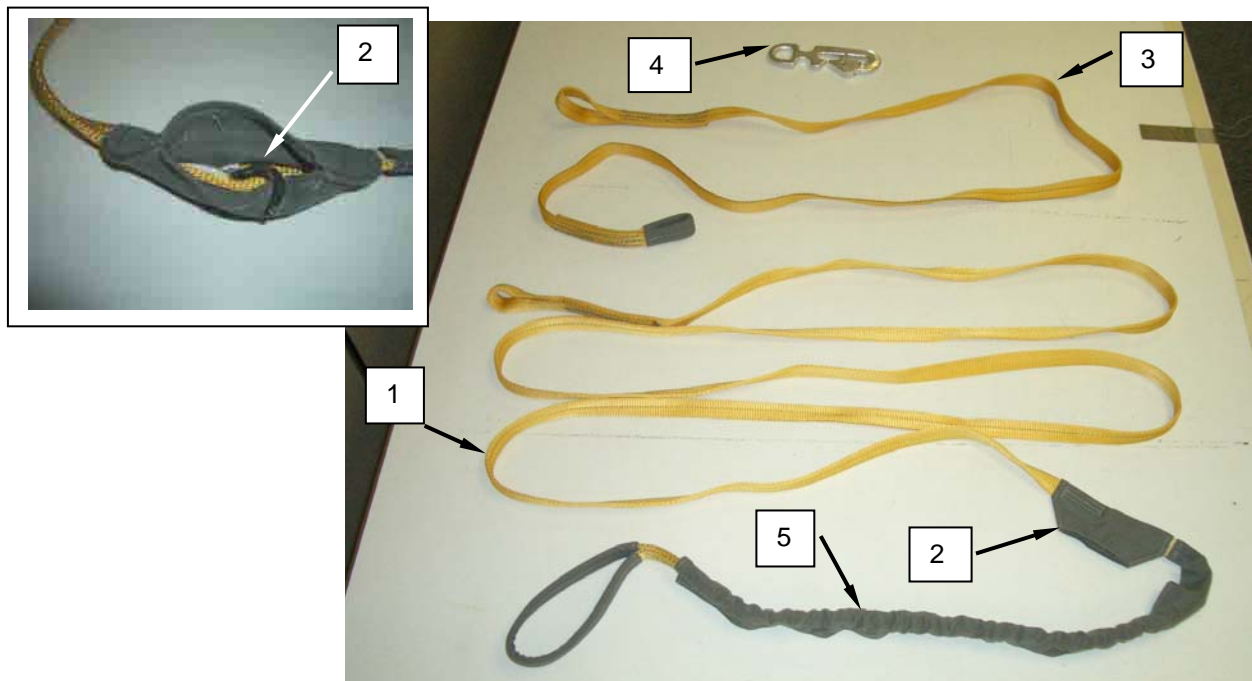

Figure 10. Universal Static Line Modified (with Curved Pin).

LOCATION AND DESCRIPTION OF MAJOR COMPONENTS FOR THE T-11 RESERVE

Reserve Canopy

The T-11 Reserve (Figure 11, Item 1) is an aeroconical design. Designed to open rapidly with a minimum post inflation collapse, the T-11 Reserve features minimum altitude loss. The designed shape resists malfunctions, such as a line over and, in its event, tends to release the line. The risk of air stealing by a malfunctioned main parachute is reduced as the T-11 Reserve, with its short system length, flies with its lower lateral band even with the hem of the main parachute. Tests have proven this to be highly successful with the reserve controlling the descent even with a fully inflated main parachute.

The T-11 Reserve has been designed to give the maximum permitted opening load at the maximum permitted speed, thus minimizing altitude loss to a safe total speed.

The T-11 Reserve is constructed to be as lightweight as possible. The lightweight construction is also necessary to allow the reserve to align with the airflow at low speeds. In the case of a low speed malfunction, such as some main canopy damage, the reserve will rise and inflate faster.

Scoops and Apex Ties

The scoops (Figure 11, Item 2) are formed by four downward pockets constructed around the upper lateral band of the parachute. The gores of the reserve between the pockets are fitted with small loops, which are drawn together with a break tie during packing. The scoops thus formed, when they are inflated, are also too large to get between the suspension lines of the malfunctioned main parachute.

The apex vent (Figure 11, Item 3) of the reserve parachute is also closed during packing using a break tie. These ties restrict the flow of air through the canopy, thus causing the fastest possible opening at slow speeds. When fully inflated the tie breaks, allowing air to flow through the canopy, reducing excessively hard openings and promotes the fastest possible opening at slow speeds.

LOCATION AND DESCRIPTION OF MAJOR COMPONENTS FOR THE T-11 RESERVE - CONTINUED

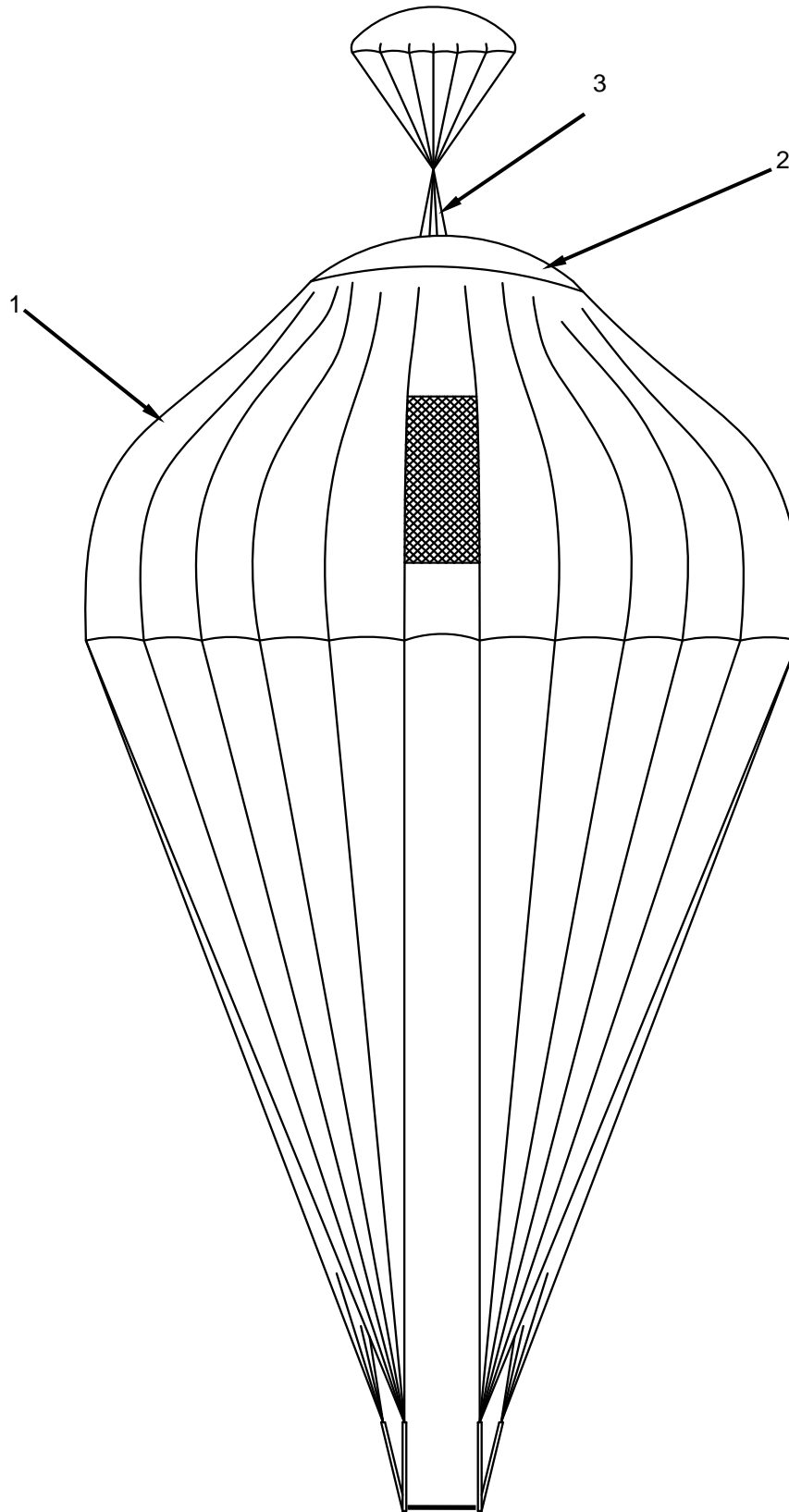

Figure 11. T-11 Reserve Parachute Assembly.

LOCATION AND DESCRIPTION OF MAJOR COMPONENTS FOR THE T-11 RESERVE - CONTINUED

Skirt Assist Ties

In order to continue to promote fast opening of the reserve parachute during low speed malfunction, skirt assist lines (Figure 12) are attached to the canopy, with Type I, ¼-inch cotton webbing between the main seam and a point on the suspension line. When the lines are together, as in before the canopy begins to inflate, the load path is along the main seam, the skirt assist lines, and the suspension lines, since this is the shortest path. Since tension in the parachute during early part of the deployment is transmitted down the skirt-assist line, the skirt is free to move outwards in the airflow, which promotes faster inflation by forming a funnel.

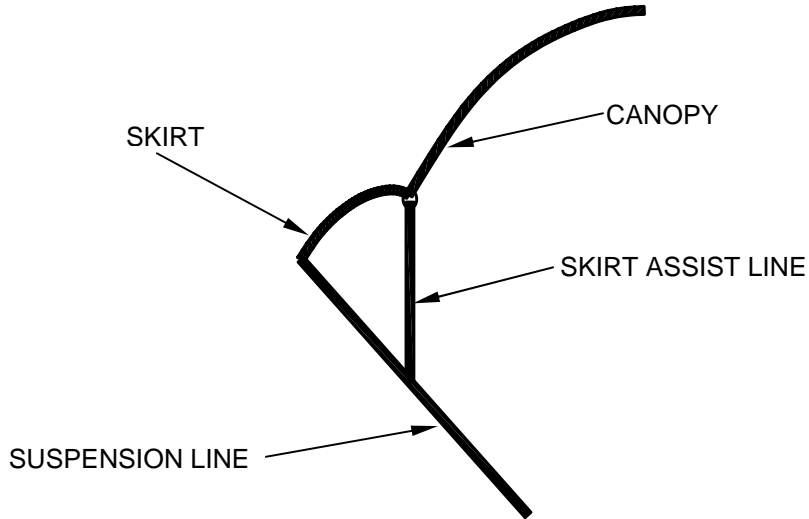

Figure 12. Skirt Assist Lines at Low Speed.

At high speed, the load is such that the skirt assist tie will break, reapplying the tension to the lower lateral band and prevent the funneling effect (Figure 13). The canopy then inflates in a conventional manner.

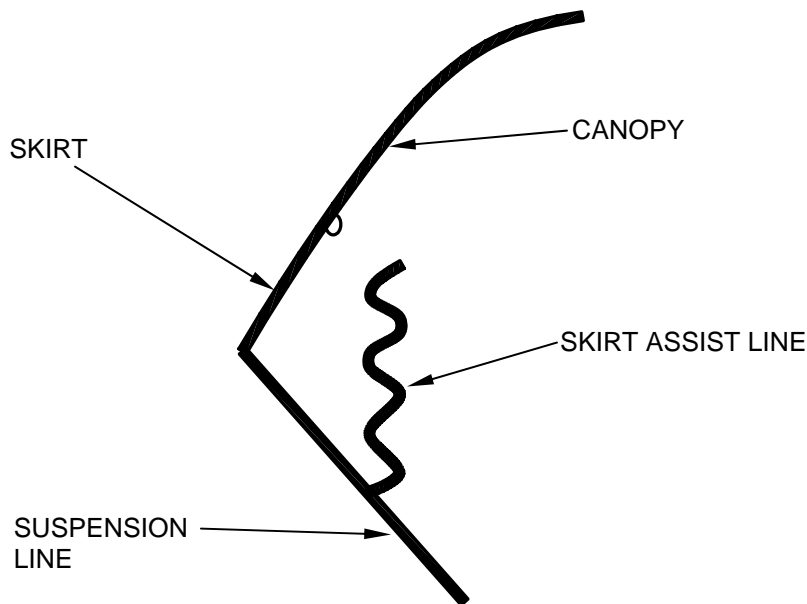

Figure 13. Skirt Assist Lines at High Speed.

LOCATION AND DESCRIPTION OF MAJOR COMPONENTS FOR THE T-11 RESERVE - CONTINUED**Ejector Spring Assembly**

A "boxed" and vented ejector spring (Figure 14) is packed one-third of the distance from the apex to the lower lateral band within the canopy folds. This ensures that upon pack opening, the primary extractor parachute and the apex of the canopy, with the scoops, are ejected positively and laterally into the airflow. The extractor parachute and the scoops inflate immediately to extract the S-folded canopy from the container to present the canopy into the airflow.



Figure 14. Ejector Spring Assembly.

Reserve Ripcord Assembly

The T-11 Reserve ripcord assembly (Figure 15) is designed as a multi-directional pull and centrally mounted soft handle.



Figure 15. Ripcord Assembly (Handle Side).

The ripcord assembly design incorporates a soft handle. In the event of an entanglement, this minimizes the snagging hazard, permitting suspension lines to run freely over the ripcord assembly without removing it from its stowage. The tuck tab design regulates the pull force required to remove the assembly from the stowage.

LOCATION AND DESCRIPTION OF MAJOR COMPONENTS FOR THE T-11 RESERVE - CONTINUED

Two curved pins (Figure 16, Item 1) are attached to a length of 600-pound Dacron® line and stitched to the ripcord assembly. The curve of the two pins is configured in opposite directions so that the pull load remains consistent regardless of the pull direction. In addition, the use of a curved pin minimizes the risk of the pin being pushed out of the closure loop. Additionally, the tuck tab configuration (Figure 16, Item 2) has the advantage of preventing the reserve canopy from deploying if the curved pins are inadvertently removed from the closing loops.

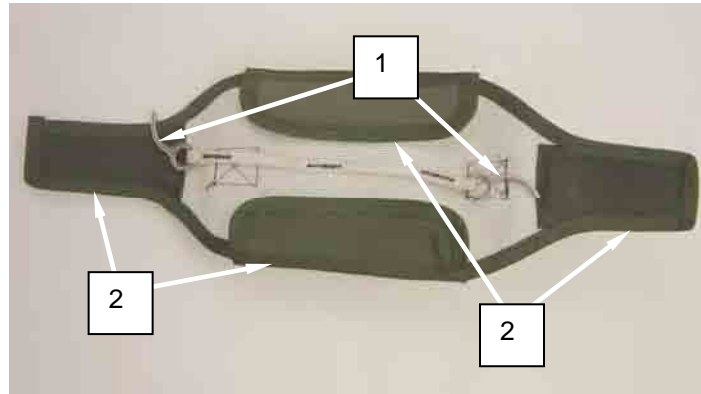

Figure 16. Ripcord Assembly (Underside).

Extractor

The reserve extractor (Figure 17) is a 6-foot diameter flat canopy manufactured from 1.5 ounce ripstop fabric. It has 12 suspension lines and a center line. The extractor is attached to the apex of the reserve with Spectra® 1000 cord.



Figure 17. Extractor.

LOCATION AND DESCRIPTION OF MAJOR COMPONENTS FOR THE T-11 RESERVE - CONTINUED**Reserve Pack Tray**

The reserve pack tray (Figure 18) is designed to reduce the profile and give the jumper added vision as he looks down and prepares for landing. The pack is manufactured from nylon duck cloth and is stiffened with a wire frame. Inside the pack tray, elastic loops accommodate the reserve risers when packed. Grommets along the upper edge allow the spreader bar to be secured between the connector snaps.



Figure 18. Reserve Pack Tray.

Reserve Risers

The reserve risers (Figure 19, Item 1) are 48 inches long, Type VIII nylon webbing. The risers have a 15-inch length of hook and pile fastener tape positioned between the front and rear to prevent riser offset during high speed deployments. A spreader bar (Figure 19, Item 2) is positioned between the connector snaps to ensure proper separation is maintained between the risers. The risers are left and right handed because of the left/right reserve connector snaps positioned on the lower end of each riser.

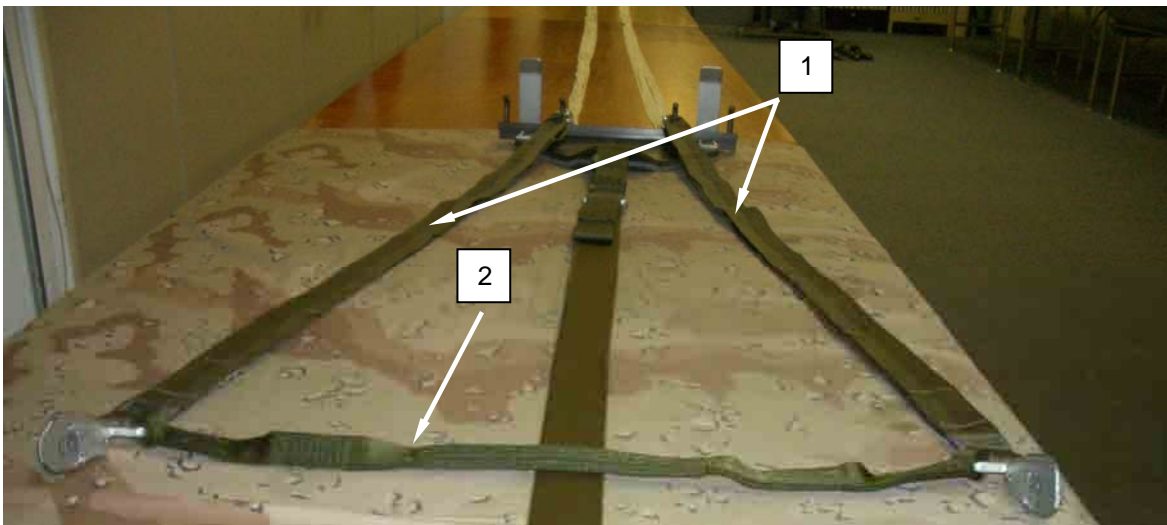

Figure 19. Reserve Risers.

LOCATION AND DESCRIPTION OF MAJOR COMPONENTS FOR THE T-11 RESERVE - CONTINUED**Protection Cap**

The reserve protection cap (Figure 20) is 6 inches in diameter and manufactured from nylon duck cloth. During the parachute packing process, it is placed on top of the folded canopy, providing protection from the pack tray closing flaps.



Figure 20. Protection Cap.

Reserve Closing Loop

The reserve closing loop (Figure 21, Item 1) is manufactured from Spectra® 700 cord. It is a prefabricated loop that is fitted to the base of the reserve ejector spring. The length of the loop is regulated to control the pull force on the ripcord assembly curved pins.

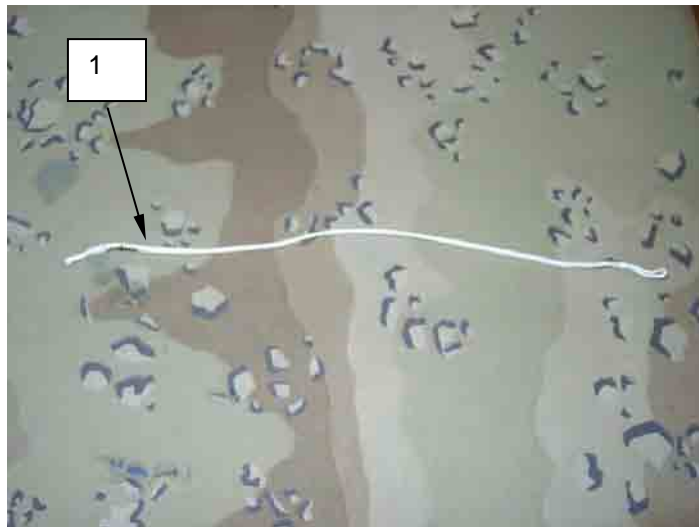

Figure 21. Reserve Closing Loop.

EQUIPMENT DATA T-11 PERSONNEL PARACHUTE SYSTEM - CONTINUED

Equipment Data for T-11 Reserve Parachute

Shape	Aeroconical
Diameter (nominal)	29 feet
Diameter of Skirt	20.2 feet
T-11 Reserve with Pack Tray Dimensions (packed for use)	Length – 12 inches
	Width – 15 inches
	Height – 8 inches
T-11 Reserve with Pack Tray Cube (packed for use)	1 ft ³
T-11 Reserve with Pack Tray Weight (packed for use)	14.8 pounds
Maximum Deployment Speed	150 KIAS
Maximum Deceleration for 382 pounds at 150 KIAS	11 g
Maximum Rate of Descent for 382 pounds at Mean Sea Level	26 feet per second
Maximum Opening Time for 382 pounds at 150 KIAS	0.7 seconds
Oscillation Angle	9 degrees
Repack Cycle	365 days
Fabric Area	180 square feet
Apex Vent Area	3.5 square feet
Suspension Line Length	20.3 feet
Number of Suspension Lines	20
Number of Gores	20
Number of Panels per Gore	4 or 5
Gore Material (Panels 1, 2, 3)	Cloth, Parachute, Nylon, Low Permeability, Type IV, FG504
Gore Material (Panels 4, 5)	Cloth, Parachute, Nylon, low Permeability, Type VI, 1.5 ounce per square yard, Color FG 504
Vent Panel Material	Netting, Style 9404, Nylon, ¼-inch, Hex Opening
Number of Main Tapes	20
Geometric Porosity	7%
Main Seam Material	9/16-inches, Type I, Nylon Webbing
Suspension Line Material	Cord, Nylon, 650 pounds, Class F (Anti-friction coated)
Number of Connector Links	Four Links #6 Stainless Steel
Number of Scoops	4
Scoops Material	Cloth, Parachute, Nylon, Low Permeability, Type IV, FG 504
Number of Skirt Assist Lines	20
Number of Skirt Assist Line Ties	20

Extractor Assembly

Diameter	6 feet
Material	1.5-ounce Nylon, Ripstop
Number of Suspension Lines	12
Number of Centering Lines	1
Number of Bridle Lines	4
Bridle Line Material	Webbing, 9/16-inches, Type I, CL2, FG504

Main Pack Tray

Container Material	Cloth, Duck, Textured Nylon, 7.25 ounce
Main Closing Loop Material	Cord, Spectra® 700 pounds

Reserve Pack Tray

Container Material	Cloth, Duck, Textured Nylon, 7.25 ounce
Reserve Closing Loop Material	Cord, Spectra® 700 pounds
Reserve Closing Loop Length	12 inches, +/- ¼-inch

EQUIPMENT DATA T-11 PERSONNEL PARACHUTE SYSTEM - CONTINUED

Harness Assembly

Strap Material Type VII, nylon webbing

Deployment Bag

Bag Material nylon duck cloth

Main Riser Assembly

Material Type VII, nylon webbing
Length 30 inches

Reserve Risers

Material Type VIII, Class IA
Length 48 inches

Universal Static Line Modified (With Curved Pin)

Material Webbing, Nylon, Tube Edge
Length 15 feet

Universal Static Line Extension

Material Webbing, Nylon, Tube Edge
Length 5 feet

Universal Static Line Snap Hook (1)

Material Type 4140 Steel
Length 6 inches

DECALS AND INSTRUCTION PLATES

Table 1. T-11 Decals, Data Blocks, and Instruction Plates.

Decal, Data Block, or Instruction Plate	Location
	<p>Main Riser Assembly</p>

DECALS AND INSTRUCTION PLATES - CONTINUED

Table 1. T-11 Decals, Data Blocks, and Instruction Plates - Continued.

Decal, Data Block, or Instruction Plate	Location
	Reserve Riser

DECALS AND INSTRUCTION PLATES - CONTINUED

Table 1. T-11 Decals, Data Blocks, and Instruction Plates - Continued.

Decal, Data Block, or Instruction Plate	Location
 <p> 32 FT NOMINAL DIAMETER DATE PLACED IN SERVICE: 07/11/05 CONTRACT NO: W55P05-04-C-0012 DATE OF MANUFACTURE: 04/05 SERIAL NO: 115 411 10 CAGE CODE: 05QR4 </p> 	<p>Main Canopy Gore</p>

DECALS AND INSTRUCTION PLATES - CONTINUED

Table 1. T-11 Decals, Data Blocks, and Instruction Plates - Continued.

Decal, Data Block, or Instruction Plate	Location
	<p>Harness Assembly</p>

END OF WORK PACKAGE

FIELD MAINTENANCE**THEORY OF OPERATION**

GENERAL

The T-11 Personnel Parachute System is a two-part parachute system comprised of both the T-11 main parachute and the T-11 Reserve parachute.

The T-11 Personnel Parachute System was developed to satisfy the high priority airdrop requirement to reduce parachutist injuries in parachuting operations.

In a typical combat mission, troops drop from as low as 500 feet Above Ground Level (AGL), and at aircraft speeds between 130-150 Knots Indicated Airspeed (KIAS). In this operational profile, rate of descent is highly critical. The T-11 Personnel Parachute System main parachute has a rate of descent of between 14.5 and 18.5 FPS depending on the jumper's total weight and drop altitude. This yields a 40 percent reduction in impact energy and is expected to reduce landing injuries significantly. Injuries upon landing reduce the combat effectiveness of the assaulting element and require otherwise combat effective soldiers to assist those injured.

The T-11 Personnel Parachute System also incorporates an advanced reserve parachute and harness assembly. The T-11 Reserve parachute provides a rate of descent of 26 FPS. The T-11 Reserve harness assembly attachment points align the parachute opening forces along the long axis of the jumper's body.

T-11 Personnel Parachute System

During use, it is located on the back of the parachutist. Opening of the main canopy is controlled by its shape. The parachute does not have any forward speed and will have a ballistic descent once stable in a no-wind direction.

Main Parachute Harness Assembly

The main parachute harness assembly has nine adjustment points. Changing the settings on the two adjusters located at the shoulder of the harness assembly accommodates individual chest sizes. The two main lift web adjustments are to accommodate individual torso length. The chest strap adjusts for chest size. The diagonal backstraps adjust to accommodate girth and saddle length. The sizing channels adjust parachute fit.

T-11 Reserve Parachute

The T-11 Reserve parachute is a chest mounted ripcord center pull reserve parachute. In an emergency situation, the T-11 Reserve parachute may be deployed with either hand under the following conditions:

1. Fully deployed main parachute
2. Partially deployed main parachute (partial malfunction)
3. Total malfunction

MAIN PARACHUTE DEPLOYMENT SEQUENCE

Activation begins with the static line connected to the aircraft anchor line cable and the jumper exiting. The static line tightens as the jumper falls away from the aircraft, pulling the main curved pin from the main closing loop. The static line is connected to the deployment bag as the jumper continues to fall away from the aircraft. Two ¼-inch cotton webbing ties, one on each riser group holding the risers and lines in place, break. After the suspension lines pull out of the suspension line stow loops, the suspension lines pull out of the deployment bag locking stow loops, opening the bag mouth. The drogue and deployment sleeve with the enclosed canopy emerges from the deployment bag. The drogue and deployment sleeve catch air causing the sleeve to pull off the main canopy exposing the lower lateral band with slider at the mouth of the canopy.

MAIN PARACHUTE DEPLOYMENT SEQUENCE - CONTINUED

As the jumper transitions from a horizontal to vertical orientation, the deployment sleeve completely comes off the canopy, but remains at the apex of the canopy along with the drogue due to the 10-foot bridle line attached at the apex of the canopy, routed through the deployment sleeve, and connected to the drogue. The slider controls the lower lateral band opening of the canopy, and descends from the lower lateral band along the suspension lines to above the connector links as the canopy becomes stable. Additionally, the slider eliminates line-over malfunctions, and enhances opening characteristics.

RESERVE PARACHUTE DEPLOYMENT SEQUENCE

Upon activation by means of the ripcord assembly, the curved pins are extracted. From this point on, the parachutist has nothing to do in order to ensure or enhance the performance of the reserve system. Following pin extraction, the ejection spring parts the flaps of the container launching a protection cap from the solid flat base and places the top portion of the parachute with its associated extraction and assist system away from the parachutist and into clean air flow. Both the extractor parachute and the scoops inflate almost immediately and carry first the 'S' folded canopy and then the lines from the tray up and alongside the malfunctioned main parachute (if present).

The T-11 Reserve parachute responds differently to different situations as follows:

At Low Speed

The combination of ejector spring and double deployment system apply a positive force to the apex of the reserve canopy to expedite and control the deployment thus reducing the risk of entanglement. Tests have shown that the extractor parachute is too big when inflated, and lacks momentum (as there is no pilot parachute spring mass), to get into the main parachute line cone. The scoops operate in a similar manner.

Once aligned the open skirt is presented to the airflow. By virtue of the skirt assist lines the normal orifice for inflation is greatly enhanced allowing the funneling of air into the parachute.

At High Speed

The high drag of the lightweight extractor parachute is not required after canopy elongation. In this event the securing ties break and release the extractor parachute to go free. Moreover at line stretch, the skirt assist lines break preventing the lower lateral band from flaring prematurely, and allowing the canopy to inflate in a conventional manner.

END OF WORK PACKAGE

CHAPTER 2

PREVENTIVE MAINTENANCE CHECKS AND SERVICES (PMCS)
FOR
T-11 PERSONNEL PARACHUTE SYSTEM

FIELD MAINTENANCE

PREVENTIVE MAINTENANCE CHECKS AND SERVICES INTRODUCTION

GENERAL

The following information describes PMCS procedures on the field level. The PMCS table has been provided to ensure the T-11 Personnel Parachute System is in proper operating condition, and ready for use.

PARACHUTE REPACK INTERVAL

The T-11 Personnel Parachute System will be repacked at a scheduled interval to insure airworthiness. When necessitated by climate/storage/use condition, the local Airdrop Systems Technician (921A) or Senior Airdrop NCO (92R4P) and above, under guidance from an Airdrop Systems Technician assigned to the command may require more frequent pack intervals. In this regard, a major concern would be rapid fluctuations of temperature (fluctuations around 32 °F [0 °C]) sustained high or low temperature, or high humidity and heavily polluted atmosphere. The T-11 Personnel Parachute System main parachute will be repacked at a 120-day interval and the T-11 Reserve parachute will be repacked at a 365-day interval.

PMCS DATA**Frequency of Performing PMCS**

PMCS will be performed before equipment is packed for use, after use, after modification or repair, or at any time as directed by the local Airdrop Systems Technician (921A) or Senior Airdrop NCO (92R4P) and above, under guidance from an Airdrop Systems Technician assigned to the command at the Battalion level or higher, when no Airdrop Technician is assigned at the Company/Detachment/Team level.

PMCS Columnar Entries Table 1

Item Number. The item number column shall be used as a source of the item number required for the TM Number column on DA Form 2404 (Equipment Inspection and Maintenance Worksheet), when recording the results of the PMCS.

Interval. This column identifies the required PMCS interval.

Item to be inspected. Contains the common name of the item to be inspected.

Procedures. Provides a brief description of the procedures by which the checks are to be performed.

Recording Defects

All defects discovered during the inspection will be recorded using the applicable specifics in DA PAM 750-8 and DA PAM 738-751.

Over Age Items

During any inspection, or at any time that an item is found to be over age (i.e., shelf/service-life has expired as specified in TB 43-0002-43), the item will be removed from service, condemned, and tagged, in accordance with DA PAM 738-751.

Conservation of Resources

To conserve time and labor, unit/detachment commanders may designate, in writing, rigger personnel to accomplish classification code of over age air delivery equipment and the classification of Beyond Economical Repair (BER) parachutes.

PMCS DATA – CONTINUED**Inspection Function Requirement**

Normally, air delivery equipment maintenance personnel at a packing, rigging, or repair section activity will perform a technical/rigger-type inspection. The inspection of initial receipt items will be performed as a separate function from packing or rigging activity; the item to be inspected will be placed in proper layout on a packing table or suitable sized floor area.

Should defect or damage be discovered at any point during the inspection, the damage will be noted and the applicable item will be processed and repaired. The repair activity, in turn, will conduct a technical/rigger-type inspection that will be performed by only those parachute rigger personnel cited in AR 750-32.

Lubrication Service Intervals**NOTE**

Parachutes that are deemed unserviceable, by packing or rigging section activity, will be rigger-rolled (see the ACCORDION FOLDING/RIGGER ROLLING paragraph detailed in WP 0088) prior to being sent to a repair activity.

The T-11 Personnel Parachute System Parachute System assemblies do not require lubrication service.

Corrosion Prevention and Control (CPC)

Corrosion Prevention and Control (CPC) of Army materiel is a continuing concern. It is important that any corrosion problems with this item be reported so that the problem can be corrected and improvements can be made to prevent the problem in future items.

Corrosion specifically occurs with metals. It is an electrochemical process that causes the degradation of metals. It is commonly caused by exposure to moisture, acids, bases, or salts. An example is the rusting of iron. Corrosion damage in metals can be seen, depending on the metal, as tarnishing, pitting, fogging, surface residue, and/or cracking.

Plastics, composites, and rubbers can also degrade. Degradation is caused by thermal (heat), oxidation (oxygen), solvation (solvents), or photolytic (light, typically UV) processes. The most common exposures are excessive heat or light. Damage from these processes will appear as cracking, softening, swelling, and/or breaking.

SF Form 368, Product Quality Deficiency Report should be submitted to the address specified in DA PAM 750-8, The Army Maintenance Management System (TAMMS) Users Manual.

DROP TESTING CRITERIA

Drop testing of the T-11 Personnel Parachute System consists of physically airdropping an item from an aircraft in flight. The drop test is used as a means of proving the serviceability of an item or checking parachute rigger proficiency, and will only be performed under the supervision of qualified parachute rigger personnel who satisfy the supervisory requirements outlined in AR 750-32. Drop testing will usually be conducted by an activity responsible for the inspection and maintenance of airdrop equipment, which includes either parachute packing or airdrop load rigging. The criteria required to accomplish a drop test is as follows:

1. To drop test a troop-type personnel parachute, a qualified parachute rigger will jump the parachute or the applicable type parachute will be released under conditions that are consistent with the requirements for a personnel jump.

DROP TESTING CRITERIA - CONTINUED

2. During the drop test of any type parachute, the deployment of the parachute will be thoroughly monitored and observed to detect any indication of malfunction or defect. A subsequent record of the drop test will be entered into the notes page of the applicable log record.
3. Any type of airdrop equipment that indicates evidence of malfunction/defect during, or after a drop test will be disposed of as prescribed in WP 0011.
4. A personnel parachute that is considered to have contributed to the fatality of an individual parachutist will be disposed of in accordance with WP 0011, Equipment Disposition.
5. Airdrop equipment that does not reflect evidence of malfunction or defect upon completion of a drop test will be administered a technical/rigger-type inspection as outlined in WP 0011. If serviceable, the item(s) may then remain in use.

END OF WORK PACKAGE

FIELD MAINTENANCE

PREVENTIVE MAINTENANCE CHECKS AND SERVICES (PMCS)

INITIAL SETUP:

Tools and Special Tools

Adapter, Tension Plate (WP 0102, Item 1)
 Apex Hook (WP 0102, Item 2)
 Packing Loop Tension Device (WP 0102, Item 31)
 Plate, Tension, Parachute Packing (WP 0102, Item 36)
 Ruler, Tab, Metal 16 inches (WP 0102, Item 45)

Personnel Required

Parachute Rigger 92R1P (1)

References

WP 0007
 TB 43-0002-43

Materials/Parts

None required

Equipment Condition

Equipment will be placed in proper layout on a packing table or suitable sized floor area.

GENERAL

The following describe PMCS procedures at the field level. The PMCS table has been provided to ensure the T-11 Personnel Parachute System is in proper operating condition, and ready for its primary mission.

Table 1. Preventive Maintenance Checks and Services for T-11 Personnel Parachute System.

ITEM NO.	INTERVAL	ITEM TO BE CHECKED OR SERVICED	PROCEDURE	EQUIPMENT NOT READY/ AVAILABLE IF:
1.	Before After	T-11 Personnel Parachute System	1. Verify that system is complete IAW WP 0007.	Components are missing.
2	Before After	Deployment Bag	1. Main Bag. Inspect for holes and tears, loose or broken stitching. 2. Stow Loops and Reinforcement Panel. Inspect for loose or broken stitching, holes, tears, burns or frays. No more than two consecutive stow loops damaged. 3. Edge Reinforcement Webbing. Inspect for loose or broken stitching, holes, tears, burns or frays. 4. Side Flaps. Inspect for loose or broken stitching, holes, tears, burns or frays. 5. Suspension Line Stow Panel. Inspect for loose or broken stitching, holes, tears, burns or frays.	Presence of holes greater than 1-inch in diameter, tears and loose or broken stitching. Presence of loose or broken stitching, holes, tears, burns or frays. Two consecutive stow loops damaged, or no more than 2 stow loops per panel are damaged. Presence of loose or broken stitching, holes, tears, burns or frays. Presence of loose or broken stitching, holes, tears, burns or frays. Presence of loose or broken stitching, holes, tears, burns or frays.

GENERAL - CONTINUED

Table 1. Preventive Maintenance Checks and Services for T-11 Personnel Parachute System-Continued.

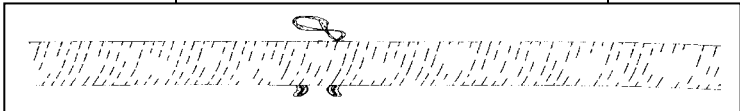
ITEM NO.	INTERVAL	ITEM TO BE CHECKED OR SERVICED	PROCEDURE	EQUIPMENT NOT READY/ AVAILABLE IF:
	Before After	Deployment Bag - Continued	6. Locking Stow Loops. Inspect for loose or broken stitching, holes, tears, burns or frays. 7. Suspension Line Protective Flap. Inspect for loose or broken stitching, holes, tears, burns or frays and illegibility of markings. 8. Deployment Bag Securing Loops. Inspect for loose or broken stitching, holes, tears, burns or frays. 9. Connector Link Tie Loops. Inspect for loose or broken stitching, holes, tears, burns or frays.	Presence of loose or broken stitching, holes, tears, burns or frays. Presence of loose or broken stitching, holes, tears, burns or frays and illegibility of markings. Presence of loose or broken stitching, holes, tears, burns or frays. Presence of loose or broken stitching, holes, tears, burns or frays.
3	Before After	Universal Static Line Modified	1. Webbing. Inspect for loose or broken stitching, holes, burns or frays. Green identification thread is present. a. Static line webbing with minor abrasions are serviceable. Minor abrasions (Figure 1) are visible on the surface of the USL webbing and will appear to look "fuzzy."	Presence of loose or broken stitching, holes, burns or frays. Green identification thread is missing.
			 <p data-bbox="690 1360 954 1392">Figure 1. Minor Abrasion.</p> b. Static line webbing with major abrasions are unserviceable. Major abrasions (Figure 2) are visible when inner core fibers are pulled through the surface of the webbing.	Presence of major abrasions. Presence of loose or broken stitching, holes, tears, burns or frays. Mark is not present.
			 <p data-bbox="690 1724 954 1755">Figure 2. Major Abrasion.</p> 2. Sleeve and Buffer. Inspect for loose or broken stitching, holes, tears, burns or frays. Inspect entire portion of static line covered by sleeve, ensuring blue mark is present.	

GENERAL - CONTINUED

Table 1. Preventive Maintenance Checks and Services for T-11 Personnel Parachute System-Continued.

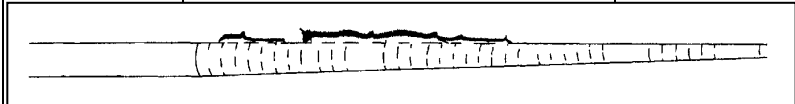
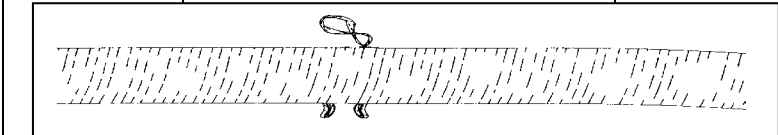
ITEM NO.	INTERVAL	ITEM TO BE CHECKED OR SERVICED	PROCEDURE	EQUIPMENT NOT READY/ AVAILABLE IF:
	Before After	Universal Static Line Modified - Continued	3. Curved Pin. Inspect for rust, burrs, corrosion, sharp edges, bent or twisted pins. 4. Curved Pin Cover. Inspect for loose or broken stitching, holes, line extension tears, burns or frays. 5. Main Curved Pin Matching Loop. Inspect for loose or broken stitches, burns, frays and tears. 6. Snap Hook. Inspect for proper operation, excessive wear, rust, burrs, corrosion, and cracks.	Presence of rust, burrs, corrosion, or bent or twisted pins. Presence of loose or broken stitching, holes, line extension tears, burns or frays. Presence of loose or broken stitches, burns, frays and tears. Presence of excessive wear, rust, burrs, corrosion, and cracks. Snap hook doesn't operate properly.
4	Before After	Extension, Universal Static Line, (USL)	1. Webbing. Inspect for loose or broken stitching, holes, burns or frays. Green identification thread is present. a. Static line webbing with minor abrasions are serviceable. Minor abrasions (Figure 3) are visible on the surface of the USL webbing and will appear to look "fuzzy."	Presence of loose or broken stitching, holes, line extension tears, burns or frays. Green identification thread is missing.
			Figure 3. Minor Abrasion.	
			b. Static line webbing with major abrasions are unserviceable. Major abrasions (Figure 4) are visible when inner core fibers are pulled through the surface of the webbing.	Presence of major abrasions.
			Figure 4. Major Abrasion.	
5	Before After	Bridle Line	1. Bridle Line. Inspect for burns, cuts, breaks, and loose or broken stitching. 2. Bridle Line Connector Link. Inspect for sharp edges, burrs, rough spots, corrosion, cracks and bends and proper operation.	Presence of burns, cuts, breaks, and loose or broken stitching. Presence of sharp edges, burrs, rough spots, corrosion, cracks, bends, connector link inoperable.

GENERAL - CONTINUED

Table 1. Preventive Maintenance Checks and Services for T-11 Personnel Parachute System-Continued.

ITEM NO.	INTERVAL	ITEM TO BE CHECKED OR SERVICED	PROCEDURE	EQUIPMENT NOT READY/ AVAILABLE IF:
6	Before After	Deployment Sleeve	1. Deployment Sleeve. Inspect the sleeve for dampness, dirt, foreign material, holes, cuts, snags, tears, frays, burns, loose or broken stitching, and marred or illegible markings. 2. Hook and Pile Tape Assembly. Ensure that it mates and engages.	Presence of dampness, dirt, foreign material, holes greater than 1-inch in diameter or holes within 12 inches of another, cuts, snags, tears, frays, burns, loose or broken stitching, and marred or illegible markings. Doesn't mate and engage.
7.	Before After	Main Canopy	1. Drogue Parachute. Inspect the drogue parachute for holes, cuts, frays, tears, burns, and loose or broken stitching. Ensure there are no more than one hole per mesh section. Ensure holes in mesh material do not exceed 1 inch in diameter. Inspect for legible markings on data plate. 2. Bridle Attachment Assembly. Check for cuts, and loose or broken stitching. Check ring for sharp edges, burrs, rough spots, corrosion, cracks, and bends. 3. Reinforcement Panels. Inspect for holes, cuts, frays, tears, burns, and loose or broken stitching. 4. Main Seams and Cross Seams. Inspect for loose and broken stitching, holes and tears. 5. Pack Loops. Inspect for loose or broken stitching, frays, holes, tears, burns, and cuts. 6. Pack Tabs. Inspect for loose or broken stitching, frays, holes, tears, burns, and cuts. 7. Center Section. Inspect for loose or broken stitching, frays, holes, tears, burns, and cuts. 8. Arm Assemblies. Inspect for loose or broken stitching, holes, tears, frays, burns and cuts. 9. Main Canopy Data Blocks. Inspect for legibility of data. Check placed-in-service date and date of manufacture.	Presence of holes, cuts, frays, tears, burns, and loose or broken stitching. More than one hole per mesh section. Holes in mesh material do not exceed 1 inch in diameter. Data illegible. Presence of loose or broken stitching, broken lines, broken core cords, frays, burns, and tears. Presence of sharp edges, burrs, rough spots, corrosion, cracks, and bends. Presence of holes, cuts, frays, tears, burns, and loose or broken stitching. Presence of loose and broken stitching, holes and tears. Presence of loose or broken stitching, frays, tears, burns, and cuts. Presence of loose or broken stitching, frays, tears, burns, and cuts. Presence of loose or broken stitching, frays, tears, burns, and cuts. Presence of loose or broken stitching, holes, tears, frays, burns and cuts. Data missing or illegible. Beyond service/shelf life based on TB 43-0002-43.

GENERAL - CONTINUED

Table 1. Preventive Maintenance Checks and Services for T-11 Personnel Parachute System-Continued.

ITEM NO.	INTERVAL	ITEM TO BE CHECKED OR SERVICED	PROCEDURE	EQUIPMENT NOT READY/ AVAILABLE IF:
	Before After	Main Canopy - Continued	<p>10. Lower Lateral Band. Inspect for loose or broken stitching, rips, snags, and burns.</p> <p>11. Suspension Line Attaching Loops. Inspect for cuts, breaks, frays, burns, and loose or broken stitching.</p> <p>12. Suspension Lines. Inspect for loose or broken stitching, broken lines, frays, burns, and tears.</p> <p>13. Slider. Check for legibility and completeness of marked data; dampness, foreign material, rips, burns, cuts, breaks, frays, tears, holes, and loose or broken stitching on fabric.</p> <p>14. Slider Grommets. Inspect for sharp edges, rust, burrs, rough spots, corrosion, cracks, foreign material, proper seating.</p> <p>15. Connector Links. Inspect for sharp edges, burrs, rough spots, corrosion, cracks and bends. Ensure barrel nut is secure.</p>	<p>Presence of loose or broken stitching, rips, snags, and burns.</p> <p>Presence of cuts, breaks, frays, burns, and loose or broken stitching.</p> <p>Presence of loose or broken stitching, broken lines, frays, burns, and tears.</p> <p>Presence of dampness, fungus, foreign material, rips, burns, cuts, breaks, frays, tears, holes, and loose or broken stitching on fabric.</p> <p>Presence of sharp edges, rust, burrs, rough spots, corrosion, cracks, foreign material; Grommets properly seated.</p> <p>Presence of sharp edges, burrs, rough spots, corrosion, cracks, and bends. Barrel nut is not secure.</p>
8	Before After	Harness Assembly	<p>1. All Webbing and Bindings. Inspect for loose or broken stitching, burns, frays, tears, and markings that are marred or illegible. Inspect for foreign materials.</p> <p>2. All Hardware and Functional Fittings. Inspect for improper operation, rust, corrosion, burrs, and cracks</p> <p>3. Retainer Webbing. Inspect for loose or broken stitching, loss of elasticity, cuts and frays.</p> <p>4. Canopy Release Assembly. Inspect for corrosion, rough spots, foreign material, bends, and cracks. Check for frays in cable loop. Check for proper function and operation with male fitting on harness.</p> <p>5. Canopy Release and Ejector Snap Pads. Inspect for loose or broken stitching and hand tacking, cuts, and tears.</p>	<p>Presence of loose or broken stitching, burns, frays, tears, marred or illegible markings or presence of foreign material.</p> <p>Presence of improper operation, rust, corrosion, burrs, and cracks</p> <p>Presence of loose or broken stitching, loss of elasticity, cuts and frays.</p> <p>Presence of corrosion, rough spots, bends, foreign material, cracks. Any frays in cable loops.</p> <p>Presence of loose or broken stitching and hand tacking, cuts, and tears.</p>

GENERAL - CONTINUED

Table 1. Preventive Maintenance Checks and Services for T-11 Personnel Parachute System-Continued.

ITEM NO.	INTERVAL	ITEM TO BE CHECKED OR SERVICED	PROCEDURE	EQUIPMENT NOT READY/ AVAILABLE IF:
	Before After	Harness Assembly - Continued	<p>6. Diagonal Backstrap. Inspect for loose or broken stitching, burns, frays, tears, and markings that are marred or illegible.</p> <p>7. Saddle Assembly. Inspect for loose or broken stitching, burns, frays, tears, and markings that are marred or illegible.</p> <p>8. Shoulder Pad. Inspect for loose or broken stitching, burns, frays, tears, and markings that are marred or illegible.</p> <p>9. Main Lift Web and Tuck Tab Assemblies. Inspect for loose or broken stitching, burns, frays, tears, and missing (or damaged) snap fasteners.</p>	<p>Presence of loose or broken stitching, burns, frays, tears, and marred or illegible markings.</p> <p>Presence of loose or broken stitching, burns, frays, tears, and marred or illegible markings.</p> <p>Presence of loose or broken stitching, burns, frays, tears, and marred or illegible markings.</p> <p>Presence of loose or broken stitching, burns, frays, tears, and missing (or damaged) snap fasteners.</p>
9	Before After	Main Pack Tray	<p>1. Pack Tray. Inspect for markings that are illegible. Inspect webbings, bindings, and cloth for loose or broken stitching and tacking, holes, tears, burns, and frays.</p> <p>2. Back Strap Retainers and Keepers. Inspect for loose or broken stitching, burns, frays, tears, and missing (or damaged) snap fasteners.</p> <p>3. Large Fabric Loop. Inspect for loose or broken stitching, burns, frays, tears, and markings that are marred or illegible. Ensure that tab is FG504 color.</p> <p>4. Inner and Outer Static Line Stow Bars with Retainer Bands. Inspect for loose or broken stitches, burns, frays and tears, presence of retainer bands.</p> <p>5. Static Line Slack Retainer. Inspect for loose or broken stitches, burns, frays, and tears.</p> <p>6. Waistband and Waistband Adjuster Panel. Inspect for loose or broken stitches, burns, frays and tears; and check metal adjuster for rust, burrs or corrosion.</p>	<p>Presence of illegible markings, loose or broken stitching and tacking, holes greater than 1-inch in diameter, tears, burns, and frays.</p> <p>Presence of loose or broken stitching, burns, frays, tears, and missing (or damaged) snap fasteners.</p> <p>Presence of loose or broken stitching, burns, frays, tears, and marred or illegible markings. Tab is not FG504.</p> <p>Presence of loose or broken stitches, burns, frays and tears. Retainer bands missing.</p> <p>Presence of loose or broken stitches, burns, frays, or tears.</p> <p>Presence of loose or broken stitches, burns, frays and tears; and checks metal adjuster for rust, burrs or corrosion.</p>

GENERAL - CONTINUED

Table 1. Preventive Maintenance Checks and Services for T-11 Personnel Parachute System-Continued.

ITEM NO.	INTERVAL	ITEM TO BE CHECKED OR SERVICED	PROCEDURE	EQUIPMENT NOT READY/ AVAILABLE IF:
	Before After	Main Pack Tray - Continued	7. Stiffener and Grommets. Inspect for loose, cracked or broken stiffener. Ensure grommet is seated and check for burrs, rough spots, corrosion, cracks, and bends and do not spin.	Presence of loose, cracked or broken stiffener. Presence of burrs, rough spots, corrosion, cracks, bends, or grommets spin.
10	Before After	T-11 Reserve Canopy	<p>1. Extractor. Inspect extractor, extractor lines, centering lines, and apex bridle lines for holes, cuts, frays, tears, burns, and loose or broken stitching. Check for placed in service date.</p> <p>2. Upper Lateral Band. Inspect for rips, burns, holes, tears, dampness, debris, frays, broken or loose stitching, and marred and illegible marks. Ensure 16 attaching loops are white and 4 extractor assemblies are FG504 or OD green.</p> <p>3. Extractor Bridle Lines. Ensure they are properly tied with surgeon's knot locking knot and trimmed to 1-inch and attached to 3, 8, 13, and 18 (colored tabs)</p> <p>4. Canopy Scoop. Inspect for loose or broken stitching, frays, tears, burns, and cuts.</p> <p>5. Scoop Tie Loops. Inspect for loose or broken stitching, frays, tears, burns, and cuts. Inspect for the presence of 8 loops.</p> <p>6. Canopy Gores. Starting at lower lateral band on gore 1, inspect for loose or broken stitching, frays, tears, burns, and cuts.</p> <p>7. Suspension Line Attaching Loop. Inspect for cuts, breaks, frays, burns, improper installation, and loose or broken stitching.</p> <p>8. Main Seams. Inspect for loose and broken stitching, holes and tears.</p> <p>9. Information Data Block. Inspect for legibility of data.</p>	<p>Presence of holes, cuts, frays, tears, burns, loose or broken stitching. Placed in service date missing.</p> <p>Presence of rips, burns, holes, tears, dampness, debris, frays, broken or loose stitching, and marred and illegible marks. Missing white attachment loops or FG504 or OD green extractor assemblies</p> <p>Not properly tied or trimmed. Not attached properly.</p> <p>Presence of loose or broken stitching, frays, tears, burns, and cuts.</p> <p>Presence of loose or broken stitching, frays, tears, burns, and cuts. Loops are missing.</p> <p>Presence of loose or broken stitching, frays, tears, burns, and cuts.</p> <p>Presence of cuts, breaks, frays, burns, improper installation, and loose or broken stitching.</p> <p>Presence of loose and broken stitching, holes and tears.</p> <p>Data illegible.</p>

GENERAL - CONTINUED

Table 1. Preventive Maintenance Checks and Services for T-11 Personnel Parachute System-Continued.

ITEM NO.	INTERVAL	ITEM TO BE CHECKED OR SERVICED	PROCEDURE	EQUIPMENT NOT READY/ AVAILABLE IF:
	Before After	T-11 Reserve Canopy - Continued	<p>10. Skirt Assist Ties. Inspect for burns, cuts, breaks, loose or broken stitching. Check for presence of skirt assist ties.</p> <p>11. Suspension Lines. Inspect for loose or broken stitching, broken lines, broken core cords, frays, burns, and tears.</p> <p>12. Connector Link. Inspect for burrs, roughness, corrosion, cracks or bends.</p>	<p>Presence of burns, cuts, breaks, and loose or broken stitching. Skirt assist ties missing.</p> <p>Presence of loose or broken stitching, broken lines, broken core cords, frays, burns, and tears.</p> <p>Presence of burrs, rough spots, corrosion, cracks and bends.</p>
11	Before After	Main Risers	<p>1. Guide Channel. Inspect for burns, cuts, breaks, and loose or broken stitching.</p> <p>2. Risers. Inspect for missing, loose or broken stitching and tacking, burns, frays, tears, deterioration, and marred (or illegible) markings. Inspect for presence of 4-point W stitch formation.</p> <p>3. Canopy Release Male Fittings. Inspect for corrosion, rough spots, bends, and cracks.</p> <p>4. Log Record Stow Pocket. Inspect for loose or broken stitching. Presence of directional snap fastener.</p> <p>5. Identification. Inspect for loose or missing blue confluence wrap.</p> <p>6. Guide ring. Inspect for burrs, roughness, corrosion, cracks or bends.</p>	<p>Presence of burns, cuts, breaks, and loose or broken stitching.</p> <p>Presence of loose or broken stitching and tacking, burns, frays, tears, deterioration, and marred (or illegible) markings. 4-point W stitch formation is missing.</p> <p>Presence of corrosion, rough spots, bends, cracks.</p> <p>Presence of loose or broken stitching. Directional snap fastener missing.</p> <p>Blue confluence wrap loose or missing.</p> <p>Presence of burrs, rough spots, corrosion, cracks and bends.</p>
12	Before After Before After	Harness Harness - Continued	<p>1. All Hardware & Functional Fittings. Inspect for improper operation, rust, corrosion, burrs, & cracks.</p> <p>2. All Webbing, Bindings, and Cloth. Inspect for loose or broken stitching, burns, frays, tears, and markings that are marred or illegible.</p> <p>3. Retainer Webbing. Inspect for loose or broken stitching, loss of elasticity, cuts and frays.</p> <p>4. Canopy Release and Ejector Snap Pads. Inspect for loose or broken stitching and hand tacking, cuts, and</p>	<p>Presence of improper operation, rust, corrosion, burrs, & cracks.</p> <p>Presence of loose or broken stitching, burns, frays, tears, and marred or illegible markings.</p> <p>Presence of loose or broken stitching, loss of elasticity, cuts and frays.</p> <p>Presence of loose or broken stitching and hand tacking, cuts, and tears.</p>

GENERAL - CONTINUED

Table 1. Preventive Maintenance Checks and Services for T-11 Personnel Parachute System-Continued.

ITEM NO.	INTERVAL	ITEM TO BE CHECKED OR SERVICED	PROCEDURE	EQUIPMENT NOT READY/ AVAILABLE IF:
			tears. 5. Canopy Release Assembly. Inspect for corrosion, rough spots, foreign material, bends, and cracks. 6. Horizontal Back Strap. Inspect for loose or broken stitching, burns, frays, tears, and marred (or illegible) markings. 7. Hip Pad. Inspect for loose or broken stitching, burns, frays, tears, and markings that are marred or illegible. 8. Saddle Assembly. Inspect for loose or broken stitching, burns, frays, tears, and markings that are marred or illegible. 9. Shoulder Pad. Inspect for loose or broken stitching, burns, frays, tears, and markings that are marred or illegible.	Presence of corrosion, rough spots, bends, foreign material, cracks. Presence of loose or broken stitching, burns, frays, tears, and marred (or illegible) markings. Presence of loose or broken stitching, burns, frays, tears, and marred or illegible markings. Presence of loose or broken stitching, burns, frays, tears, and marred or illegible markings. Presence of loose or broken stitching, burns, frays, tears, and marred or illegible markings.
13	Before After	Reserve Riser	1. Webbing. Inspect for loose or broken stitching, holes, line extension tears, burns or frays. 2. Fastener Tape, Hook and Pile. Inspect for loose or broken stitching, holes, tears, burns or frays. 3. Connector Snap. Inspect for burrs, rough spots, corrosion, cracks and bends. Ensure connector snap is secured to packing with lacing tying tape. Operate snap hook to ensure smooth operation. 4. Spreader Bar. Inspect for loose or broken stitching, holes, tears, burns or frays	Presence of loose or broken stitching, holes, line extension tears, burns or frays. Presence of loose or broken stitching, holes, tears, burns or frays. Presence of burrs, rough spots, corrosion, cracks and bends. Presence of loose or broken stitching, holes, tears, burns or frays.
14	Before After	Reserve Pack Tray	1. Stiffener and Grommets. Inspect for loose, cracked or broken stiffener. Ensure grommet is seated and check for burrs, rough spots, corrosion, cracks, and bends and do not spin. 2. Retainer Band Keepers. Inspect for loose or broken stitches, burns, frays and tears.	Presence of loose, cracked or broken stiffener. Presence of burrs, rough spots, corrosion, cracks, bends or loose grommets. Presence of loose or broken stitches, burns, frays and tears.

GENERAL - CONTINUED

Table 1. Preventive Maintenance Checks and Services for T-11 Personnel Parachute System-Continued.

ITEM NO.	INTERVAL	ITEM TO BE CHECKED OR SERVICED	PROCEDURE	EQUIPMENT NOT READY/ AVAILABLE IF:
			<p>3. Log Record Pocket. Inspect for loose or broken stitching</p> <p>4. Pack Tray. Inspect for illegible markings. Inspect webbings, bindings, and duck cloth for loose or broken stitching and tacking, holes, tears, burns, and frays.</p> <p>5. Edge Binding. Inspect for loose or broken stitches, burns, frays and tears.</p> <p>6. Stow Bars. Inspect for loose or broken stitches, burns, frays and tears.</p> <p>7. Waistband Retainer. Inspect for loose or broken stitches, burns, frays and tears.</p> <p>8. Ripcord Assembly. Inspect for loose or broken stitches, burns, frays and tears. Inspect for presence of red handle, curved pin, and directional arrow. Inspect curved pin lanyard. Ensure stiffener is present and not cracked.</p> <p>9. Protection Cap. Inspect the reserve protection cap for damage; there should be no holes or tears in the protection cap. Ensure the binding tape on the outer edge of the protection cap is not torn and no stitching missing.</p> <p>10. Ejector Spring. Inspect for loose or broken stitching, frays, tears, burns, and cuts. Inspect for rust, burrs, rough spots, corrosion, cracks, distorted or broken springs</p> <p>11. Reserve Closing Loop. Inspect for burns, cuts, breaks, loose or broken stitching.</p>	<p>Presence of loose or broken stitching</p> <p>Presence of illegible markings, loose or broken stitching and tacking, holes, tears, burns, and frays.</p> <p>Presence of loose or broken stitches, burns, frays and tears.</p> <p>Presence of loose or broken stitches, burns, frays and tears.</p> <p>Presence of loose or broken stitches, burns, frays and tears.</p> <p>Presence of loose or broken stitches, burns, frays and tears. Red handle, curved pin, or directional arrow missing. Curved pin lanyard damaged. Stiffener missing or cracked.</p> <p>Presence of damage; holes or tears in the protection cap. Protection cap outer edge binding tape is torn or has missing stitching.</p> <p>Presence of loose or broken stitching, frays, tears, burns, and cuts. Presence of rust, burrs, rough spots, corrosion, cracks, distorted or broken springs.</p> <p>Presence of burns, cuts, breaks, loose or broken stitching</p>

MANDATORY REPLACEMENT PARTS

There are no mandatory replacement parts required for these PMCS procedures.

END OF WORK PACKAGE

CHAPTER 3

FIELD MAINTENANCE INSTRUCTIONS
FOR
T-11 PERSONNEL PARACHUTE SYSTEM

FIELD MAINTENANCE
SERVICE UPON RECEIPT

INITIAL SETUP:**Equipment Condition**

All equipment shall be serviceable and ready for use.

Personnel Required

92R1P Parachute Rigger

References

DA PAM 738-751
DA PAM 750-8
SF 361
WP 0009
WP 0010
WP 0100

SERVICE UPON RECEIPT**General Procedures for Air Delivery Equipment**

When air delivery equipment is initially procured from a supply source and issued to a using unit, the item(s) will be unpacked from the shipping container(s) and inspected by a qualified parachute rigger (MOS 92R). The inspection performed will be a technical/rigger-type inspection and will be conducted as outlined in the Preventive Maintenance Checks and Services (PMCS) procedures. Upon completion of the inspection, the item(s) will be tagged as prescribed in DA PAM 738-751. Serviceable equipment may then be entered either into storage or into use in airdrop operations, as applicable. An unserviceable item will be held and reported, in accordance with DA PAM 750-8.

Inspection Personnel

Personnel other than parachute rigger personnel may assist in the unpacking process of initially received parachutes, as directed by the local Airdrop Systems Technician (921A) or Senior Airdrop NCO (92R4P) and above, under guidance from an Airdrop Systems Technician assigned to the command at the Battalion level or higher, when no Airdrop Technician is assigned at the Company/Detachment/Team level. However, the Airdrop Systems Technician will ensure the entire unpacking effort is conducted under the direct supervision of a qualified rigger (MOS 92R).

Configuration Condition

Acceptance of new equipment from the manufacturer is based upon inspections made of sample lots that have been randomly selected in accordance with military standards. It is incumbent upon the using activity personnel to bear this in mind whenever equipment is first placed in service. Changes will sometimes evolve from the original equipment design and sometimes contractors are authorized deviations in material and construction techniques. Air delivery equipment that has been in the field cannot be expected to meet exacting manufacturing specifications; however, the equipment should closely reflect desired design characteristics. Since repairs, modifications, and/or changes can alter or detract from the configuration originally desired; such equipment shall be airworthy, safe, of the desired configuration, and adequate for intended use.

SERVICE UPON RECEIPT-CONTINUED**Receipt of Used Parachute**

Upon initial receipt of used parachute, proceed as follows:

1. Follow procedures given in the General Procedures for Air Delivery Equipment paragraph, above, and check each component for excessive wear and tear.
2. If defects or damages are discovered, process the parachute for maintenance at the maintenance level assigned by the Maintenance Allocation Chart (MAC), WP 0100.

END OF TASK**After-Use Receipt**

When a parachute is received at the maintenance activity, following its use by the parachutist during air delivery, it must be given a shakeout and aired (WP 0009), and if necessary, cleaned (WP 0010) before it can be returned to service. If a parachute is issued but is not used, it does not need to be given a shakeout; however, it must be given a routine inspection by a qualified parachute rigger (MOS 92R).

Checking Unpacked Equipment after Shipment

1. Inspect equipment for damage incurred during shipment. If the equipment has been damaged, report the damage on a SF 361, Transportation Discrepancy Report (TDR).
2. Check the equipment against the packing slip to see if the shipment is complete. Report all discrepancies in accordance with the instructions in DA PAM 750-8.
3. Check to see whether the equipment has been modified.

END OF TASK**END OF WORK PACKAGE**

FIELD MAINTENANCE

**MAIN CANOPY
ASSEMBLY**

INITIAL SETUP:

Tools and Special Tools

Adapter, Tension Plate (WP 0102, Item 1)
 Brush, Stenciling (WP 0102, Item 6)
 Crowfoot Attachment, Socket Wrench, 3/8-inch Drive,
 Open End, 7/16-inch (WP 0102, Item 11)
 Knife, Pocket (WP 0102, Item 24)
 Needle, Upholsterer's, Curved, Size 3 (WP 0102,
 Item 29)
 Needle, Upholsterer's, Curved, Size 5 (WP 0102,
 Item 30)
 Packing Loop, Tension Device (WP 0102, Item 31)
 Plate, Tension, Parachute Packing (WP 0102, Item 36)
 Quick Release, Hook and Lanyard (WP 0102, Item 44)
 Sleeve Organizer, Deployment, T-11 Main (WP 0102,
 Item 61)
 Stencil Cutting Machine, Hand Operated (WP 0102,
 Item 62)
 Wrench, Torque, 0-300-inch pounds (WP 0102, Item 71)

Personnel Required

Parachute Rigger 92R1P (2)

References

WP 0001
 WP 0006
 WP 0018

Materials/Parts

Band, Rubber, Parachute, 1-¼-inch, 3/8-inch Wide
 (WP 0101, Item 2)
 Band, Rubber, Parachute, 2-inch Long, 3/8-inch Wide
 (WP 0101, Item 3)
 Book, Log Record (WP 0101, Item 5)
 Ink, Parachute Marking, Light Blue, A-A-59291
 (WP 0101, Item 27)
 Pen, Ball Point (WP 0101, Item 30)
 Stencil Board, Oiled (WP 0101, Item 38)
 Tape, Lacing and Tying, Nylon, (WP 0101, Item 42)

Equipment Condition

Unpacked

ASSEMBLY

Assembly procedures begin on the next page.

ASSEMBLY – CONTINUED

WARNING



Assembly of the main canopy shall be completed in accordance with the following procedures. Failure to do so may result in serious injury or death to the parachutist.

NOTE

If any component is found to be unserviceable when it is received from the supply activity, the component should be set aside and a PQDR should be submitted prior to initiating any repairs on that component.

T-11 Component Inventory Check





Before proceeding with the assembly of the T-11 parachute system, ensure that all components as detailed in Table 1 are present and have been inspected IAW WP 0006 entitled Service Upon Receipt.

Table 1. T-11 Personnel Parachute System Major Components.

Part Number	Official Item Name (Common Item Name)	Qty/ EI	Unit of Issue	Photo
11-1-7051-1	T-11 Main Parachute Assembly (Main Canopy)	1	EA	
11-1-6993-3	Static Line, Modified, Personnel (Universal Static Line Modified [With Curved Pin])	1	EA	
11-1-6993-2	Static Line, Extension, Personnel Parachute (USL 5-Foot Extension)	1	EA	



ASSEMBLY – CONTINUED

Table 1. T-11 Personnel Parachute System Major Components - Continued.

Part Number	Official Item Name (Common Item Name)	Qty/ EI	Unit of Issue	Photo
11-1-7062-1	T-11 Main Bridle Assembly with Connector Link (Bridle Assembly with Connector Link)	1	EA	
11-1-6991-1	Static Line Snap Hook (USL Snap Hook)	1	EA	
11-1-7722-1	T-11 Harness Assembly (Harness)	1	EA	
11-1-7063-1	T-11 Main Deployment Bag Assembly (Deployment Bag)	1	EA	
11-1-7720 -1	T-11 Main Pack Tray (Main Pack Tray)	1	EA	





ASSEMBLY – CONTINUED

Table 1. T-11 Personnel Parachute System Major Components - Continued.

Part Number	Official Item Name (Common Item Name)	Qty/ EI	Unit of Issue	Photo
11-1-7719-1	T-11 Main Riser Set (Main Riser Assembly)	1	EA	
11-1-7061-1	Deployment Sleeve Assembly (Deployment Sleeve)	1	EA	
11-1-7060-1	T-11 Main Drogue Assembly (Drogue Parachute)	1	EA	



ASSEMBLY – CONTINUED

Table 1. T-11 Personnel Parachute System Major Components - Continued.

Part Number	Official Item Name (Common Item Name)	Qty/ EI	Unit of Issue	Photo
11-1-7052-1	T-11R Canopy Assembly (Reserve Canopy)	1	EA	
11-1-7726-1	T-11R Reserve Pack Tray Assembly (Reserve Pack Tray)	1	EA	
11-1-7058-1	T-11R Reserve Ripcord Assembly (Reserve Ripcord)	1	EA	
11-1-7065-1	T-11R Ejector Spring Assembly (Ejector Spring)	1	EA	

ASSEMBLY – CONTINUED

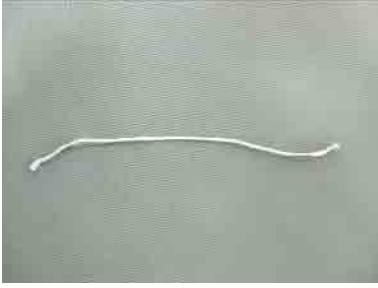
Table 1. T-11 Personnel Parachute System Major Components - Continued.

Part Number	Official Item Name (Common Item Name)	Qty/ EI	Unit of Issue	Photo
11-1-7064-1	T-11R Extractor Assembly (Reserve Extractor)	1	EA	
11-1-7067-1	T-11R Closing Loop Assembly (Reserve Closing Loop)	1	EA	
11-1-7069-1	T-11R Protection Cap Assembly (Protection Cap)	1	EA	
11-1-7729-1	T-11R Riser Set (Reserve Risers)	1	EA	

END OF TASK

ASSEMBLY – CONTINUED**Marking Parachute Canopy**

Prior to being placed into service, personnel parachutes that have had no previous use will be marked to reflect the date of entry into service. The marking will be made on the canopy information data block by stenciling the lettering in ½-inch characters using the marking and re-stenciling repair procedures detailed in WP 0018. Other applicable parachute components will be marked adjacent to existing data.

The stenciled data will appear as "Placed In Service (PIS)" followed by the date, which will indicate the month and calendar year, such as "JAN 05." Ensure the added marking does not infringe upon, or obliterate, any original data on the information data block.

Marking Parachute Components

Main parachute components will be placed in service by placing the in-service date on the following components. Refer to WP 0001 for data block and label locations.

- In-service date will be entered on the data panel on each riser.
- Stencil the drogue parachute in-service date near the data block.
- Stencil the slider in-service date below data block and number one grommet.
- Stencil the deployment sleeve in-service date below the data block.
- Harness assembly in-service date will be entered on the data panel on the lower saddle.

Place Components in Proper Layout

Place the components on a packing table and obtain proper layout of the canopy as follows:

1. Place the main canopy and all components on the packing table.
2. Lay out the main canopy on the packing table with the connector links at the lower end of the table.
3. Extend the canopy along the length of the table with the connector links at the lower end of the packing table.
4. Secure the bridle ring at the top of the main canopy to the quick release hook.
5. Split the canopy between the left and right suspension line groups at the lower lateral band.

ASSEMBLY – CONTINUED**NOTE**

Use line organizing card if applicable.

6. Completely open the barrel nut (Figure 1, Item 6) on the connector links and remove connector links from line organizing card (Figure 1, Item 7). Once connector links are removed from organizing card, loosely close barrel nuts.

WARNING

Connector link barrel nuts must be oriented so they face inboard and tighten downward. Failure to do so may result in serious injury or death to the parachutist.

NOTE

Suspension lines 1 through 28 are divided into two groups, number 1 through 14 in the right group and number 15 through 28 in the left group.

7. Elongate both left and right suspension line groups and place the left set of connector links on the left post (Figure 1, Item 8) of the tension plate adapter (Figure 1, Item 9) and the right set of connector links on the right post (Figure 1, Item 10) of the tension plate adapter with barrel nuts oriented inward so they tighten downward.

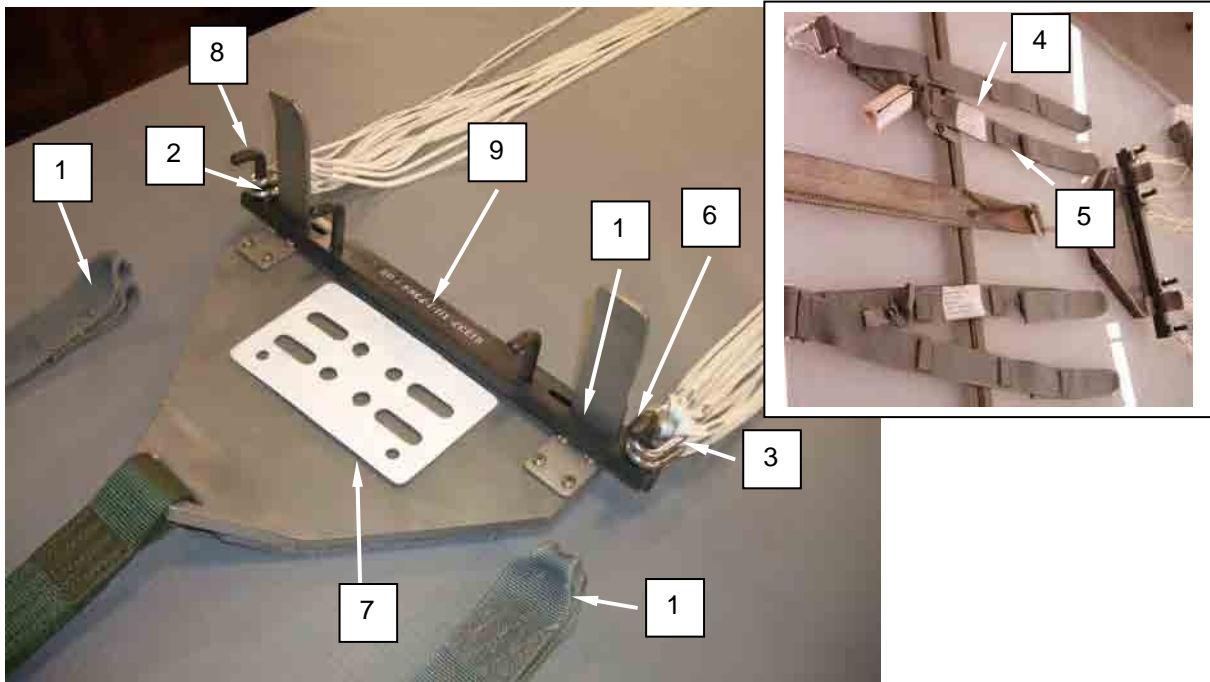

Figure 1. Place Connector Links and Riser Assembly.

END OF TASK

ASSEMBLY – CONTINUED**Attach the Main Risers to the Main Canopy****CAUTION**

Do not use vise grips or other type pliers to hold connector link body when tightening, as damage to connector link can occur.

1. Lay out the main risers (Figure 2, Item 1) directly behind the left (Figure 2, Item 2) and right (Figure 2, Item 3) connector link groups ensuring that there are no twists. Ensure that label (Figure 2, Item 4) is facing up and slip assist tabs (Figure 2, Item 5) are facing up.

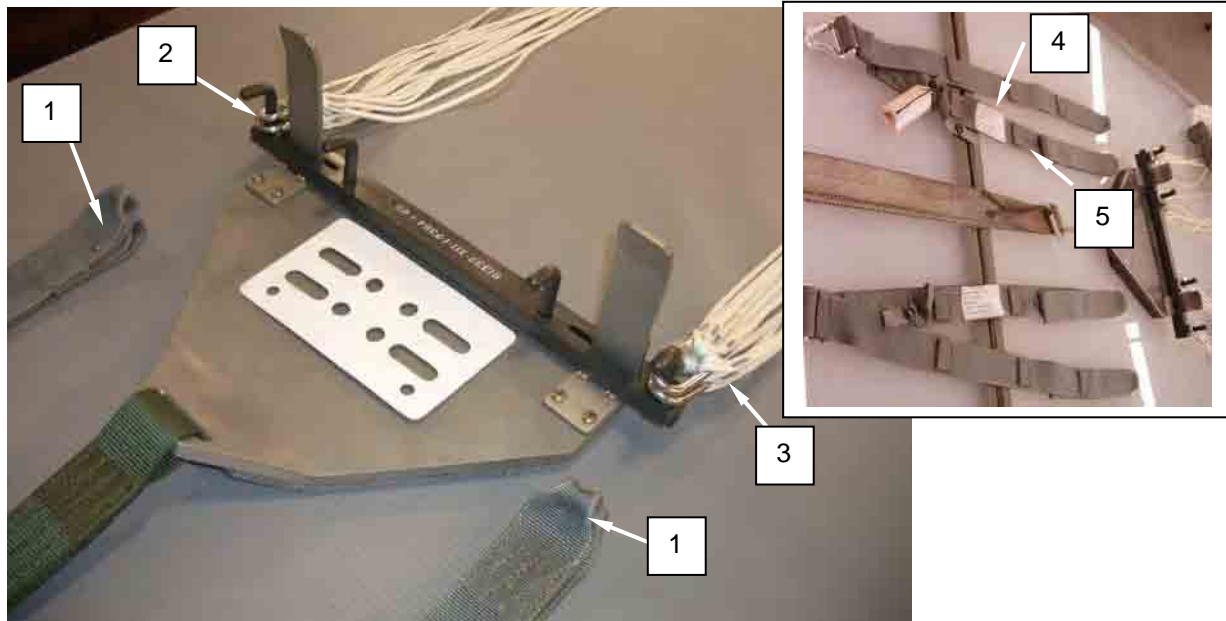

Figure 2. Lay Out Riser Assembly.

2. Attach the appropriate riser (Figure 3, Item 1) to the appropriate connector link (Figure 3, Item 2) (top left connector link to the top left riser, etc). Do not tighten barrel nuts at this time.



Figure 3. Attaching Risers to Connector Links.

END OF TASK

ASSEMBLY – CONTINUED**Perform a 100% Line Continuity Check****NOTE**

Two personnel are required for a line continuity check. The first person will be at the connector links to ensure slider is not twisted, that lines are going through properly numbered grommets, and are located on connector links properly. The second person will be at the lower lateral band to identify the proper numbered suspension lines.

1. Conduct a continuity check in accordance with the illustration below paying close attention to the suspension lines routed through the slider (Figure 4).
2. Top right suspension line group. Line 1 (inside top) followed in sequence by 2, 3, 4, 5, 6, 7 (outside top) runs from the canopy, through the same numbered slider grommets, to the top right connector link.
3. Bottom right suspension line group. Line 8 (outside bottom) followed in sequence by 9, 10, 11, 12, 13, 14 (inside bottom) runs from the canopy, through the same numbered slider grommets, to the bottom right connector link (Figure 4).
4. Bottom left suspension line group. Line 15 (inside bottom) followed in sequence by 16, 17, 18, 19, 20, 21 (outside bottom) runs from the canopy, through the same numbered slider grommets, to the bottom left connector link (Figure 4).
5. Top left suspension line group. Line 22 (outside top) followed in sequence by 23, 24, 25, 26, 27, 28 (inside top) runs from the canopy, through the same numbered slider grommets, to the top left connector link (Figure 4).

ASSEMBLY – CONTINUED

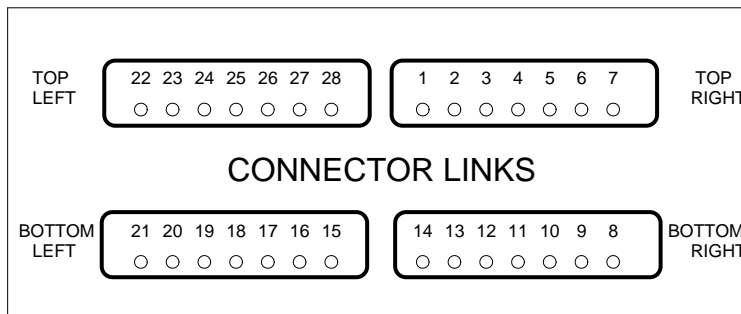
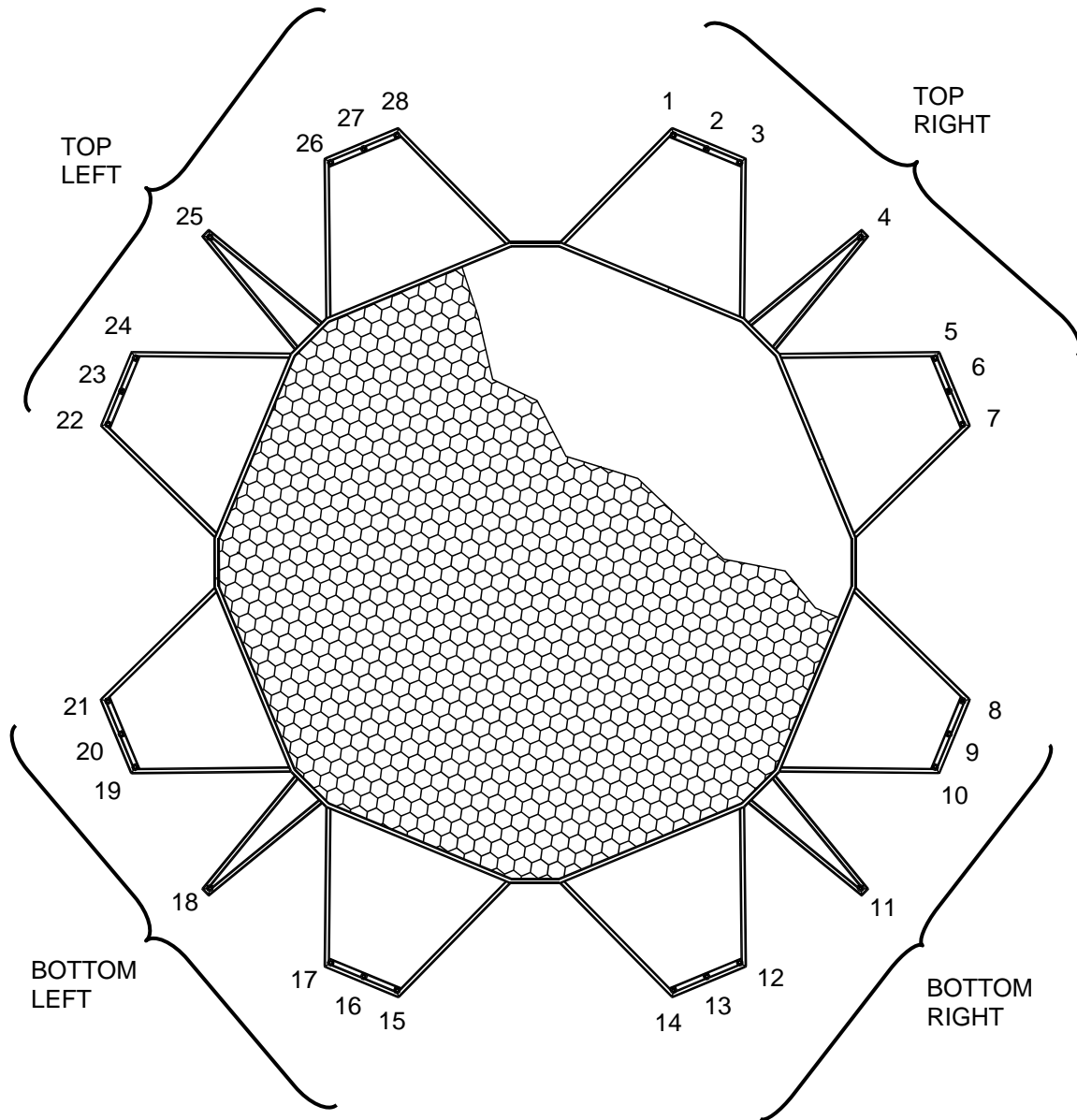

Figure 4. Main Canopy Slider and Suspension Line Location.

END OF TASK

ASSEMBLY – CONTINUED**Torque and Tack Main Risers****CAUTION**

Do not use vise grips or other type pliers to hold connector link body when tightening, as damage to connector link can occur.

NOTE

Ensure torque wrench is calibrated with TMDE prior to use.

1. Using torque wrench with crowfoot adapter set to 50 inch-pounds, tighten barrel nut (Figure 5, Item 1) on connector links (Figure 5, Item 2).



Figure 5. Tightening Connector Link Barrel Nut with Crowfoot Adapter.

ASSEMBLY – CONTINUED

2. Remove connector links and risers from the tension plate adapter. Rotate each riser sideways on the long portion of the connector links opposite the barrel nut.
3. Tack each riser (Figure 6, Item 3) with an 18-inch length of lacing and tying tape one turn double (Figure 6, Item 4). Pass the upholsterer's needle (Figure 6, Item 5) tight against the body (Figure 6, Item 6) of the connector link with knot toward top when tied.

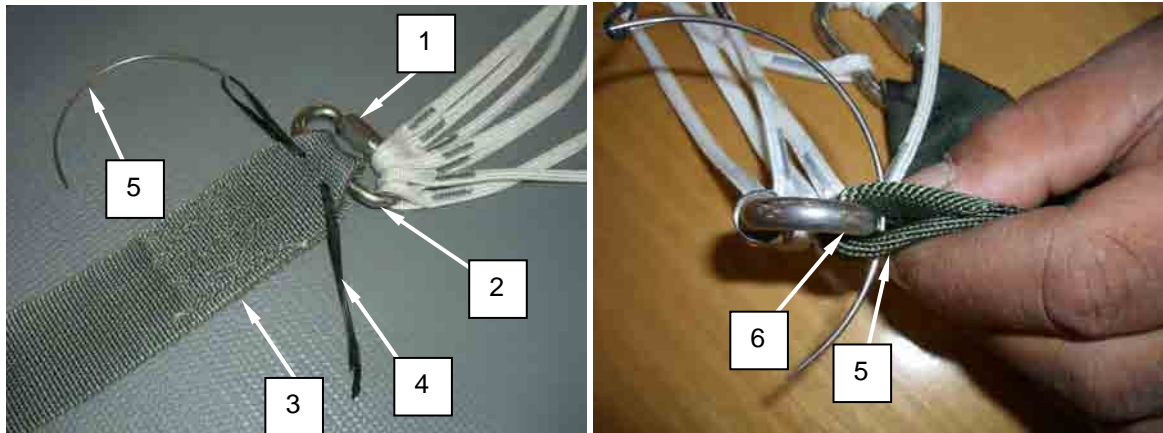

Figure 6. Tightening Connector Link Barrel Nut and Tacking Each Riser.

4. Secure lacing and tying tape with a surgeon's knot locking knot (Figure 7, Item 1), trimming the running ends to ½ inch.

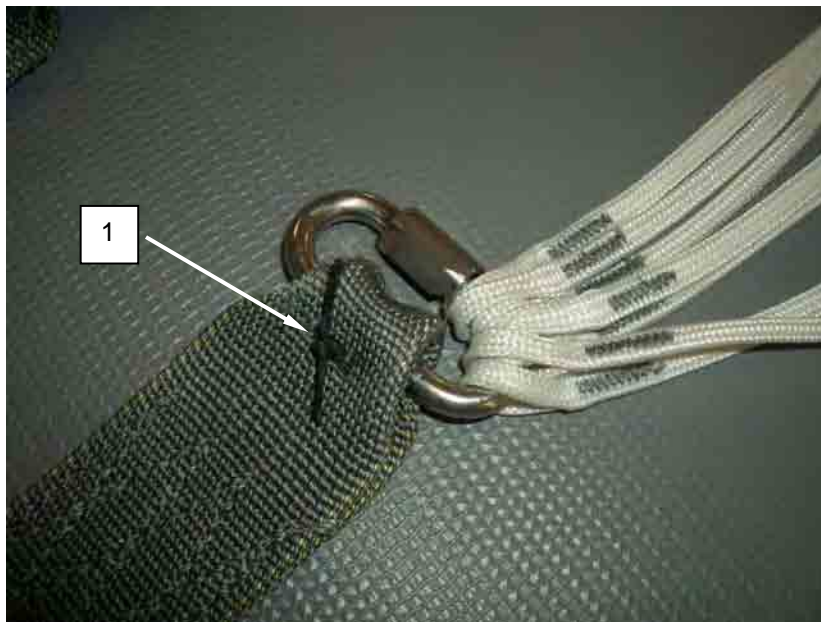

Figure 7. Securing Lacing and Tying Tape with Surgeon's Knot Locking Knot.

ASSEMBLY – CONTINUED

5. Rotate the riser (Figure 8, Item 1) to the lower portion of the connector link (Figure 8, Item 2). Ensure the barrel nut tightens toward the riser.
6. Reattach risers and connector links to tension plate adapter.

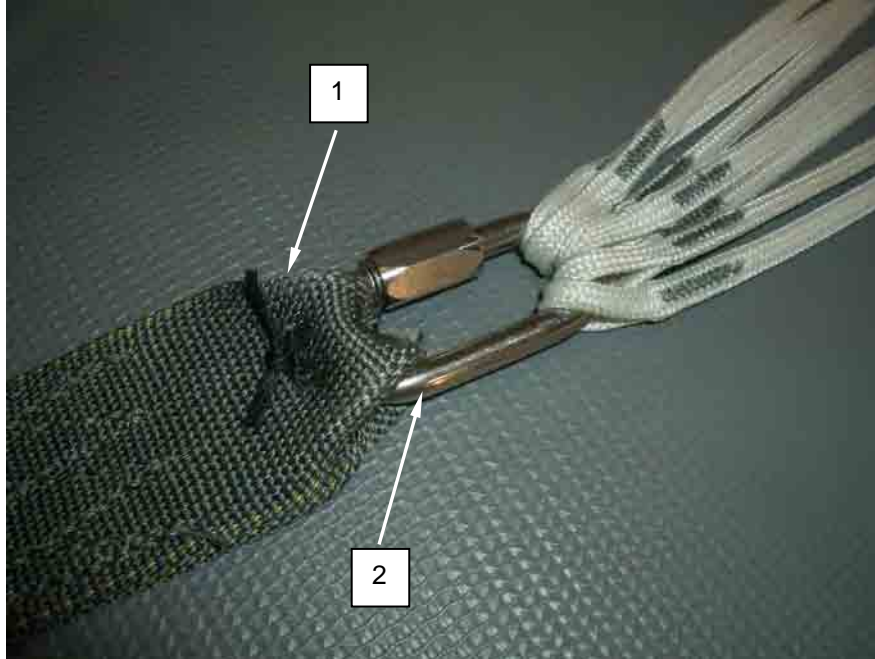

Figure 8. Positioning Riser to Lower Portion of Connector Link.

END OF TASK

ASSEMBLY – CONTINUED

Parachute Log Record

The Army Parachute Log Record, DA Form 3912, AFTO 391 is a history-type maintenance document that accompanies the parachute canopy through the period of service of the individual assembly. The log record provides a means of recording maintenance actions performed on a parachute canopy assembly. Normally, a log record is initiated and attached to a riser assembly upon receipt by a using unit. If the item is subjected to alteration or modification by a maintenance activity during the interim period from date of manufacture to receipt by a using unit, the log record will be prepared by the activity performing the maintenance function. Once initiated, a log record will be attached to, and contained in, an affixed parachute log record/inspection data pocket, until such time as the parachute canopy assembly is destroyed or rendered unfit for further use or repair.

Additionally, should an item that requires a log record, be transferred from one unit to another, the log record for the parachute assembly will accompany the item in the transfer action. A prepared log record will not be removed or separated from a parachute, and especially a packed parachute, except as directed by the local Airdrop Systems Technician (921A) or Senior Airdrop NCO (92R4P) and above, under guidance from an Airdrop Systems Technician assigned to the command at the Battalion level or higher, when no Airdrop Technician is assigned at the Company/Detachment/Team level.

A log record that is illegible, lost, damaged, soiled, or precludes further entries due to lack of space, will be replaced upon the next repack or inspection, as applicable, with a serviceable item from stock.

Installing Attaching Tie

1. Cut a 30-inch length of lacing and tying tape and double the lacing length.
2. Pass the looped end through the centerfold of the log record, pass the running end through the loop forming a slip loop on the outside, at the log record top (Figure 16).

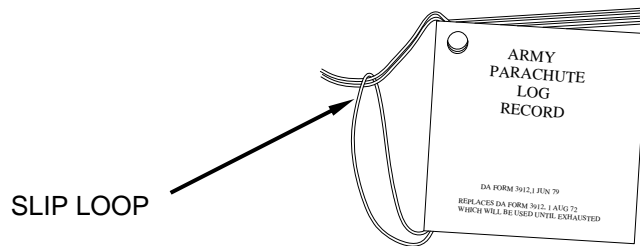

Figure 9. Forming Slip Loop on Log Record Outside.

3. Pass the lacing and tying tape length running ends through the corner attaching hole, from the front cover of the log record (Figure 10).

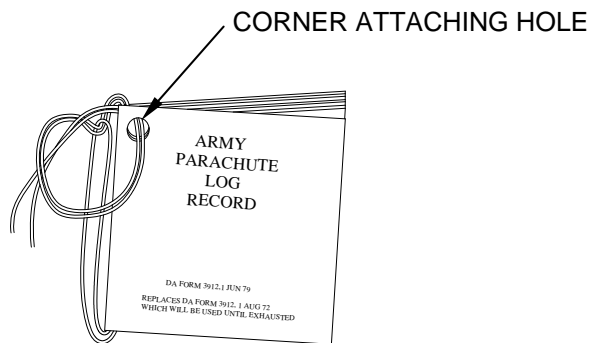

Figure 10. Pass Lacing and Tying Tape Loose Ends Through Corner Attaching Hole.

ASSEMBLY – CONTINUED

4. Ensure the running ends are routed over that part of the lacing and tying tape length located along the log record centerfold (Figure 11).

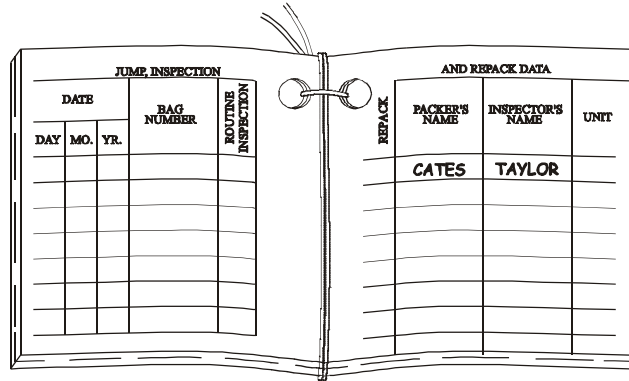

Figure 11. Routing Lacing and Tying Tape Running End Through Log Record Centerfold.

5. Complete the attachment tie by making a half hitch on top of the slip loop made in step 2. (Figure 12).
6. Thread one running end of the log record attachment tie in an upholsterer's needle and pass the needle, with attached tie, through the edge binding of the applicable parachute log record/inspection data pocket.
7. Remove the lacing and tying tape end from the upholsterer's needle and make a finished 10-inch long log record attaching loop by securing the two lacing ends together with an overhand knot. Trim running ends to 1-inch.

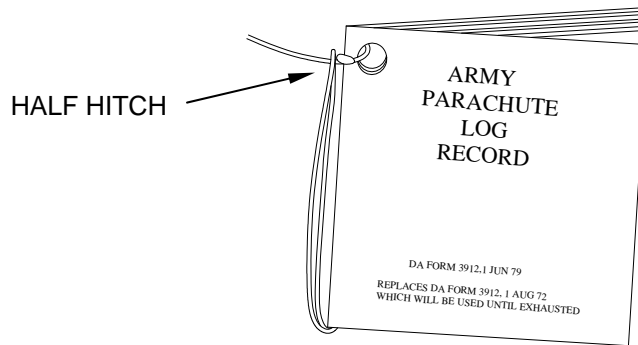

Figure 12. Log Record Attachment Tie Completed.

8. Insert the log record into the log record pocket and secure the record within the pocket using the pocket flap and applicable type flap fastener.

END OF TASK

ASSEMBLY – CONTINUED**Attaching the Harness Assembly to the Pack Tray**

1. Lay pack tray (Figure 13, Item 1) on pack table with the harness assembly attaching points (Figure 13, Item 2) facing up.
2. Place the new harness assembly (Figure 13, Item 3) on the pack tray with the hip (Figure 13, Item 4) and shoulder pads (Figure 13, Item 5) facing up. Ensure the diagonal back straps intersect (Figure 13, Item 6) in the center of the pack tray, and ensure there are no twists in the upper main lift web (Figure 13, Item 7), and lower saddle assembly (Figure 13, Item 8).

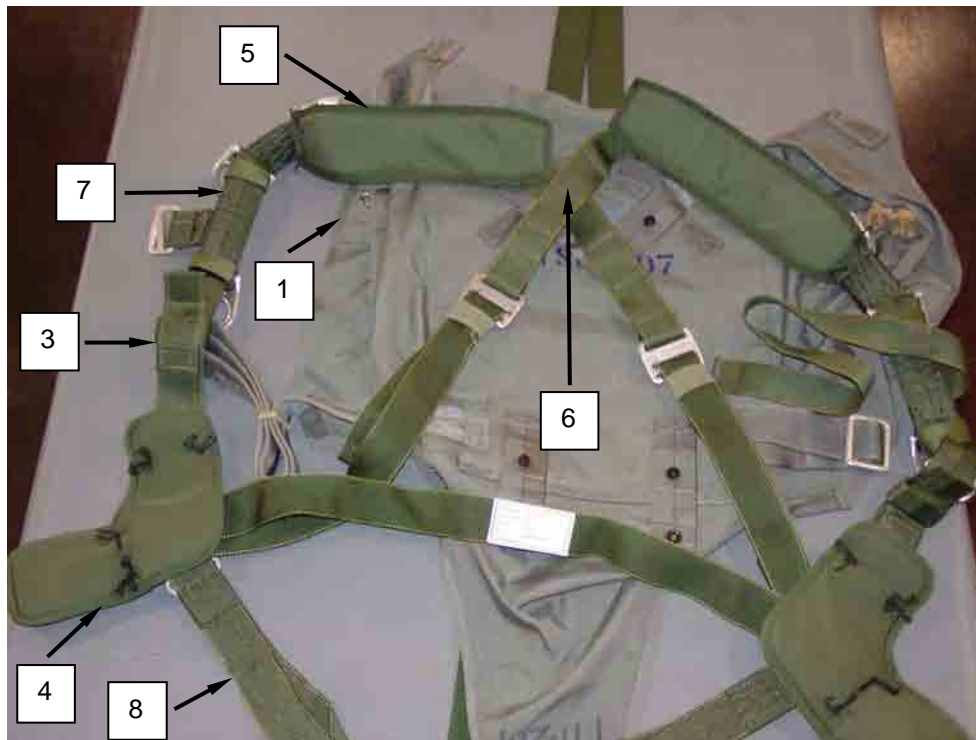
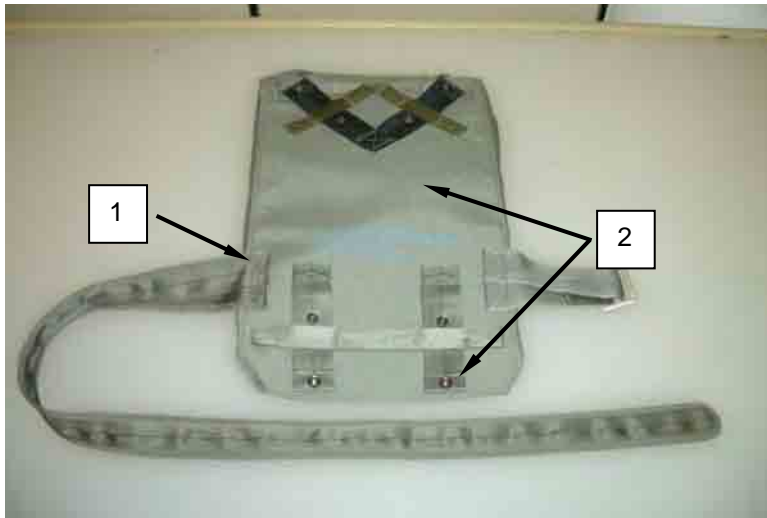

Figure 13. Pack Tray and Harness Assembly.

ASSEMBLY – CONTINUED

3. Secure the horizontal back strap (Figure 14, Item 1) by routing both pack tray horizontal back strap retainers (Figure 14, Item 2) over the horizontal back strap (Figure 14, Item 1), and under the horizontal back strap keepers and secure the directional snap fasteners (Figure 14, Item 3).



Figure 14. Securing Horizontal Back Strap.

ASSEMBLY – CONTINUED

4. Attach diagonal back straps (Figure 15, Item 1) by routing the diagonal backstrap retainer (Figure 15, Item 2) through the selected sizing channel (Figure 15, Item 3).
5. Route the diagonal backstrap retainer (Figure 15, Item 2) under the diagonal backstrap keeper (Figure 15, Item 4).
6. Close snap fastener (Figure 15, Item 5) to secure.
7. Repeat for the opposite side (Figure 15, Item 6); ensure that the same sizing channel is used for both.
8. Enter the date placed in service on the horizontal back strap in data panel, if using a new harness assembly.

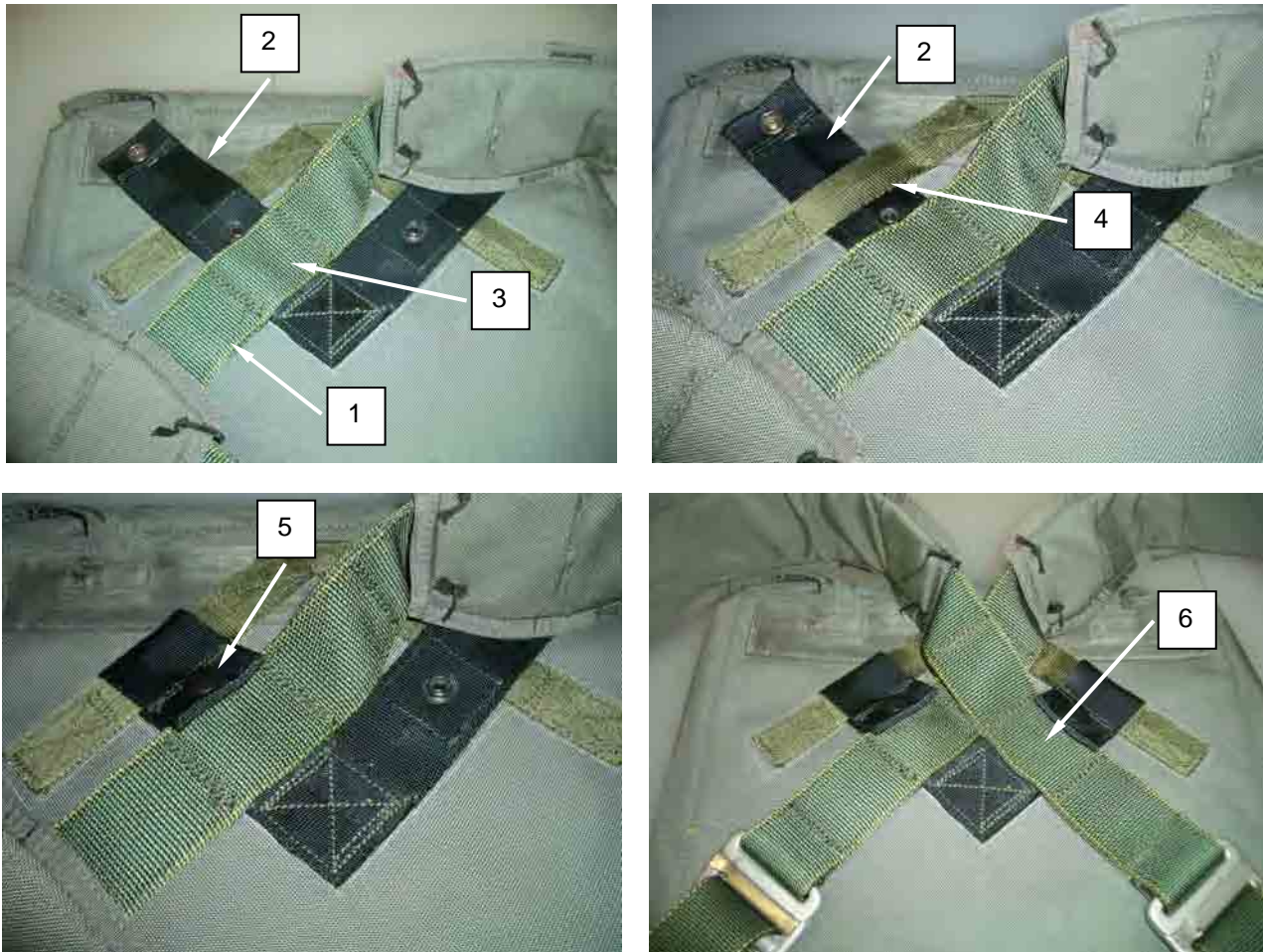

Figure 15. Securing Diagonal Backstraps.

END OF TASK

ASSEMBLY – CONTINUED**Attach Retainer Bands to Main Pack Tray**

Attach two 2-inch retainer bands (Figure 16, Item 1) on each outer static line stow bar (Figure 16, Item 2) and one 2-inch retainer band on each inner static line stow bar loop. Attach two, 1 ¼-inch retainer bands to the static line slack retainer (Figure 16, Item 3) of the pack tray.

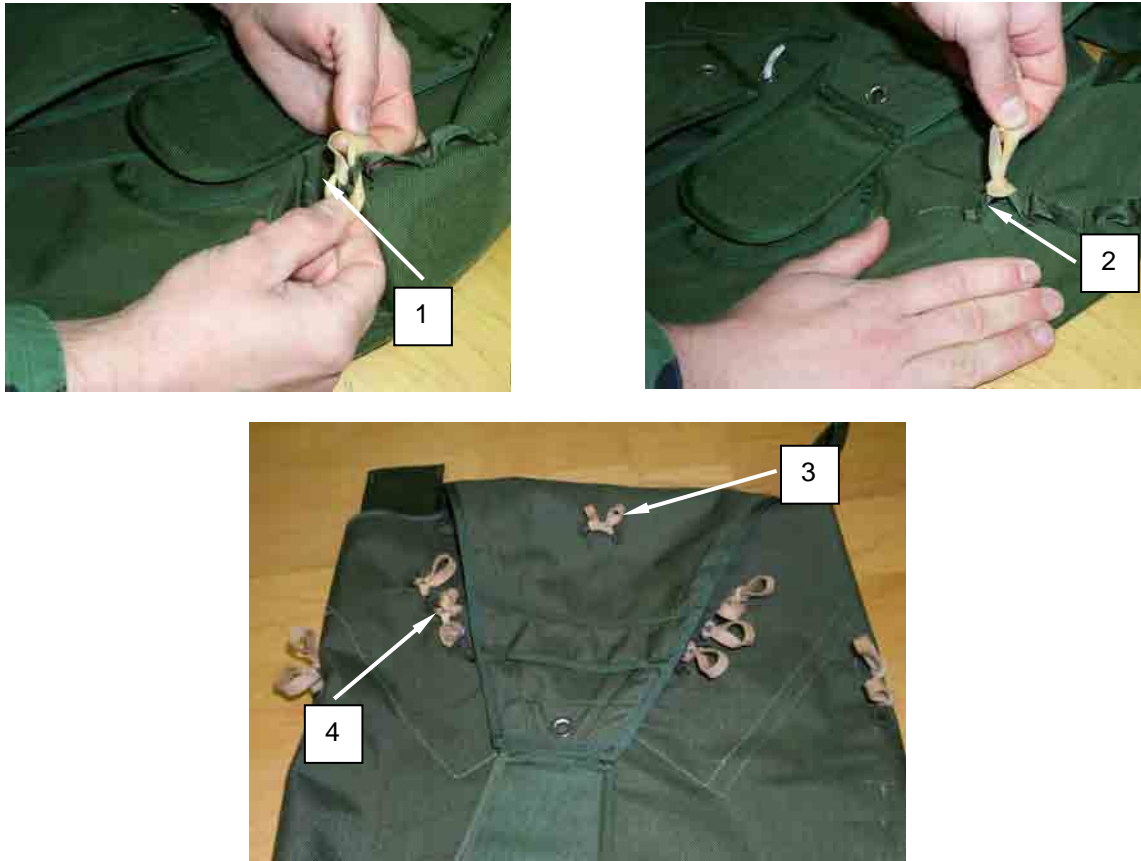

Figure 16. Attaching Retainer Bands to Static Line Stow Bars and Static Line Slack Retainer.

END OF TASK

ASSEMBLY – CONTINUED**Attach Main Closing Loop to Main Pack Tray**

1. Route the main closing loop (Figure 17, Item 1) under the main closing loop protective cover (Figure 17, Item 2) and through the grommet (Figure 17, Item 3).
2. Rotate the closing loop tab (Figure 17, Item 4) 90 degrees clockwise.

CAUTION

Do not attempt to tack through stiffener. Failure to heed caution will result in damage to the stiffener.

3. Using two 12-inch lengths of one turn double, lacing and tying tape (Figure 17, Item 5), tack both sides of the closing loop protective cover (Figure 17, Item 6).
4. Secure with a surgeon's knot locking knot to the inside of the pack tray. Trim the ends to within ½ inch.

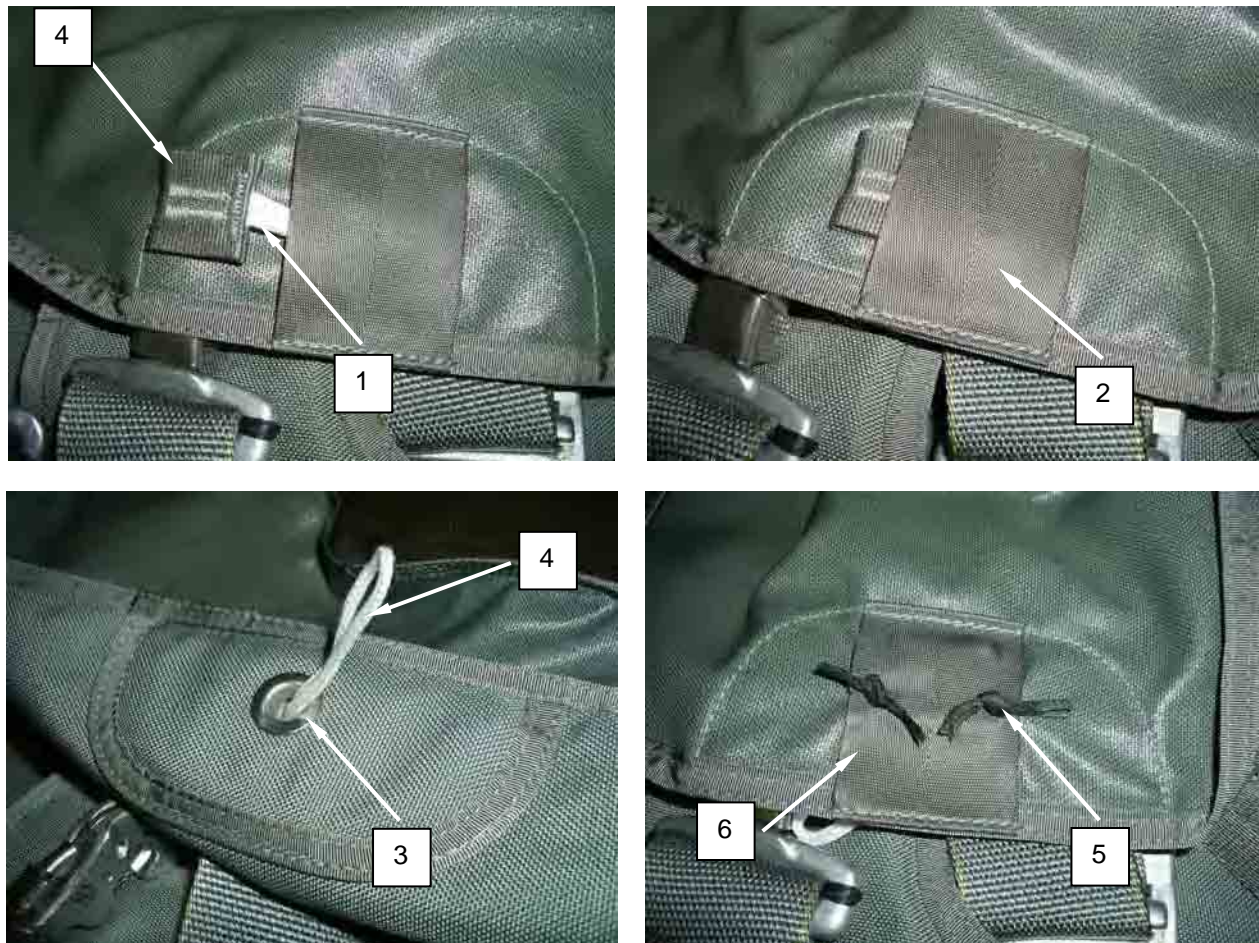

Figure 17. Routing Main Closing Loop under Protective Cover, through Grommet, and Tacking Both Sides.

END OF TASK

ASSEMBLY – CONTINUED**Attach Risers to Harness Assembly**

1. Place the assembled harness assembly and pack tray (Figure 18, Item 1) on the packing table between the lower end of the packing table and the male fitting (Figure 18, Item 2) of the CRA.
2. Extend the riser assemblies so that slip assist tabs are facing up, the pack tray is against the table, the harness assembly is oriented with the canopy release assemblies on top, and the upper closing flap (Figure 18, Item 4) is facing toward the upper end of the packing table.
3. Ensure both the riser assemblies (Figure 18, Item 3) and harness assembly are free of turns, tangles and twists.
4. Seat the male fitting (Figure 18, Item 2) of the CRA into the female fitting (Figure 18, Item 5), by placing the heel of the male fitting into the groove of the female fitting.
5. Fit the toe of the male fitting into the slot of the female fitting, close the latch (Figure 18, Item 6), and ensure the latch is securely locked.
6. Operate the latch and check for smooth operation. Close the latch.
7. Position the cable loop (Figure 18, Item 7) so that it sits below the lower end of the latch.
8. Fit the heel of the safety clip (Figure 18, Item 8) into the slot of the latch (Figure 18, item 9).
9. Close the safety clip.
10. Repeat for the opposite side.

ASSEMBLY – CONTINUED

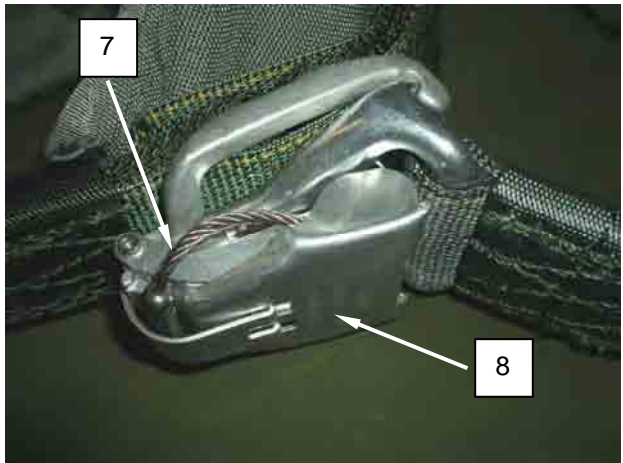
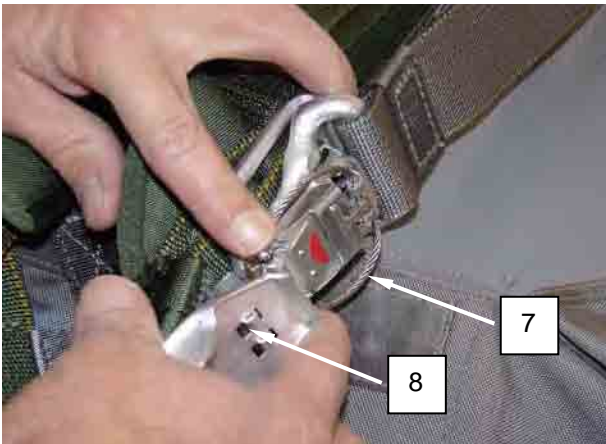
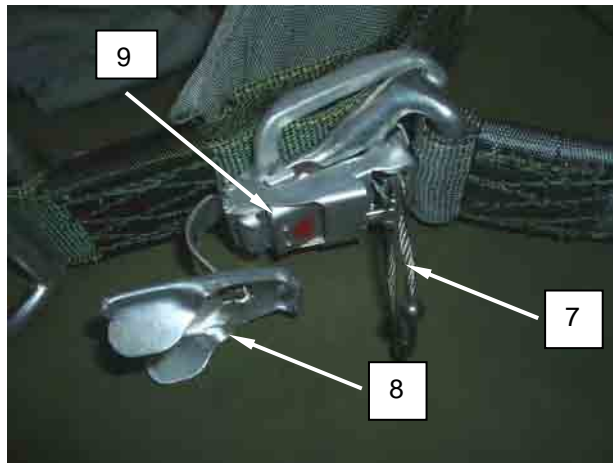
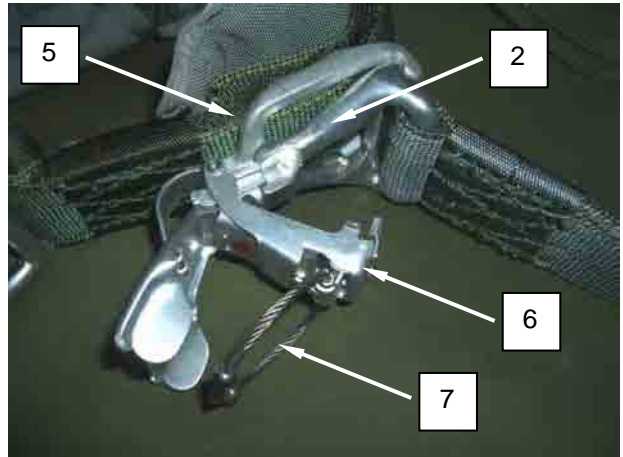

Figure 18. Laying Out Risers and Harness Assembly, and Assembling Risers and Harness Assembly.

END OF TASK

ASSEMBLY – CONTINUED

Attach the Drogue Parachute

1. Route the drogue parachute attaching loop (Figure 19, Item 1) at the top of the sleeve (Figure 19, Item 2) through the three plies of the looped end (Figure 19, Item 3) of the drogue parachute (Figure 19, Item 4).

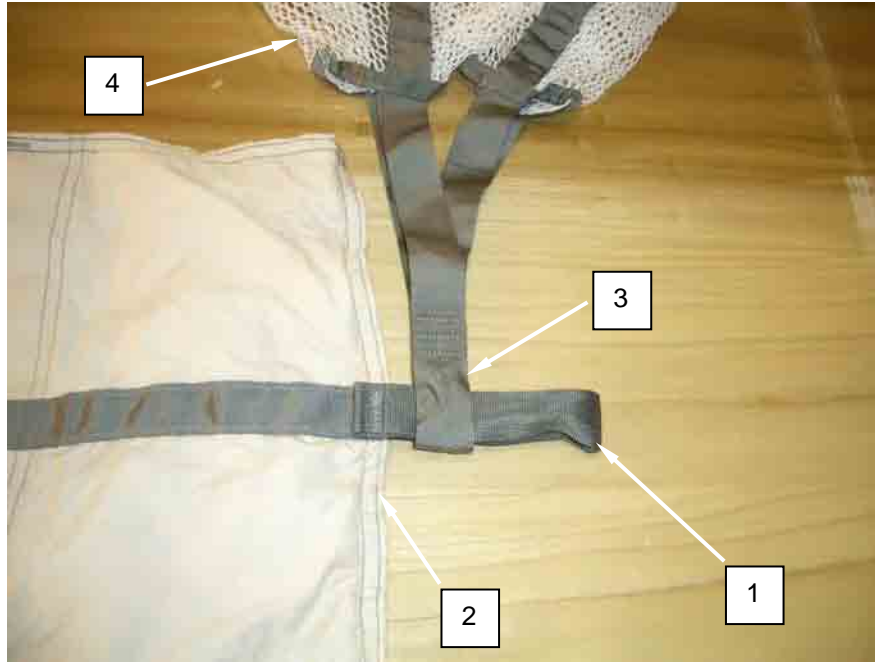

Figure 19. Sliding Looped End of Drogue Parachute over Drogue Parachute Attaching Loop.

2. Route the top (Figure 20, Item 1) of the drogue parachute (Figure 20, Item 2) through the drogue parachute attaching loop (Figure 20, Item 3).



Figure 20. Route Top of Drogue Parachute through Drogue Parachute Attaching Loop.

ASSEMBLY – CONTINUED

3. Pull the drogue parachute (Figure 21, Item 1) completely through the drogue parachute attaching loop (Figure 21, Item 2) to create a girth hitch (Figure 21, Item 3). Pull to tighten and secure.

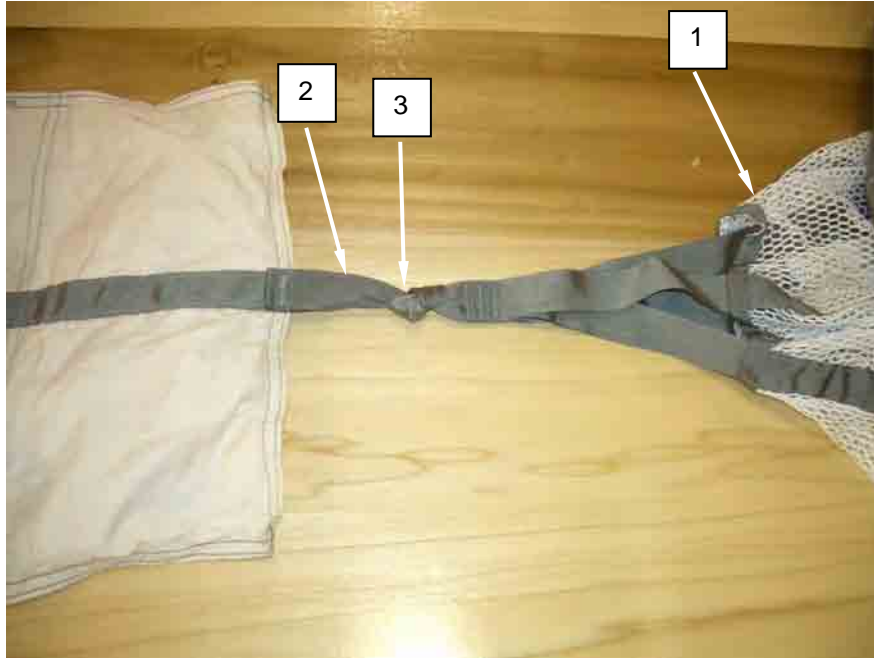

Figure 21. Pulling Drogue Parachute through Drogue Parachute Attaching Loop to Form Girth Hitch.

4. Secure the bridle ring (Figure 22, Item 1) at the top of the main canopy to the quick release hook (Figure 22, Item 2).

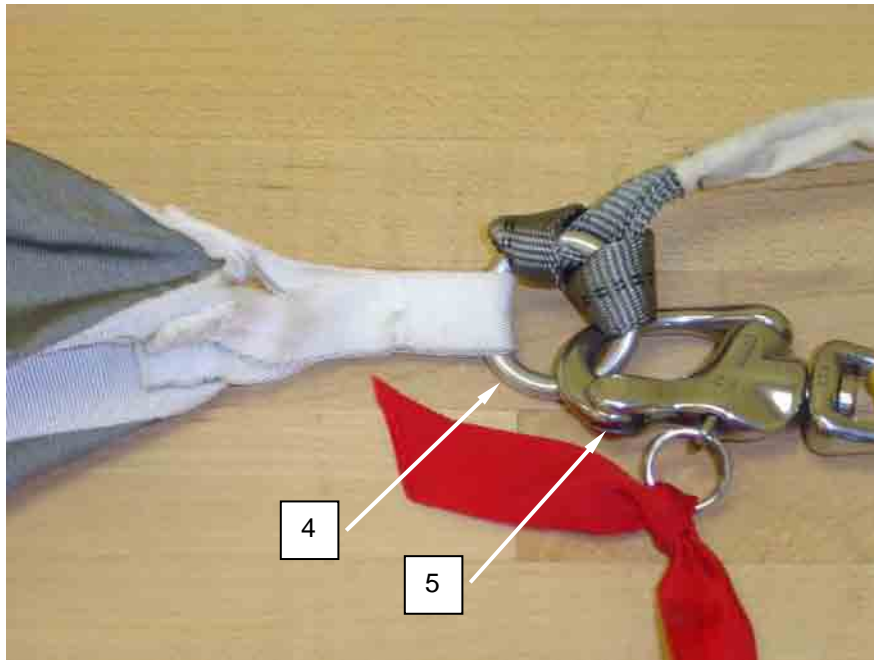

Figure 22. Attaching Bridle Ring to Quick Release Hook.

END OF TASK

ASSEMBLY – CONTINUED

Attach the Main Parachute Bridle Line

1. Remove bridle ring from quick release hook. Attach the main parachute bridle line (Figure 23, Item 1) with the cotton buffer end (Figure 23, Item 2) to the bridle ring (Figure 23, Item 3) at the top of the canopy (Figure 23, Item 4) with a girth hitch (Figure 23, Item 5).

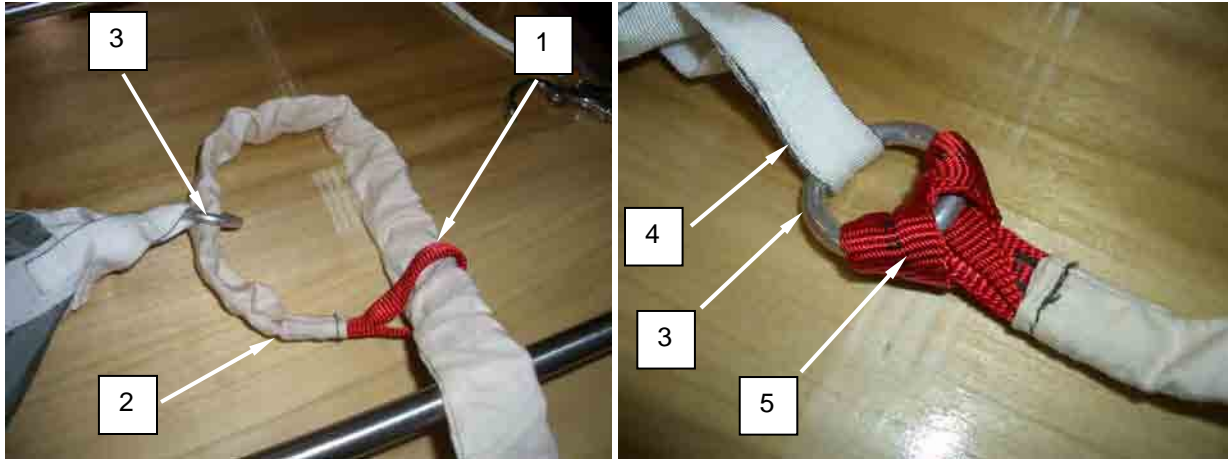

Figure 23. Attaching Bridle Line to Bridle Ring at Top of Canopy.

2. Route the opposite end of the main parachute bridle line (Figure 24, Item 1) through the bottom of the deployment sleeve (Figure 24, Item 2) (bottom of sleeve is identified by the data panel) and out through the top of the sleeve (Figure 24, Item 3).

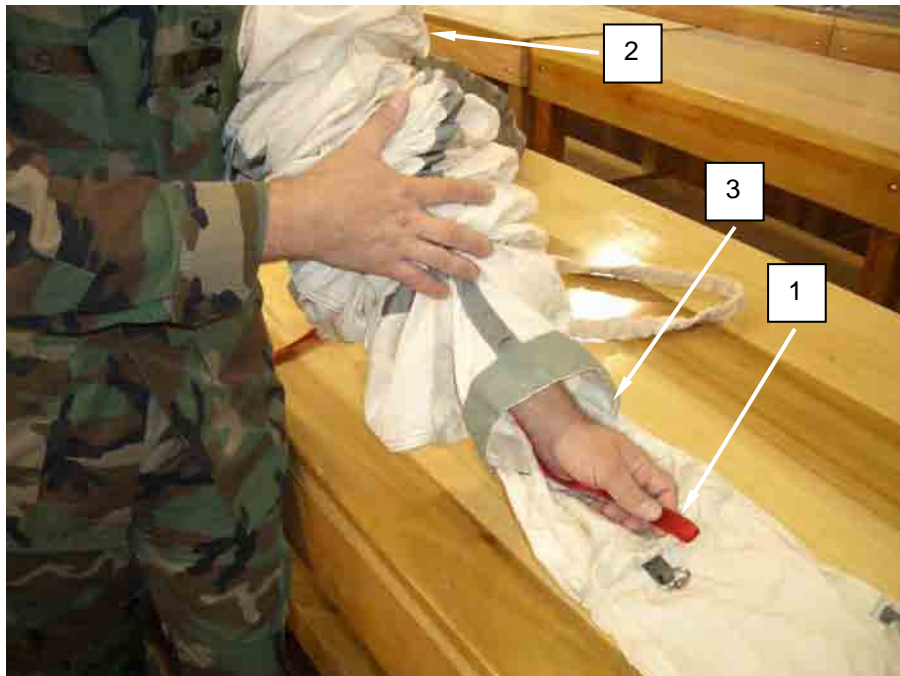

Figure 24. Routing Opposite End of Bridle Line through Bottom of Sleeve.

ASSEMBLY – CONTINUED

3. Attach the small connector link (Figure 25, Item 1) to the end of the main parachute bridle line (Figure 25, Item 2) and the connector link loop (Figure 25, Item 3) located at the top (Figure 25, Item 4) of the deployment sleeve.

CAUTION

Do not use vise grips or other type pliers to hold connector link body when tightening, as damage to connector link can occur.

4. Ensure barrel nut (Figure 25, Item 5) closes toward the bridle line, with barrel nut on right (Rigger's view), and is finger tight.



Figure 25. Connecting Bridle Line Link to Connector Link Loop on Sleeve.

NOTE

The 2-inch retainer bands are commonly known as large. The 1¼-inch retainer bands are commonly known as small.

5. Girth hitch two large retainer bands (Figure 26, Item 1) to the deployment sleeve bridle line stow panel (Figure 26, Item 2), one on each bridle line stow bar (Figure 26, Item 3).

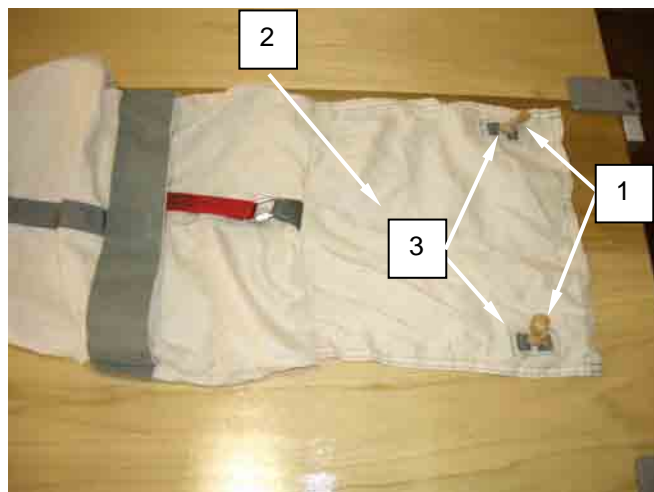

Figure 26. Attaching Retainer Bands to Deployment Sleeve Bridle Line Stow Panel.

END OF TASK

ASSEMBLY – CONTINUED**Attach 15-Foot Universal Static Line Modified (with Curved Pin) and Universal Static Line Extension to the Deployment Bag****NOTE**

Once the 15-foot Universal Static Line (USL) Modified (with Curved Pin) and the USL Extension have been used in a parachute deployment from an aircraft, the webbing will stretch while it is under tension; therefore, it will never return to its original manufactured dimension. That original manufactured dimension is what determines the serviceability at the in-service inspection.

When laying out the 15-foot Modified USL or the USL extension to form the girth hitch, ensure the green ID marking thread of the webbing is on the top.

Attaching the 15-foot Modified USL to the Deployment Bag.

1. Position the deployment bag (Figure 27, Item 1) with the stow loops (Figure 27, Item 2) on top with the opening of the bag facing the lower end of the table.
2. Pass the 6-inch buffer loop (Figure 27, Item 3) of the static line (Figure 27, Item 4) right to left, halfway through the deployment bag static line attachment loops (Figure 27, Item 5) ensuring that it passes behind both plies.

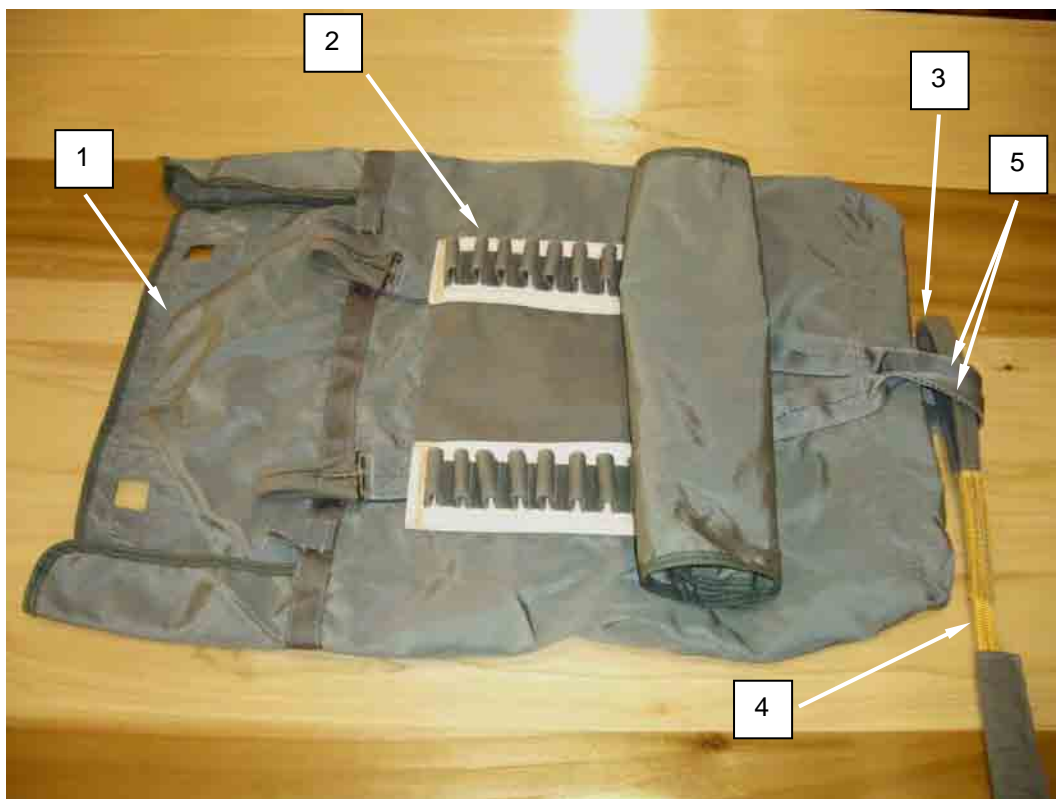

Figure 27. Passing the 6-inch Buffer Loop through Deployment Bag Reinforcement Webbing.

ASSEMBLY – CONTINUED

3. Pass the 3½-inch loop end (Figure 28, Item 1) of the static line (Figure 28, Item 2) through the 6-inch buffer loop (Figure 28, Item 3) counterclockwise.

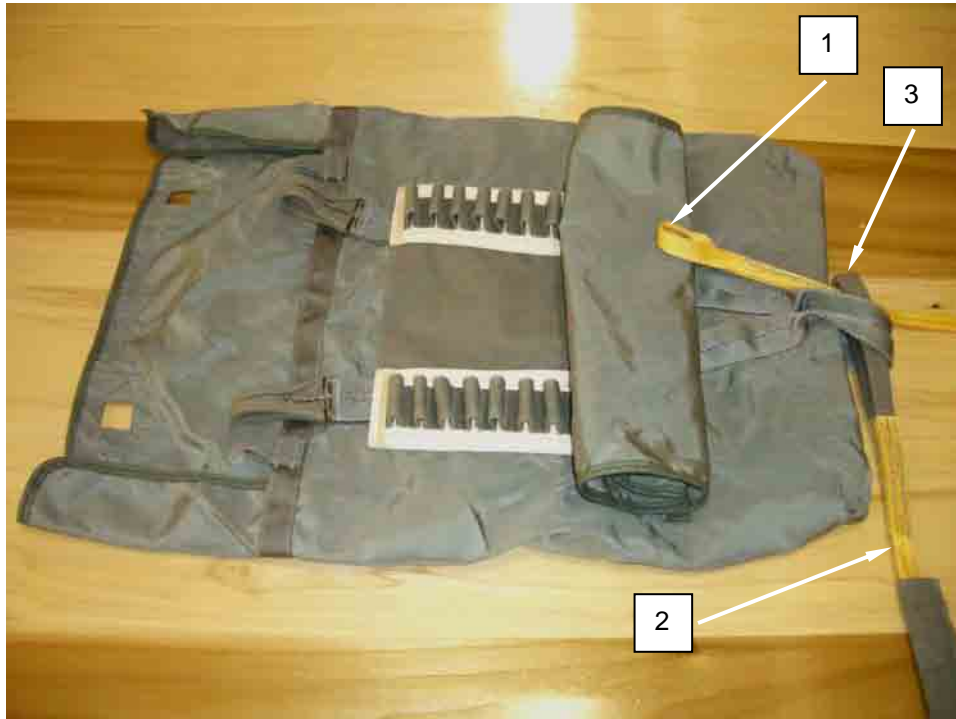

Figure 28. Passing Loop End of Universal Static Line through Buffer Loop.

4. Continue to pull the 3½-inch loop end of the static line until a tight girth hitch is formed (Figure 29, Item 1).



Figure 29. Securing Static Line to Deployment Bag.

END OF TASK

ASSEMBLY – CONTINUED**Attach the Snap Hook to the Modified USL, or the USL Extension.**

1. Position the snap hook (Figure 30, Item 1) so the opening gate (Figure 30, Item 2) is facing left, from Rigger's view. Lay the static line (Figure 30, Item 3) flat on the packing table. Ensure that the green ID marking thread (Figure 30, Item 4) is on top and on the outside of the loop.

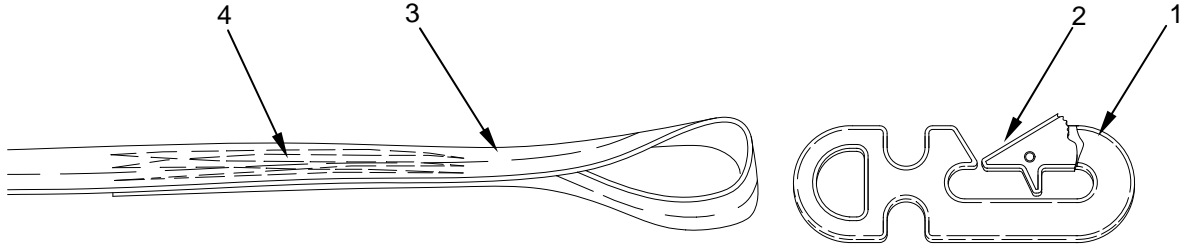

Figure 30. Positioning Static Line and Snap Hook.

2. Pass the 3½-inch loop end (Figure 31, Item 1) of the static line (Figure 31, Item 2) through the opening (Figure 31, Item 3) in the base of the snap hook (Figure 31, Item 4), from bottom to top.

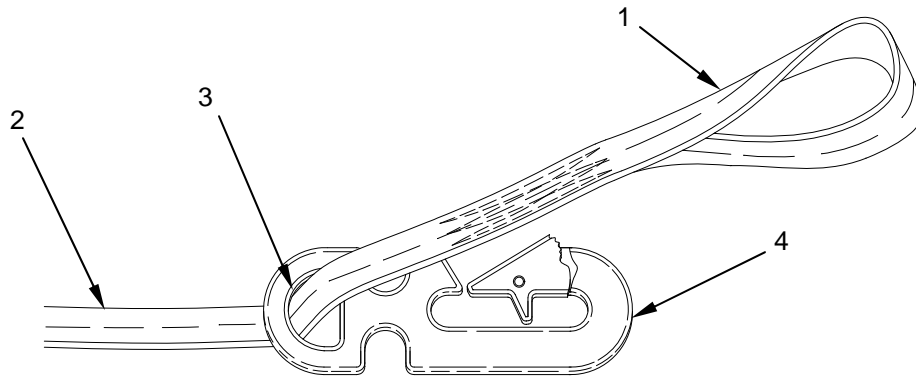

Figure 31. Passing Loop End of Static Line through Base of Snap Hook.

3. Pass the top of the snap hook (Figure 32, Item 1) through the 3½-inch loop end of the static line (Figure 32, Item 2).

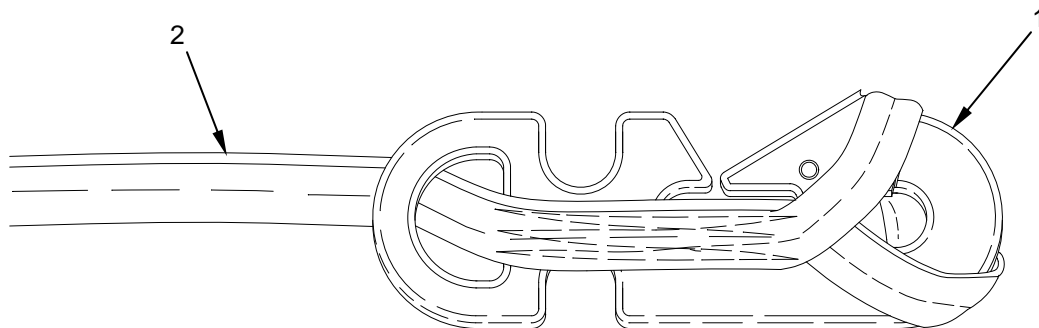

Figure 32. Passing Top of Snap Hook through Loop End of Static Line.

ASSEMBLY – CONTINUED

4. Continue passing the snap hook (Figure 33, Item 1) through the 3½-inch loop end (Figure 33, Item 2); pull the excess static line back through the opening (Figure 33, Item 3) in the base of the snap hook until the loop is past the snap hook opening.
5. Slide the loop down to the bottom of the snap hook (Figure 33, Item 1) until the static line (Figure 33, Item 4) is fully seated in the indent (Figure 33, Item 5) on the side of the snap hook; form a taut girth hitch.

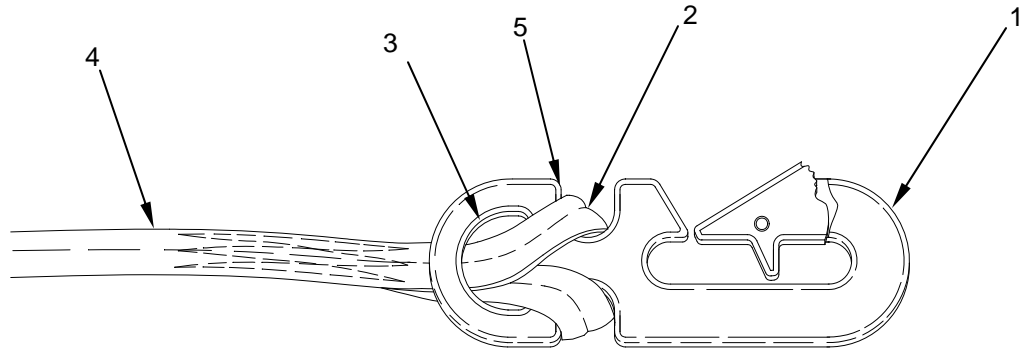

Figure 33. Sliding Loop Down to Bottom of Snap Hook.

6. Ensure there are no twists in the static line snap hook loop.

END OF TASK

NOTE

Before forming the girth hitch, the green ID marking thread on the USL and USL extension must be on top and on the outside of the loop.

Attaching the USL Extension to the 15-foot Modified USL.

1. Attach the snap hook to the USL extension in accordance with section "Attaching Snap Hook to the Modified USL, or USL Extension."
2. Pass the 3½-inch loop (Figure 34, Item 1) on the static line (Figure 34, Item 2), through the 2-inch buffer loop (Figure 34, Item 3), on the USL extension (Figure 34, Item 4).

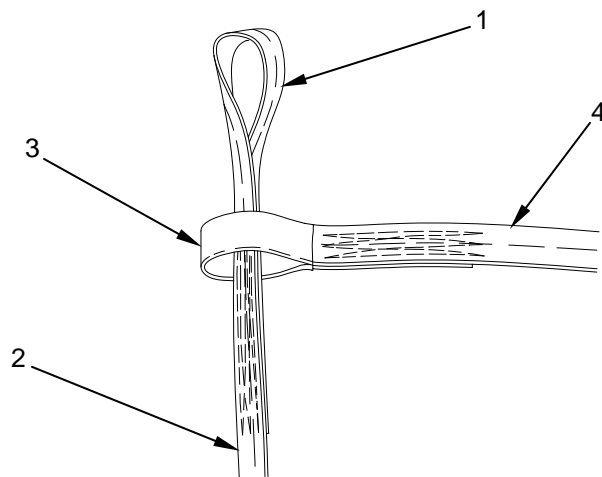

Figure 34. Passing Loop of Static Line through Buffer Loop on USL Extension.

ASSEMBLY – CONTINUED

3. Pass the snap hook (Figure 35, Item 1) of the USL extension (Figure 35, Item 2) through the 3 ½-inch loop (Figure 35, Item 3), on the static line (Figure 35, Item 4).

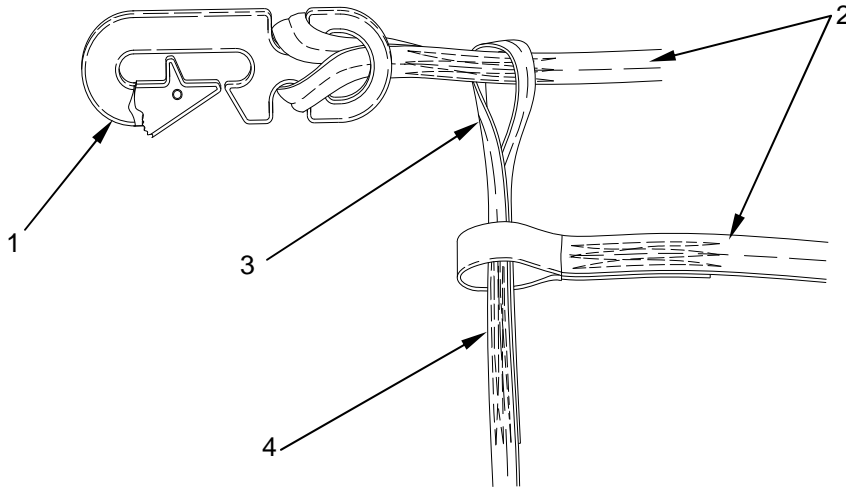

Figure 35. Passing Snap Hook of USL Extension through Loop on Static Line.

4. Continue passing the snap hook through the 3 ½-inch loop until a taut girth hitch (Figure 36, Item 1) is made securing the USL extension (Figure 36, Item 2) to the static line (Figure 36, Item 3) (there will be a half-twist in the 3 ½-inch loop when forming the girth hitch).

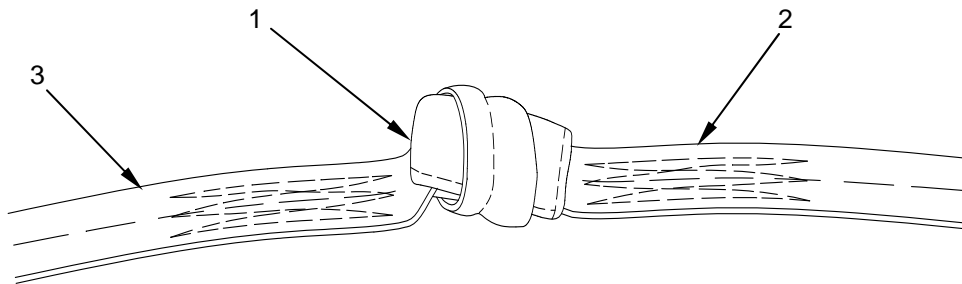

Figure 36. Making Girth Hitch Securing USL Extension to Static Line.

END OF TASK

ASSEMBLY – CONTINUED

Completing a Log Record Entry

Upon completion of the first technical/rigger-type inspection, the individual performing the inspection will initially prepare a log record for an individual parachute, or applicable type parachute harness assembly, and complete subsequent record entries using the following procedures:

NOTE

Log record book entries will be made with a suitable type blue or black marking device that cannot be erased (no felt tip markers).

Inside Front Cover. Using the information provided on the parachute canopy data block, make the following entries on the inside front cover of the log record (Figure 37). Entries may be continued on the inside of the back cover, if necessary.

NOTE

A parachute canopy serial number is recorded in a log record as a method of establishing control for maintenance, Equipment Improvement Report (EIR) and Product Quality Deficiency Report (PQDR) documentation, and to ensure the correct original record is reattached should the record become detached.

- Serial Number. Enter the parachute canopy assembly serial number.
- Type. Enter the parachute type.
- Part number. Enter the part number of the parachute canopy.
- Date of Manufacture. Enter the month and year the parachute canopy was manufactured.
- Manufacturer. Enter the name of the parachute canopy manufacturer.
- Canopy Contract Number. Enter the entire contract number specified for the parachute canopy.
- Mo/Yr Canopy Placed in Service. Enter the month and year that the canopy was placed in service.
- Station and Unit. Enter the name of the station and unit to which the parachute canopy is currently assigned. When a parachute is transferred permanently to another station, and/or unit, the original entry will be lined out and the name of the receiving station, and/or unit, will be entered.

SERIAL NO. _____ ○

TYPE _____

PART NO. _____

DATE OF MFG. (Month & Year) _____

MANUFACTURER _____

CANOPY CONTRACT NO. _____

MO/YR CANOPY PLACED IN SERVICE _____

STATION & UNIT _____

(Continued on inside back cover)

Figure 37. Inside Front Cover.

ASSEMBLY – CONTINUED

Inside Back Cover. Entries may be continued on the inside back cover, if necessary (Figure 38).

Figure 38. Inside Back Cover.

Modification Work Order (MWO) Compliance Record Page. When a modification is performed on a parachute canopy, the following entries will be made on the Modification Work Order Compliance Record pages of the log record, as follows:

- MWO Number. Enter the publication number and date of the MWO (Figure 39).
- MWO Title. Enter a short, abbreviated title extracted from the MWO prescribing the work.
- Modified by. Enter the last name of the individual who has performed the modification. If the original log record for the parachute has been lost, and it has been ascertained through inspection that a particular modification has been performed, the entry for this column will be C/W, (complied with), which signifies the applicable MWO has been complied with.
- Inspected by. The individual who performed the inspection, required after modification, will sign this entry with last name only.
- Unit. Enter the unit designation responsible for performing the MWO or, in the event of a lost log record, the unit to which the inspector is assigned.
- Date. Enter the day, month, and year the modification work was completed.

MODIFICATION WORK ORDER		COMPLIANCE RECORD					
MWO NUMBER	MWO TITLE	MODIFIED BY (NAME)	INSP. BY	UNIT	DATE		
					DAY	MONTH	YEAR
10-1670-292-20-1	Steering Orifice	Unknown	Hancock	SBCCOM	10	10	1992
10-1670-292-20-2	D-ring Replacement	Carver	Brown	SBCCOM	7	12	1996

- Legend**
- 1. Modification Completed By Unknown Due To Lost Original Log Record
 - 2. Modification Work Order Compliance Completed

Figure 39. Modification Work Order (MWO) Compliance Record Page.

ASSEMBLY – CONTINUED

Unit Repair and Inspection Data. When a parachute canopy assembly is initially received from a supply source, and a technical/rigger-type inspection is performed, the inspection will be documented on the Unit Repair and Inspection Data page of the individual parachute log record. Additional entries will also be made on this page each time the canopy assembly is repaired, or is administered an inspection, in compliance with a Safety of Use Message (SOUM), Ground Precautionary Message (GPM) or a Maintenance Advisory Message (MAM). The page completion criteria are as follows (Figure 40):

- Type of repair. Enter the type of repair performed, completion of initial inspection, SOUM, GPM, or MAM inspection compliance.
- Inspection by. The individual, who performed the inspection required, will sign this entry with last name.
- Unit. Enter the unit designation responsible for performing the type of repair.
- Date. Enter the day, month, and year the repair was performed.

UNIT & INTERMEDIATE		REPAIR & INSPECTION DATA				
TYPE OF REPAIR		INSP BY	UNIT	DATE		
				DAY	MONTH	YEAR
1 →	Initial Inspection	<i>Phillips</i>	SBCCOM	12	2	01
2 →	ISEC and 4 lines replaced	<i>Kididis</i>	SBCCOM	3	3	01
3 →	TB10-1670-213-2015	<i>Land</i>	SBCCOM	10	4	01

- Legend**
- 1. Completion of Initial Inspection
 - 2. Repair Performed
 - 3. SOUM, GPM, or MAM Inspection Compliance

Figure 40. Unit Repair and Inspection Data.

ASSEMBLY – CONTINUED

Notes Page. A page is provided at the back of a parachute log record to accommodate recording additional data pertinent to the serviceability of a parachute canopy assembly. This shall also include the month and year the item was placed in service (Figure 41).

	NOTES
Riser Mfg Date: Jan '86	
Placed in Service: Mar '86	
Immersed in Saltwater: 26/10/86	
Rinsed: 27/10/86	

Figure 41. Note Page.

Replacing a Filled Out or Unserviceable Log Record.**NOTE**

A parachute log record that is completely filled out, lost, illegible, or in an otherwise unserviceable condition, will be replaced with a serviceable log record. Local population sheets should be used to record all maintenance work orders (MWO's) performed on the system for historical data.

1. Using a suitable blue or black marking device, enter NEW BOOK on the outside front cover of the replacement log record.
2. Transcribe the information from the inside front cover of the original log record to the inside front cover of the replacement log record. If the original data is illegible or missing, use the canopy information data block to collect the required data.
3. In the replacement log record, transcribe the initial and last entry made on the Jump, Inspection, and Repack Data page of the original log record.
4. Transcribe all data from the remaining pages of the original log record to the appropriate pages of the replacement log record.
5. After all original data has been transcribed; file the original log record for historical purposes.

ASSEMBLY – CONTINUED**Replacing a Lost Log Record.****NOTE**

Any time a log record is discovered missing from a parachute, a replacement log record will be initiated during repack or inspection, as applicable.

1. Complete the log record inside front cover as prescribed above.
2. If it can be ascertained by inspection that a previous MWO, SOUM, GPM, or MAM has been complied with, applicable entries will be made on the appropriate page of the replacement log record.
3. Attach the replacement log record to the log record/inspection data pocket using the procedures above.

END OF TASK**END OF WORK PACKAGE**

FIELD MAINTENANCE
**RESERVE CANOPY
ASSEMBLY**

INITIAL SETUP:**Tools and Special Tools**

Crowfoot Attachment, Socket Wrench, 3/8-inch Drive, 7/16 Open end (WP 0102, Item 12)
 Needle, Upholsterers, Curved, Size 5 (WP 0102, Item 32)
 Packing Rod, Reserve Ejector Spring (WP 0102, Item 34)
 Ruler, Tab, Metal, 16 Inches (WP 0102, Item 46)
 Shears, Tailors, 12 inch (WP 0102, Item 61)
 Tape, Measuring (WP 0102, Item 65)
 T-Bar, Packing (WP 0102, Item 66)
 Test Tube, Spring Compression (WP 0102, Item 67)
 Wrench, Torque, 0-300 Inch-pounds (WP 0102, Item 74)

Personnel Required

Parachute Rigger 92R1P (2)

References

AFTO 391
 DA Form 3912
 WP 0014
 WP 0017
 WP 0058
 WP 0064
 WP 0086

Materials/Parts

Band, Rubber, Parachute, 1-¼-inch Long x 3/8-inch Wide (WP 0101, Item 2)
 Band, Rubber, Parachute, 2-inch Long x 3/8-inch Wide (WP 0101, Item 3)
 Cord, Fibrous, Nylon, MIL-C-5040H, Red, Type III (WP 0101, Item 15)
 Cord, Spectra®, #1000 (700 lb. tensile strength) (WP 0101, Item 18)
 Tape, Lacing and Tying, Nylon A-A-52080-B-3 (WP 0101, Item 41)
 Thread, Cotton, Ticket 8/4, Orange, A-A-52094 (WP 0101, Item 48)
 Webbing, Nylon, Cotton, Type 1, ¼-inch Wide, Natural (WP 0101, Item 67)

Equipment Condition

All equipment shall be serviceable and ready for use.

ASSEMBLY

Assembly procedures begin on next page.

ASSEMBLY – CONTINUED**WARNING**

Assembly of the reserve canopy shall be completed in accordance with the following procedures. Failure to do so may result in serious injury or death to the parachutist.

Marking Parachute Canopy

Prior to being placed into service, personnel parachutes that have had no previous use will be marked to reflect the date of entry into service. The marking will be made on the canopy information data block by stenciling the lettering in ½-inch characters using the marking and re-stenciling repair procedures detailed in WP 0018. Other applicable parachute components will be marked adjacent to existing data. The stenciled data will appear as Placed In Service (PIS) followed by the date, which will indicate the month and calendar year, such as "JAN 05." Ensure the added marking does not infringe upon, or obliterate, any original data on the information data block.

Marking Parachute Components

Reserve parachute components will be placed in service by placing the in-service date as follows: In-service date will be entered on the data label on each riser. Stencil the extractor in-service date near the data label. Harness assembly in-service date will be entered on the data panel on the lower saddle.

Assemble Reserve Pack Tray

Place two 2-inch retainer bands (Figure 1, Item 1) per retainer stow bar (Figure 1, Item 2).



Figure 1. Assembling the Reserve Pack Tray.

END OF TASK

ASSEMBLY – CONTINUED**Prepare the Ejector Spring**

1. Perform reserve ejector spring test IAW WP 0055.
2. Measure the reserve closing loop to ensure it is 12 inches \pm ¼-inch measured under hand tension.
3. Using the packing T-bar (Figure 2, Item 1), route the reserve closing loop (Figure 2, Item 2) through the reserve closing loop channel (Figure 2, Item 3) located at the bottom of the ejector spring (Figure 2, Item 4).



Figure 2. Assembling the Ejector Spring.

END OF TASK**Attaching Extractor**

1. Arrange the canopy on the pack table with gore 1 on top extending all the way to the upper lateral band.
2. Disconnect and remove the apex hook lanyard from the apex hook.

NOTE

Locate the extractor and ensure the extractor bridle lines and suspension lines are straight and free of twists. Ensure that the smooth side of the bridle line is facing outward and that the securing tie is tied so that the knots are tied to the inside.

3. Layout the extractor immediately above the upper lateral band, ensuring the extractor bridle lines are free of turns, tangles, and twists.

ASSEMBLY – CONTINUED

4. Locate the four extractor attaching loops (Figure 3, Item 1) attached to the upper lateral band at main seams 3, 8, 13 and 18. The extractor attaching loops are the foliage green loops on the upper lateral band.
5. Route one end of a 12-inch length of one turn single Spectra® 1000 cord (Figure 3, Item 2) through one end of the first extractor bridle line (Figure 3, Item 3), through the main seam at number 3 extractor attaching loop (Figure 3, Item 1), and back through the first extractor bridle line.
6. Draw tight and securely fasten the ends of the cord at the upper lateral band (Figure 3, Item 2) over the first extractor bridle line (Figure 3, Item 3) using a surgeon's knot, locking knot with a knot in the running end.
7. Trim excess to 1 inch.
8. Attach the second extractor bridle line to the extractor attaching loop at main seam number 8, the third extractor bridle line to the extractor attaching loop at main seam number 13, and the fourth extractor bridle line to the extractor attaching loop at main seam number 18 in the same manner as described above.

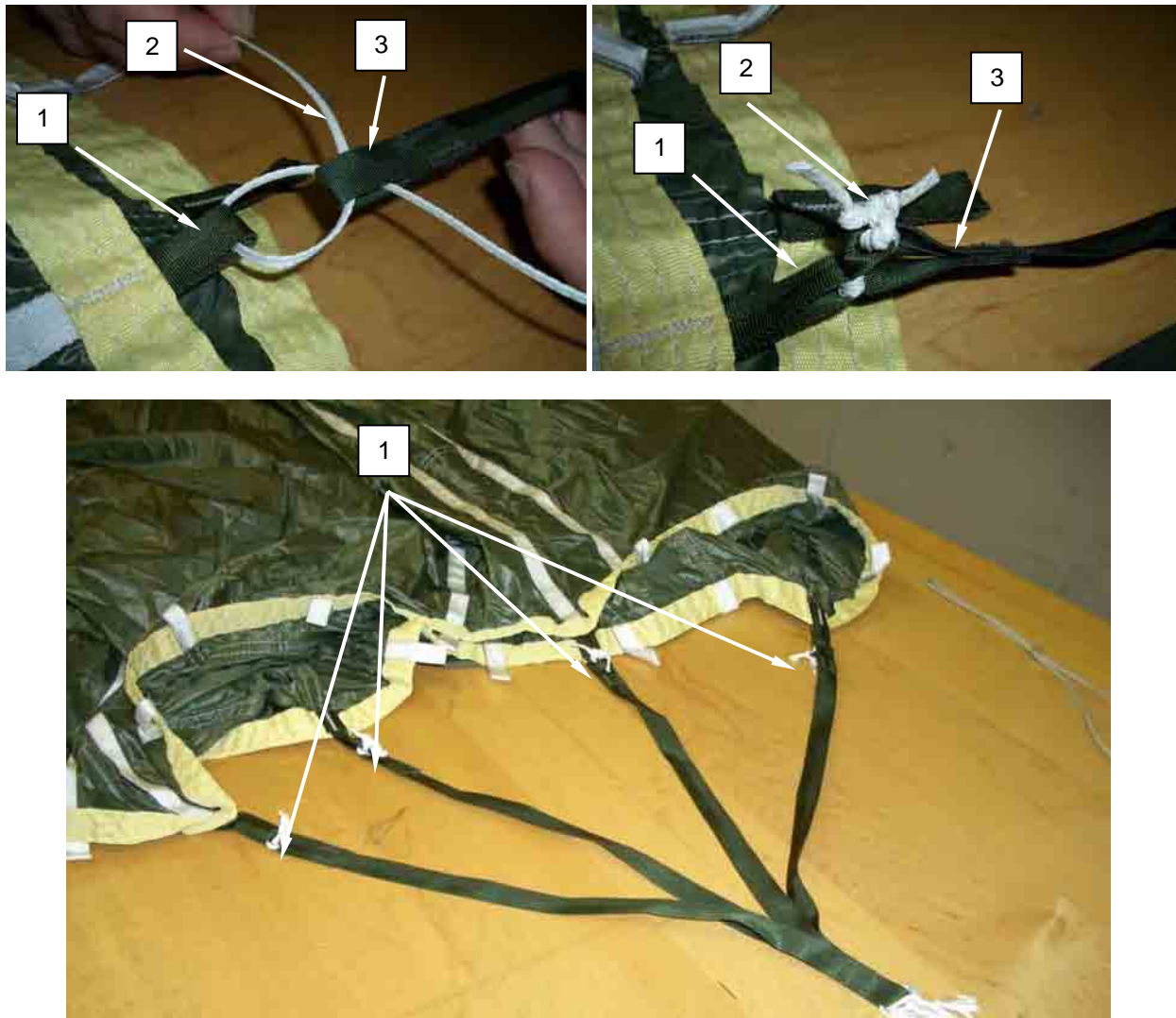

Figure 3. Attaching Extractor Bridle Lines.

END OF TASK

ASSEMBLY – CONTINUED**Attach the Reserve Risers to the Reserve Canopy****NOTE**

A packing T-bar may be used to assist in passing apex hook lanyard through loops on upper lateral band.

1. Temporarily secure the upper lateral band to the upper end of the pack table by passing the apex hook lanyard (Figure 4, Item 1) through all loops (Figure 4, Item 2) on the upper lateral band. Attach the apex hook lanyard to the apex hook (Figure 4, Item 3).
2. Layout reserve canopy on a pack table with the suspension line organizing card at the lower end of the pack table.

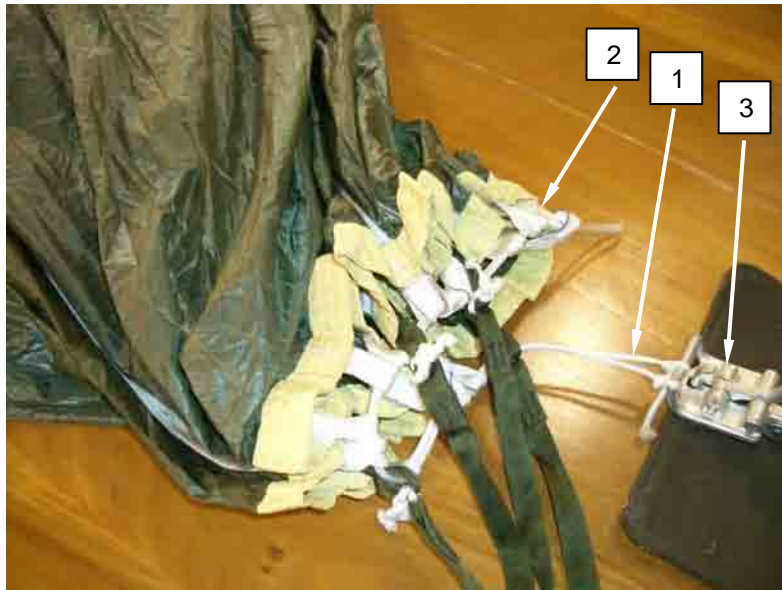

Figure 4. Attaching Packing Lanyard to Apex Hook.

NOTE

A line organizing card may be used to assist in group separation.

3. At the lower lateral band, split the canopy between the left and right line groups.

ASSEMBLY – CONTINUED

4. Layout the reserve risers (Figure 5, Item 1) directly behind the connector link groups ensuring there are no twists.
5. Evenly mate the hook and pile tapes between the reserve riser plies.
6. Ensure the gates of the connector snaps are facing downward and the butterfly portions of the connector snaps are facing outward, with the spreader bar laying flat with no twists.

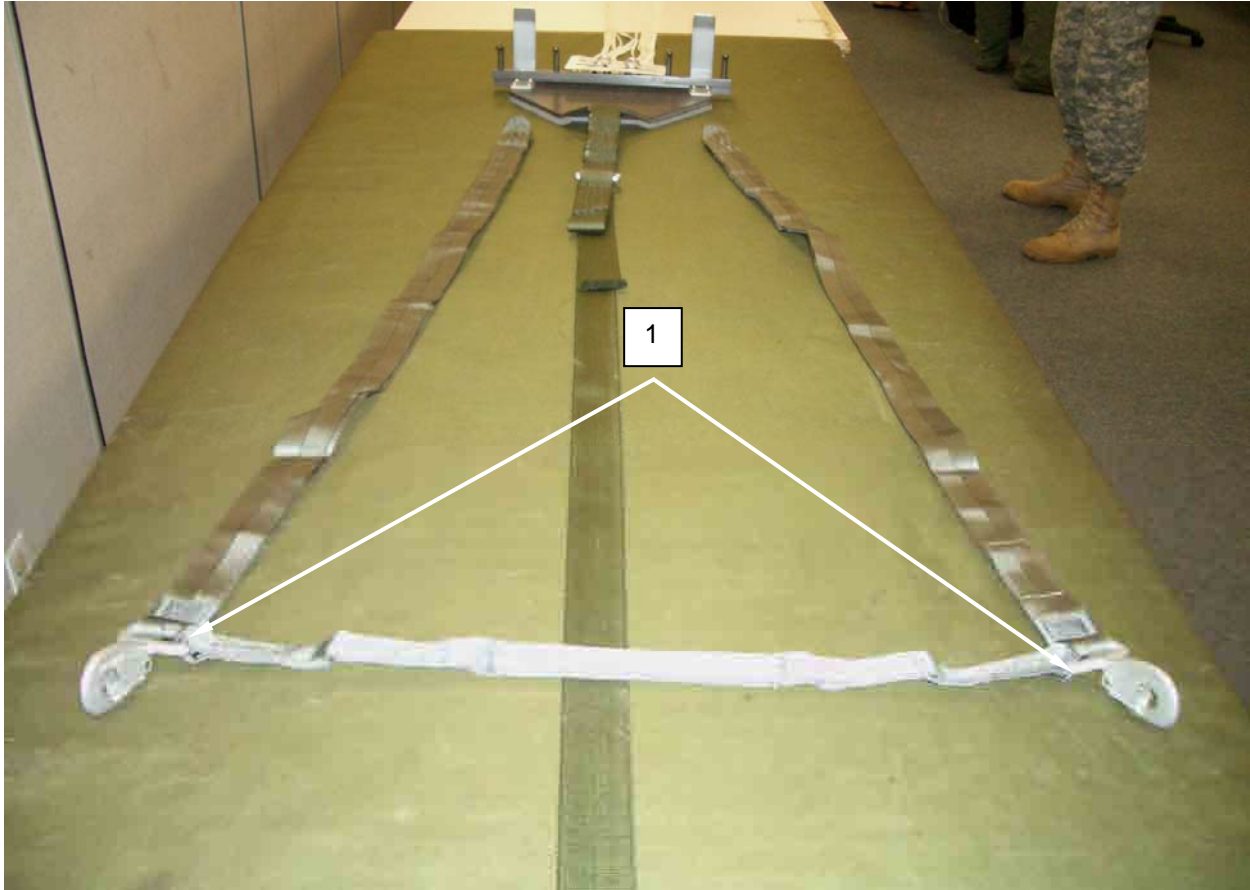

Figure 5. Laying Out Risers.

7. Completely open the barrel nut on the connector links (Figure 6, Item 1) and remove connector links from line organizing card. Once connector links are removed from organizing card, loosely close barrel nuts.

ASSEMBLY – CONTINUED**NOTE**

Connector link barrel nuts must be oriented so they face inboard and tighten downward.

Suspension lines 1 thru 20 are divided into two groups, number 1 thru 10 in the left group and number 11 thru 20 in the right group.

8. Place the left set of connector links (Figure 6, Item 1) on the left post (Figure 6, Item 2) of the tension plate adapter and the right set of connector links (Figure 6, Item 3) on the right post (Figure 6, Item 4) of the tension plate adapter.

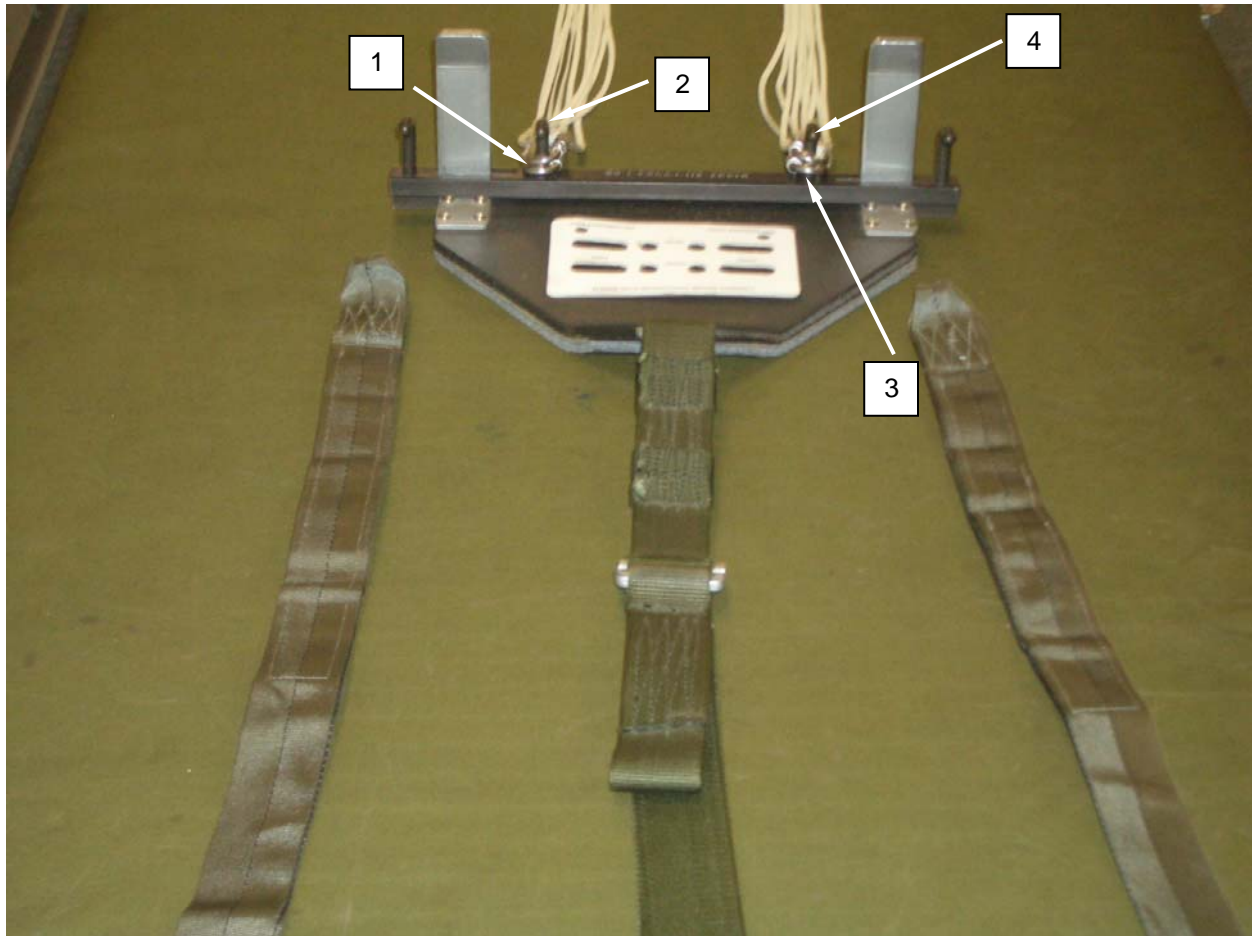

Figure 6. Riser Connector Links.

END OF TASK

ASSEMBLY – CONTINUED

100 % Line Continuity Check

NOTE

Two personnel are required for a line continuity check. The first person will be at the connector links to ensure lines are properly located on connector links. The second person will be at the lower lateral band calling off properly sequenced suspension lines.

1. Conduct a continuity check in accordance with Figure 7 below.
2. Top left suspension line group. Line 1 (inside top) followed in sequence by 2, 3, 4, 5 (outside top) runs from the canopy, to the top left connector link.
3. Bottom left suspension line group. Line 6 (outside bottom) followed in sequence by 7, 8, 9, 10 (inside bottom) runs from the canopy, to the bottom left connector link.
4. Bottom right suspension line group. Line 11 (inside bottom) followed in sequence by 12, 13, 14, 15 (outside bottom) runs from the canopy, to the bottom right connector link.
5. Top right suspension line group. Line 16 (outside top) followed in sequence by 17, 18, 19, 20 (inside top) runs from the canopy, to the top right connector link.



Figure 7. Suspension Line Groups.

END OF TASK

Secure Connector Links to Risers

1. If necessary, loosely connect connector links to appropriate riser.
2. Perform a four line check IAW “Perform a Four Line Check” in WP 0015.

ASSEMBLY – CONTINUED

CAUTION

Do not use vise grips or other type pliers to hold connector link body when tightening. Damage to connector link can occur.

NOTE

Ensure torque wrench is calibrated by TMDE office prior to use.

- Using a torque wrench with crowfoot adapter, tighten barrel nut (Figure 8, Item 2) on connector link (Figure 8, Item 3) to 50 inch-pounds (5.6 Newton meters).

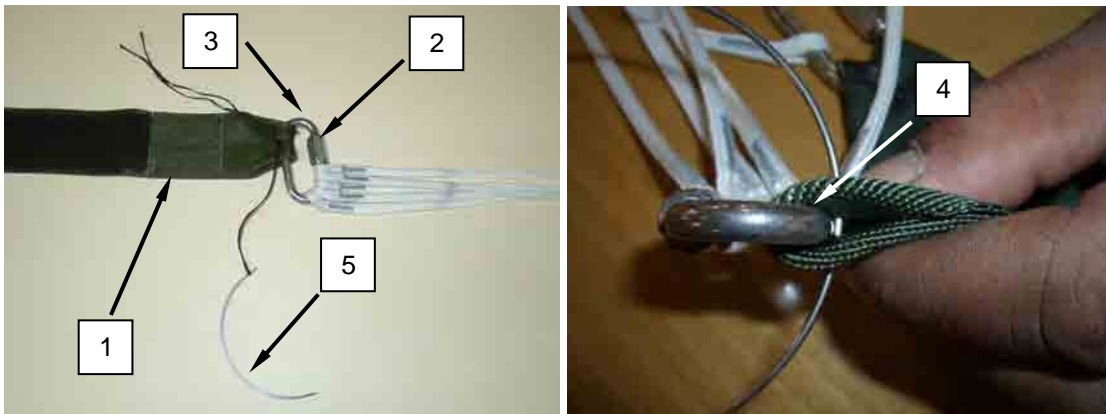
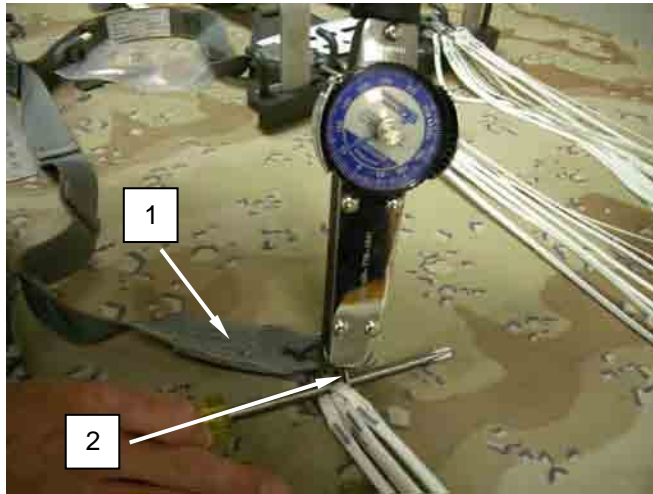

Figure 8. Tacking Reserve Risers.

- Remove connector links and risers from the tension plate adapter.
- Rotate the riser (Figure 8, Item 1) sideways on the long portion of the connector link (Figure 8, Item 3) positioning the riser to the long portion of the connector link opposite the barrel nut.
- Tack each riser (Figure 8, Item 1) with a 12-inch length of lacing and tying tape, one turn double (Figure 8, Item 4). Pass the upholsterer's needle (Figure 8, Item 5) tight against the body of the connector link (Figure 8, Item 3) with running ends toward top when finished.
- Secure with a surgeon's knot, locking knot, ensuring the knot is toward the top. Trim the running ends to ½-inch.

ASSEMBLY – CONTINUED

8. Rotate the connector link back in place (Figure 9, Item 1).

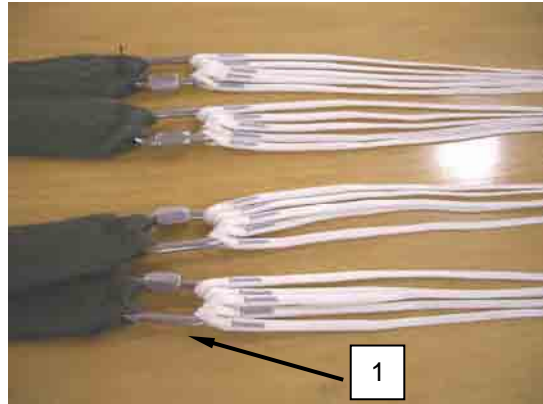

Figure 9. Rotating Risers to Lower Portion of Connector Link.

9. Reattach risers and connector links to tension plate adapter.

END OF TASK**Secure Spreader Bar to Pack Tray****NOTE**

Position pack tray on the packing table between tension plate and the lower end of the pack table. Orient the carry handle of the pack tray to the lower end of the packing table.

1. Place the pack tray under the risers with the connector snaps located at the carrying handle.
2. Cut two 10-inch pieces of Type III Nylon Cord, Guttled (Red) for the spreader bar attaching tie.

ASSEMBLY – CONTINUED

3. Route a 10-inch piece of Type III Nylon Cord, Guttled (Red) (Figure 10, Item 1) up through the lower grommet at the lower edge of pack tray (Figure 10, Item 2). Repeat for other side.

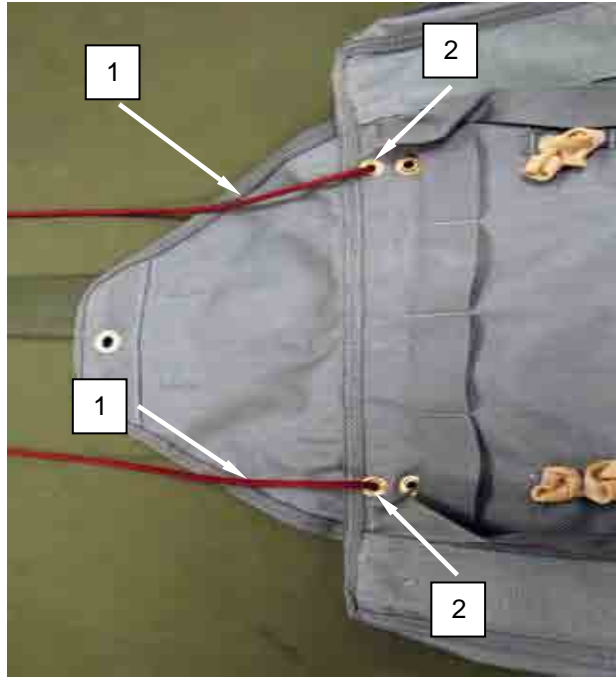

Figure 10. Routing Cord through Top Grommets of Pack Tray.

4. Center the spreader bar (Figure 11, Item 1) between the upper and lower grommets parallel to the lower edge of the pack tray.



Figure 11. Centering the Spreader Bar between the Upper and Lower Grommets.

ASSEMBLY – CONTINUED

5. Route 10-inch piece of Type III Nylon Cord, Guttled (Red) (Figure 12, Item 1) over the spreader bar (Figure 12, Item 2) and down through the upper grommet (Figure 12, Item 3). Repeat for other side.

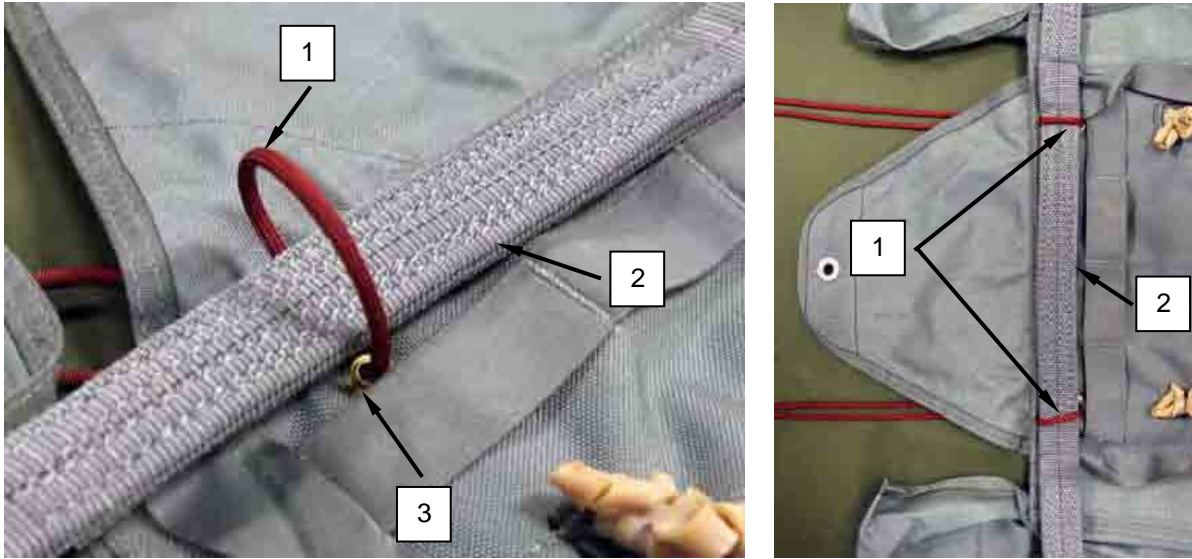

Figure 12. Routing Type III Nylon Cord Over Spreader Bar.

6. Secure the spreader bar on the back side of the pack tray by tying the Type III Nylon Cord, Guttled (Red) (Figure 13, Item 1) using a surgeon's knot, locking knot (Figure 13, Item 2) with an overhand knot (Figure 13, Item 3) in the running ends. Trim running ends to 1 inch.

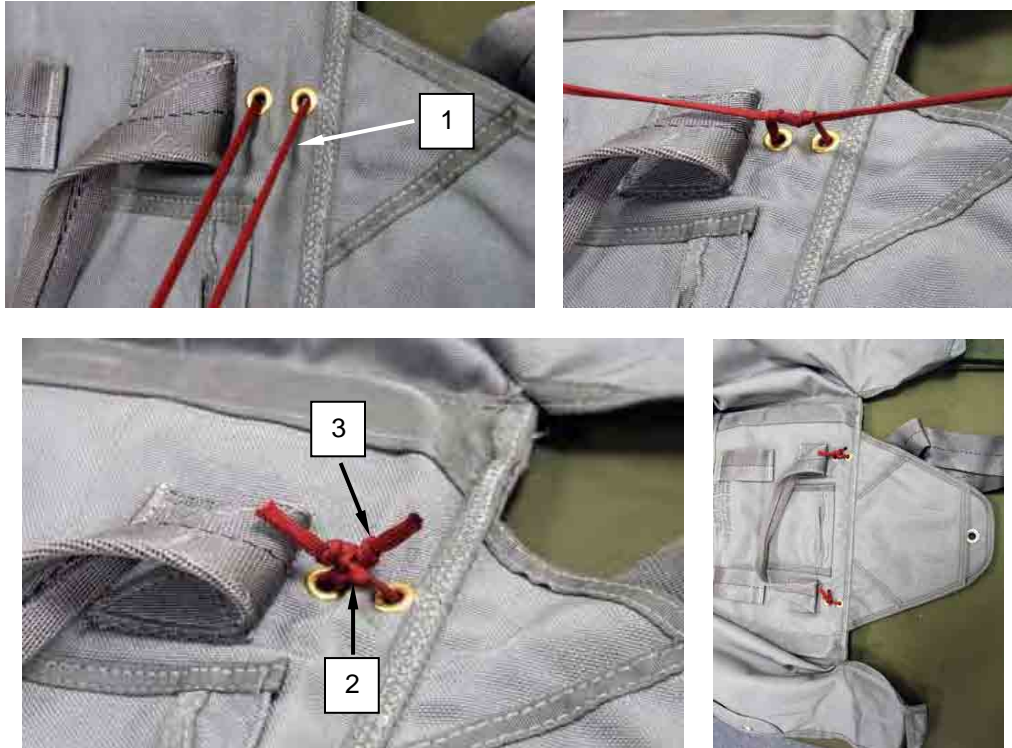

Figure 13. Securing the Spreader Bar on Back Side of Pack Tray.

ASSEMBLY – CONTINUED

7. Place the pile tape on the riser to the hook tape on the pack tray. Ensure that the top bar (Figure 14, Item 1) of each snap hook aligns with the top of the binding tape (Figure 14, Item 2). S-fold the excess of the spreader bar (Figure 14, Item 3) back onto itself.

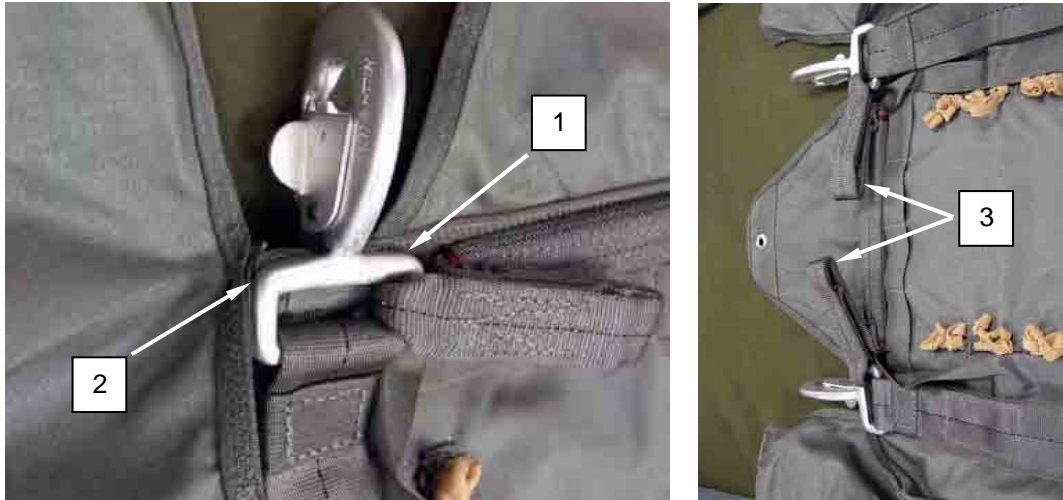

Figure 14. Aligning Top Bar of Snap Hook with Binding Tape and S-Folding Excess Spreader Bar.

ASSEMBLY – CONTINUED

8. Use an upholsterer's needle with a 24-inch piece of lacing and tying tape, one turn single, to attach the connector snap to the pack tray. Push the upholsterer's needle just below the binding tape, through the back of the pack tray, to the front in the middle of the connector snap (Figure 15).
9. Route the lacing tape around the throat of the connector snap.
10. Run the upholsterer's needle through the front of the pack tray to the back of the pack tray.
11. Both running ends should now be on the back side of the pack tray.
12. Route the running ends over the pack tray around the throat of the connector snap, and tie a surgeon's knot, locking knot. Trim the running ends to 1 inch.
13. Repeat steps 8 through 12 for the second connector snap.

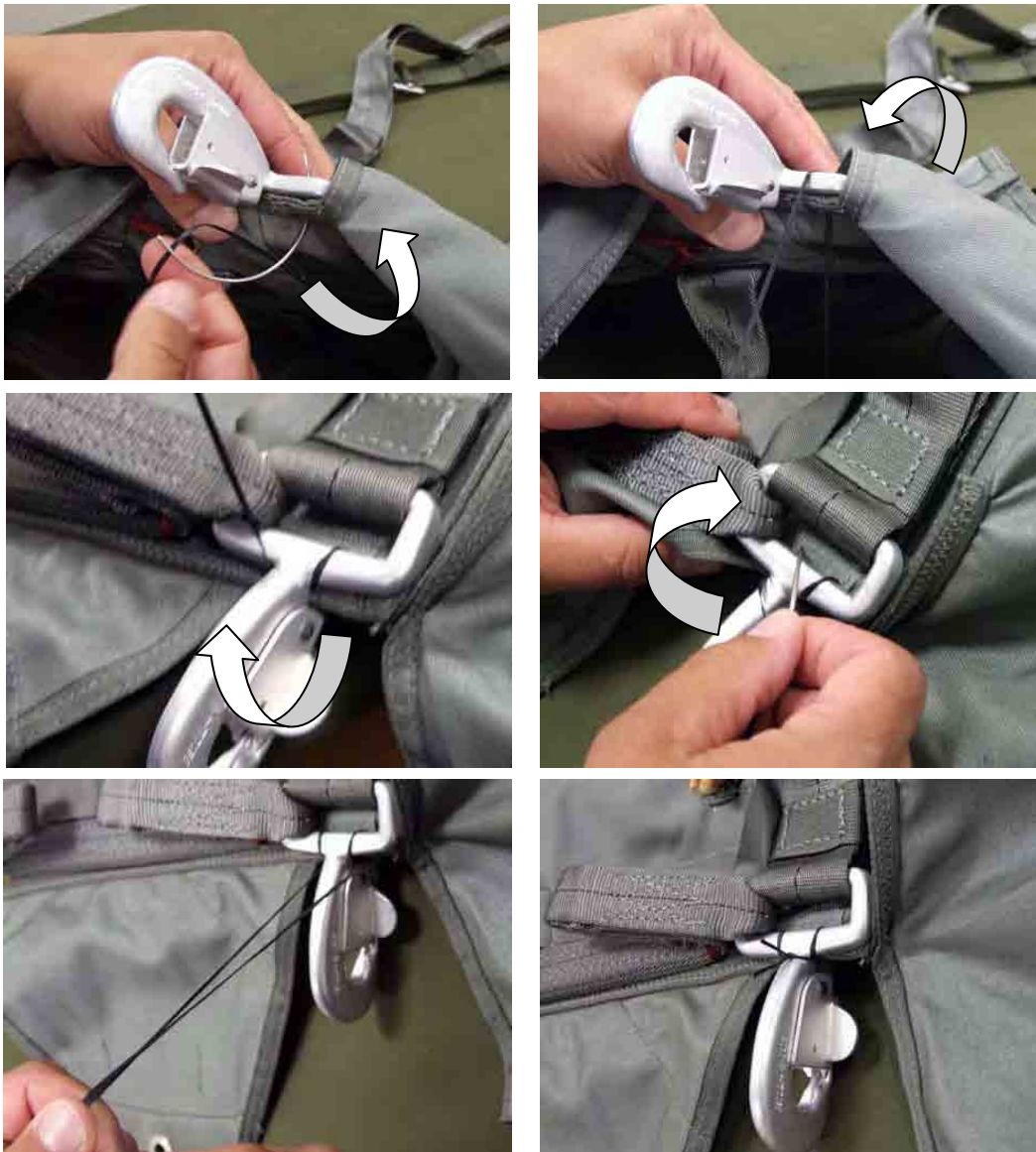

Figure 15. Securing Connector Snaps To Pack Tray.

ASSEMBLY – CONTINUED

14. Using an 8-inch piece of ticket 8/4 cotton thread (orange), route from the right side to the left side in a counter-clockwise direction between the plies of the excess fold-over from the spreader bar and back through the right side (Figure 16).
15. Tie a surgeon's knot, locking knot. Loop should be approximately 2½- to 3-inches long. Ensure tie is secured tightly.

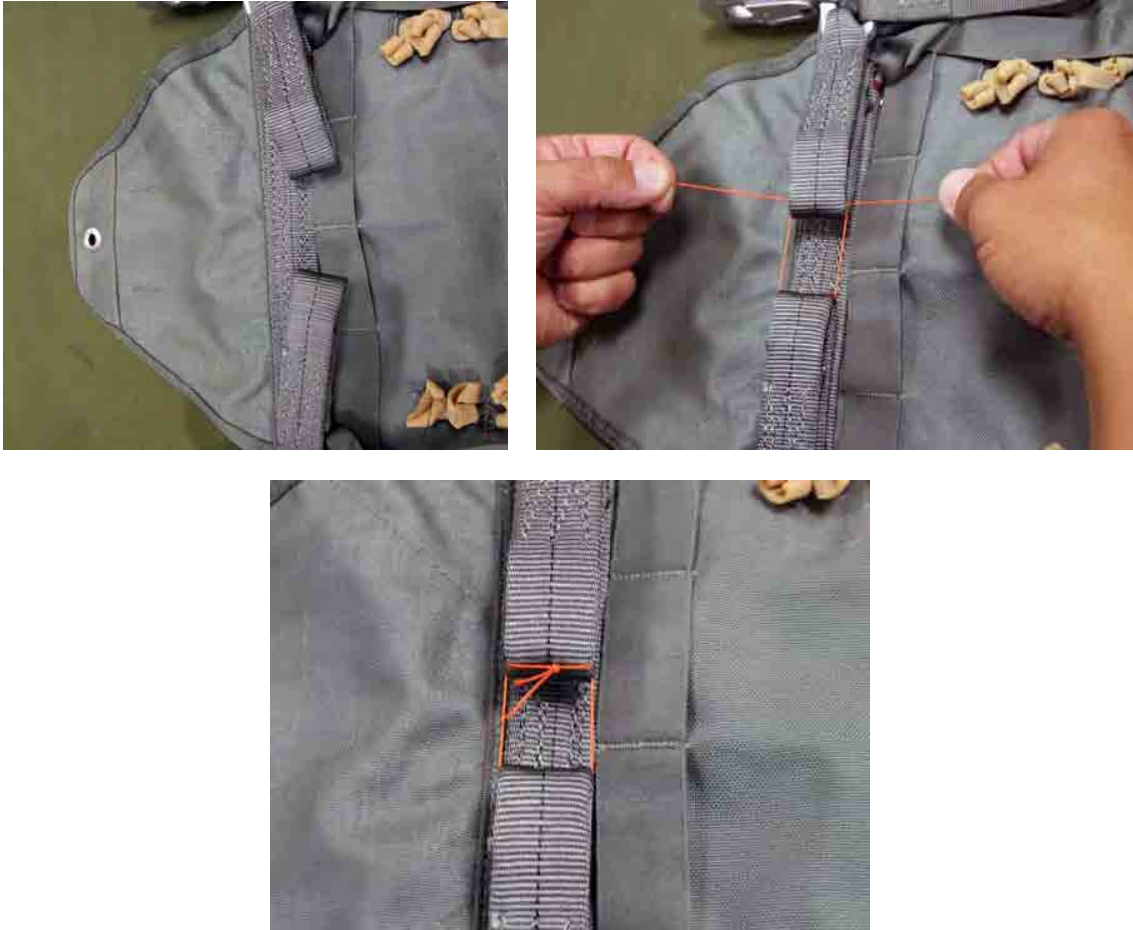

Figure 16. Securing the Excess Spreader Bar Fold-over.

END OF TASK

ASSEMBLY – CONTINUED

Parachute Log Record

The Army Parachute Log Record, DA Form 3912, AFTO 391 is a history-type maintenance document that accompanies the parachute canopy and pack tray assemblies through the period of service of the individual assembly. The log record provides a means of recording maintenance actions performed on a parachute canopy assembly. Normally, a log record is initiated and attached to a riser assembly upon receipt by a using unit. If the item is subjected to alteration or modification by a maintenance activity during the interim period from date of manufacture to receipt by a using unit, the log record will be prepared by the activity performing the maintenance function. Once initiated, a log record will be attached to, and contained in, an affixed parachute log record/inspection data pocket, until such time as the parachute canopy assembly is destroyed or rendered unfit for further use or repair.

Additionally, should an item that requires a log record, be transferred from one unit to another, the log record for the parachute assembly will accompany the item in the transfer action. A prepared log record will not be removed or separated from a parachute, and especially a packed parachute, except as directed by the local Airdrop Systems Technician (921A) or Senior Airdrop NCO (92R4P) and above, under guidance from an Airdrop Systems Technician assigned to the command at the Battalion level or higher, when no Airdrop Technician is assigned at the Company/Detachment/Team level.

A log record that is illegible, lost, damaged, soiled, or precludes further entries due to lack of space, will be replaced upon the next repack or inspection, as applicable, with a serviceable item from stock.

Installing Attaching Tie

Install attaching tie as follows:

1. Cut a 30-inch length of lacing and tying tape and double the lacing length.
2. Pass the looped end of the doubled lacing length around the centerfold of the log record, passing the running end through forming a slip loop on the outside, at the log record top (Figure 17).

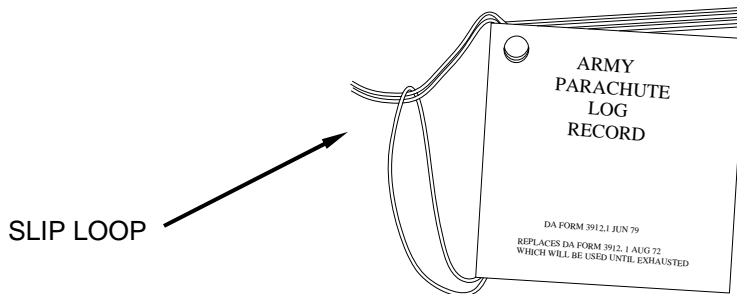

Figure 17. Forming Slip Loop on Log Record Outside.

3. Pass the lacing length running ends through the corner attaching hole, from the front cover of the log record (Figure 18).

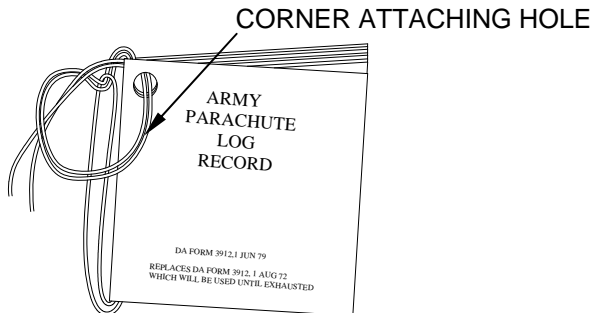

Figure 18. Passing Lacing Loose Ends through Corner Attaching Hole.

ASSEMBLY – CONTINUED

4. Ensure the running ends are routed over that part of the lacing length located along the log record centerfold (Figure 19).

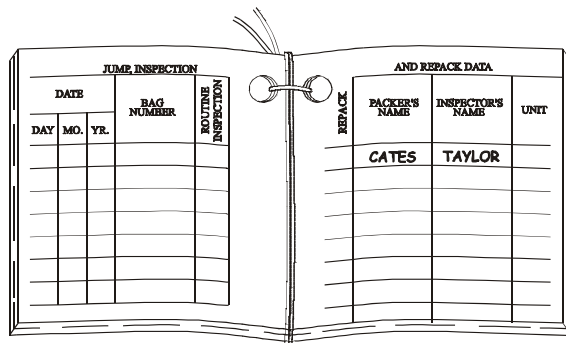

Figure 19. Routing Lacing Loose End through Log Record Centerfold.

5. Complete the attachment tie by making a half hitch on top of the slip loop made in step 2. (Figure 20).
6. Thread one running end of the log record attachment tie in an upholsterer's needle and pass the needle, with attached tie, through the edge binding of the applicable parachute log record/inspection data pocket.
7. Remove the lacing end from the upholsterer's needle and make a finished 10-inch long log record attaching loop by securing the two lacing ends together with an overhand knot.

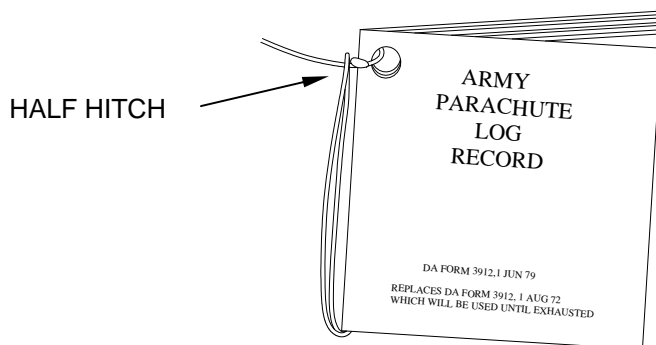

Figure 20. Log Record Attachment Tie Completed.

8. Insert the log record into the pocket.

END OF TASK

ASSEMBLY – CONTINUED**Attach Skirt Assist Lines****WARNING**

If the reserve canopy has been deployed in a known high-speed malfunction, the reserve canopy will be removed from service. Continued use may cause the canopy to fail resulting in serious injury or death to the parachutist.

WARNING

If the reserve canopy has been deployed for any reason, determine the reason for deployment. In any event, the skirt assist line attachment points shall be inspected to determine if the Type I, ¼-inch cotton webbing has broken. If any skirt assist lines are broken, and it has been determined the reserve canopy was NOT involved in a known high speed deployment, remove and replace the skirt assist ties with Type I, ¼-inch cotton webbing IAW WP 0058.

NOTE

Ensure that all skirt assist ties are secured properly.

Each suspension line is cascaded near the lower lateral band of the canopy. The continuous lines attach to the skirt and the cascaded lines are attached to loops on the corresponding seam 19½-inches on the inside of the canopy. The cascaded portions are called “Skirt Assist Lines” and aid in inflation of the canopy.

During high-speed deployments, the skirt assist lines break free of the canopy to dampen the opening shock. During low speed deployments, they remain attached and assist in the deployment. During normal repack, the skirt assist line attaching loop should be inspected but it is not necessary to replace them unless the canopy has been deployed or if ties are excessively worn.

1. Cut 20, 12-inch lengths of Type I, ¼-inch cotton webbing.
2. Release tension, if necessary, and start with line 1, follow the inside main seam until you run into the skirt assist line attaching loop (Figure 21, Item 1).

CAUTION

Ensure there are no twists or turns in the skirt assist lines.

NOTE

Inverting the canopy will aid in this process.

3. Route one end of a 12-inch length of Type I, ¼-inch, cotton webbing, one turn single, through one end of the skirt assist line attaching loop, through the looped end of the skirt assist line (Figure 21, Item 2), and back through skirt assist line attaching loop.

ASSEMBLY – CONTINUED

4. Draw tightly and secure the ends of the Type I, ¼-inch cotton webbing (Figure 21, Item 3), over the skirt assist line attaching loop (Figure 21, Item 1), with a surgeon's knot, locking knot.
5. Trim the excess to ½ inch.
6. Repeat steps 2 through 5 with the additional 19 skirt assist lines.
- 7.
8. Re-invert the canopy if inverted to aid in this procedure.

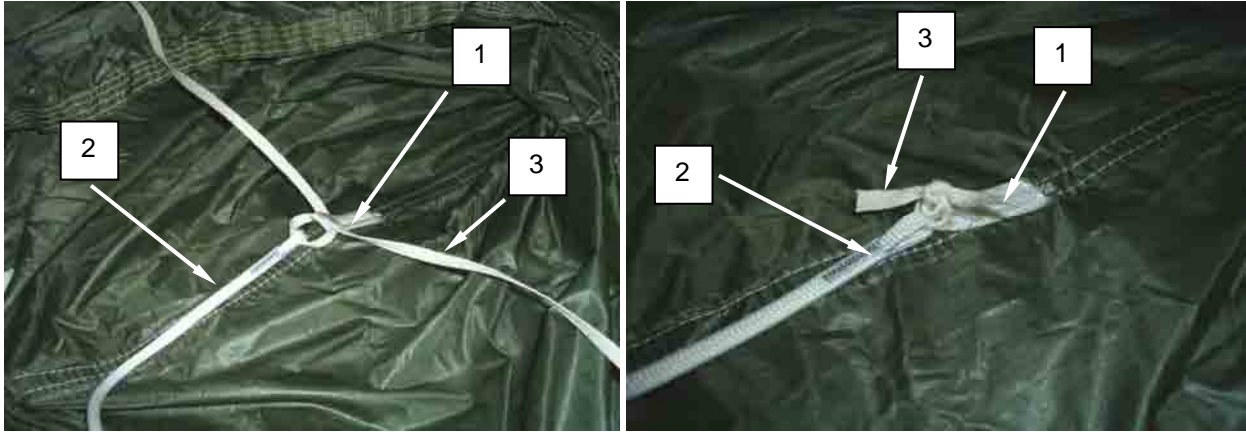

Figure 21. Attaching Skirt Assist Lines.

END OF TASK

ASSEMBLY – CONTINUED

Completing a Log Record Entry

Upon completion of the first technical/rigger-type inspection, the individual performing the inspection will initially prepare a log record for an individual parachute, or applicable type parachute harness assembly, and complete subsequent record entries using the following procedures:

NOTE

Log record entries will be made with a suitable type blue or black marking device that cannot be erased (no felt tip markers).

1. Inside Front Cover. Using the information provided on the parachute canopy data block, make the following entries on the inside front cover of the log record (Figure 22). Entries may be continued on the inside of the back cover, if necessary.

SERIAL NO.	○
TYPE	
PART NO.	
DATE OF MFG. (Month & Year)	
MANUFACTURER	
CANOPY CONTRACT NO.	
MO/YR CANOPY PLACED IN SERVICE	
STATION & UNIT	
<small>(Continued on inside back cover)</small>	

Figure 22. Inside Front Cover

NOTE

A parachute canopy serial number is recorded in a log record as a method of establishing control for maintenance, Equipment Improvement Report (EIR) and Product Quality Deficiency Report (PQDR) documentation, and to ensure the correct original record is reattached should the record become detached.

- a. Serial Number. Enter the parachute canopy assembly serial number.
- b. Type. Enter the parachute type.
- c. Part number. Enter the part number of the parachute canopy.
- d. Date of Manufacture. Enter the month and year the parachute canopy was manufactured.
- e. Manufacturer. Enter the name of the parachute canopy manufacturer.
- f. Canopy Contract Number. Enter the entire contract number specified for the parachute canopy.
- g. Mo/Yr Canopy Placed in Service. Enter the month and year that the canopy was placed in service.
- h. Station and Unit. Enter the name of the station and unit to which the parachute canopy is currently assigned. When a parachute is transferred permanently to another station and/or unit, the original entry is lined out and the name of the receiving station, and/or unit, will be entered.

ASSEMBLY – CONTINUED

- 2. Inside Back Cover. Entries may be continued on the inside back cover, if necessary (Figure 23).

Figure 23. Inside Back Cover.

- 3. Modification Work Order (MWO) Compliance Record Page. When a modification is performed on a parachute canopy, the following entries will be made on the Modification Work Order Compliance Record pages of the log record, as follows:

- a. MWO Number. Enter the MWO number and date of the MWO (Figure 24).

MODIFICATION WORK ORDER		COMPLIANCE RECORD					
MWO NUMBER	MWO TITLE	MODIFIED BY (NAME)	INSP. BY	UNIT	DATE		
					DAY	MONTH	YEAR
10-1670-292-20-1	Steering Orifice	Unknown	Hancock	SBCCOM	10	10	1992
10-1670-292-20-2	D-ring Replacement	Carver	Brown	SBCCOM	7	12	1996

Legend

- 1. Modification Completed by Unknown Due to Lost Original Log Record
- 2. Modification Work Order Compliance Completed

Figure 24. Modification Work Order (MWO) Compliance Record Page.

- b. MWO Title. Enter a short, abbreviated title extracted from the MWO prescribing the work.
- c. Modified by. Enter the last name of the individual who has performed the modification. If the original log record for the parachute has been lost, and it has been determined through inspection that a particular modification has been completed, the entry for this column will be C/W, complied with, which signifies the applicable MWO has been complied with.
- d. Inspected by. The individual who performed the inspection, required after modification, will sign this entry with last name only.
- e. Unit. Enter the unit designation responsible for performing the MWO or, in the event of a lost log record, the unit to which the inspector is assigned.
- f. Date. Enter the day, month, and year the modification work was completed.

ASSEMBLY – CONTINUED

4. Unit Repair and Inspection Data. When a parachute canopy assembly is initially received from a supply source, and a technical/rigger-type inspection is performed, the inspection performed will be documented on the Unit Repair and Inspection Data page of the individual parachute log record. Additional entries will also be made on this page each time the canopy assembly is repaired, or is administered an inspection, in compliance with a Safety of Use Message (SOUM), Ground Precautionary Message (GPM) or a Maintenance Advisory Message (MAM). The page completion criteria are as follows (Figure 25):

UNIT & INTERMEDIATE		REPAIR & INSPECTION DATA			
TYPE OF REPAIR	INSP BY	UNIT	DATE		
			DAY	MONTH	YEAR
1 → Initial Inspection	Phillips	SBCCOM	12	2	01
2 → ISEC and 4 lines replaced	Kididis	SBCCOM	3	3	01
3 → TB10-1670-213-2015	Land	SBCCOM	10	4	01

- Legend**
- 1. Completion of Initial Inspection
 - 2. Repair Performed
 - 3. SOUM, GPM, or MAM Inspection Compliance

Figure 25. Unit Repair and Inspection Data.

- a. Type of repair. Enter the type of repair, completion of initial inspection, SOUM, GPM, or MAM inspection compliance.
- b. Inspection by. The individual, who performed the inspection required, will sign this entry with last name.
- c. Unit. Enter the unit designation responsible for performing the type of repair.
- d. Date. Enter the day, month, and year the repair was performed.

ASSEMBLY – CONTINUED

5. Notes page. A page is provided at the back of a parachute log record to accommodate recording additional data pertinent to the serviceability of a parachute canopy assembly. This shall also include the month and year the item was placed in service (Figure 26).

NOTES
<p>○</p> <p>Riser Mfg Date: Jan '86 Placed in Service: Mar '86 Immersed in Saltwater: 26/10/86 Rinsed: 27/10/86</p>

Figure 26. Notes Page.

NOTE

A parachute log record that is completely filled out, lost, illegible, or otherwise in an unserviceable condition, will be replaced with a serviceable log record. Local population sheets should be used to record all maintenance work orders (MWO's) performed on the system for historical data.

6. Replacing a filled out or unserviceable log record.
 - a. Using a suitable blue or black marking device, enter NEW BOOK on the outside front cover of the replacement log record.
 - b. Transcribe the information from the inside front cover of the original log record to the inside front cover of the replacement log record. If the original data is illegible or missing, use the canopy information data block to collect the required data.
 - c. In the replacement log record, transcribe the initial and last entry made on the Jump, Inspection, and Repack Data page of the original log record.
 - d. Transcribe all data from the remaining pages of the original log record to the appropriate pages of the replacement log record.
 - e. After all original data has been transcribed, file the original log record for historical purposes.
7. Replacing a lost log record.

NOTE

Any time a log record is discovered missing from a parachute; a replacement log record will be initiated during repack or inspection, as applicable.

- a. Complete the log record inside front cover as prescribed above.
- b. If it can be ascertained by inspection that a previous MWO, SOUM, GPM, or MAM has been complied with, applicable entries will be made on the appropriate page of the replacement log record.

ASSEMBLY – CONTINUED

- c. Attach the replacement log record to the log record/inspection data pocket using the procedures above.

END OF TASK

END OF WORK PACKAGE

FIELD MAINTENANCE
SHAKEOUT AND AIRING
SERVICE

INITIAL SETUP:**Tools and Special Tools**

Brush, Scrub (WP 0102, Item 6)
Kit Bag, Flyer's (WP 0102, Item 24)

Personnel Required

Two, MOS Non-specific

Materials/Parts

None required

References

None required

Equipment Condition

Unpacked

SERVICE**Shakeout**

A two-person team, either indoors within a shakeout room or outdoors at a shakeout tower, will perform the shakeout. Suspend each parachute by the canopy apex and remove all debris by shaking the canopy thoroughly or by brushing with a dry, soft-bristled brush as detailed below:

1. With assistance from the No. 2 person, the No. 1 person will connect the snap (Figure 1, Item 1) on a pulley rope to the canopy bridle loop (Figure 1, Item 2).

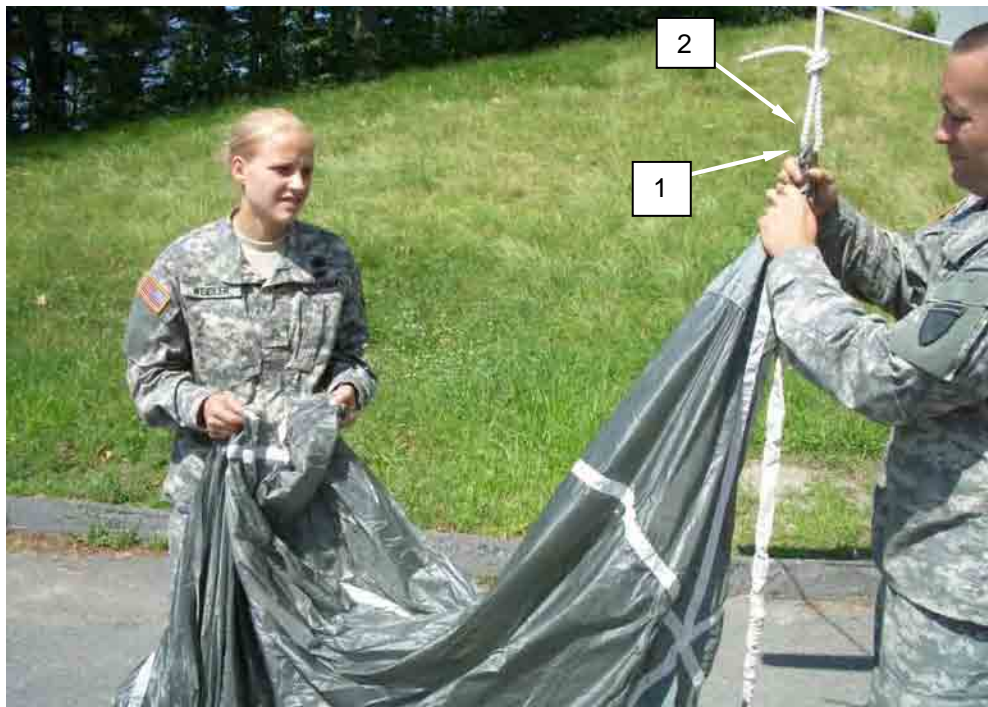

Figure 1. Connecting Snap on Pulley Rope to Canopy Bridle Loop.

SERVICE - CONTINUED

2. Through use of the pulley rope, the No. 2 person will raise the canopy to a suitable height; this will enable the No. 1 person to perform shakeout on each of the canopy panels. Until the panel shaking process is completed, the No. 2 person will maintain a steady pull on the pulley rope to hold the suspended canopy at the working height needed by the No. 1 person.
3. The No. 1 person will grasp any two-consecutive suspension lines (Figure 2, Item 1), one in each hand, and vigorously shake the first panel (Figure 2, Item 2).



Figure 2. Grasping Two Consecutive Suspension Lines and Shaking First Panel.

SERVICE - CONTINUED

4. When the panel is free of debris, the No. 1 person passes the line from the right hand to the left hand and grasps the next consecutive suspension line, in the right hand. The No. 1 person will shake out each consecutive panel until all suspension lines are held in the left hand, and all panels are free of debris.
5. Once the panel shaking process is completed, the No. 2 person will slowly raise the suspended canopy higher as the No. 1 person clears the suspension lines of debris and removes entanglements (Figure 3, Item 1), when possible.



Figure 3. Clearing Suspension Lines of Debris and Removing Entanglements.

SERVICE - CONTINUED

6. After the suspension lines have been cleared, the No. 2 person may hold, or temporarily secure, the pulley rope while the No. 1 person proceeds to clear debris from other parachute components such as the risers, harness assembly, and pack tray.
7. When all components are free of debris, the No. 2 person will slowly lower the canopy, while the No. 1 person S-folds the suspension lines (Figure 4, Item 1) into the aviator's kit bag (Figure 4, Item 2).



Figure 4. S-Folding Suspension Lines into Aviator's Kit Bag.

8. After the suspension lines have been completely S-folded, the No. 1 person will accordion-fold the canopy length on top of the folded lines.
9. As the canopy folding is being completed, the No. 1 person disconnects the canopy vent from the pulley rope snap. Secure the folded canopy assembly for further handling.

END OF TASK**Airing**

Where dampness and mildew are prevalent, air delivery equipment will be aired at frequent intervals according to the severity of the prevailing conditions. Parachutes that have been previously packed or are unpacked, and have been subjected to conditions of dampness or mildew, will be aired for a period of at least 6 hours prior to being repacked. Air delivery items may be aired either indoors or outdoors in dry weather. However, fabric items will not be aired in direct sunlight. Airing may be accomplished by suspending or elevating the applicable item(s) in a manner that would allow maximum exposure to air circulation. Outside facilities used for the shakeout of parachutes may be used for the airing of air delivery equipment if weather conditions permit. If the shakeout facilities are inadequate for airing, the applicable item(s) may be suspended or elevated at several points, or draped over suitable type objects that will not cause damage.

END OF TASK**END OF WORK PACKAGE**

FIELD MAINTENANCE**CLEANING AND DRYING
SERVICE****INITIAL SETUP:****Tools and Special Tools**

Brush, Scrub (WP 0102, Item 6)
File, Hand, Flat (WP 0102, Item 16)

Personnel Required

Parachute Rigger 92R1P (1)

Materials/Parts

Cloth, Abrasive (WP 0101, Item 10)
Dishwashing Compound (WP 0101, Item 19)
Rag, Wiping (WP 0101, Item 33)

References

WP 0100

Equipment Condition

Unpacked

SERVICE**Cleaning and Drying****CAUTION**

If, during the cleaning, there is a possibility that the substance to be removed contains acid or some other equally destructive ingredient, the item will be sent to the maintenance section for determination as to the nature of the substance and item disposition. If the substance cannot be identified, or if normal repair procedures will not eliminate all traces of chemical or acid damage, the applicable item will be condemned.

NOTE

Cleaning of parachutes should be held to a minimum and should be performed only when necessary, to prevent malfunction or deterioration. When a parachute contains debris, or when it is soiled by dirt, oil, grease, rust, corrosion, or other foreign substances, to such an extent that cleaning is necessary, the cleaning should be performed manually and should be limited to the soiled area only, unless the parachute has been contaminated by water. The methods of cleaning must be determined by the nature of the substance to be removed. Do not use cleaning solvent to clean items soiled by airsickness. Use a solution of hand dishwashing compound to clean this type of soiling.

The following ties need to be replaced if reserve parachute is submerged in salt water: skirt assist ties, drogue attachment ties, and reserve closing loop.

Cleaning Fabric Items with a Solution of Hand Dishwashing Compound

1. Gently brush with a soft bristle brush.
2. Spot clean with a solution of dishwashing compound.
 - a. Dissolve ½-cup of dishwashing compound in one gallon of warm water.
 - b. Rub the soiled area with a clean cloth dampened with a solution of dishwashing compound.

SERVICE - CONTINUED

- c. Rinse the cleaned area by repeating the rubbing process, with a clean portion of the cloth dampened with water.

END OF TASK**Rinsing Parachute Assembly Immersed in Saltwater**

If the parachute, or any of its components, has been immersed in salt water in excess of 24 hours it will be condemned. Additionally, if the parachute, or any of its components, has been immersed in salt water for a period less than 24 hours, but cannot be rinsed within 48 hours after recovery, it will also be condemned unless the following actions are performed. Upon removal from the salt water, the parachute is placed in a single, heavy duty plastic, trash bag; the top of the bag secured closed and kept in a wet state until a rinse can be performed following normal rinse procedures. The bag must be doubled when outside temperatures exceed 85 °F (29 °C). The bags must be inspected after transport and storage to ensure the bag did not get torn and the assembly was allowed to dry. Parachutes recovered using this method must be rinsed no later than 7 days after the salt water immersion or be condemned. However, if the cited time limitations can be met, then immediately upon recover suspend or elevate the parachute assembly in a shaded area and allow it to drain for at least 5 minutes. Do not attempt to wring the fabric or the suspension lines. Within 48 hours after recover under the supervision of a qualified parachute rigger (92R), rinse the recovered parachute assembly as follows:

1. Place the parachute assembly in a large watertight container filled with a suitable amount of fresh, clean water to cover the assembly.

NOTE

If the salt-water-soaked parachute assembly is too large to be placed into a rinsing container, then the rinsing process will be accomplished by applying fresh clean water to the assembly using a hose.

2. Agitate the container contents by hand for 5 minutes.
3. Remove the parachute assembly from the container and suspend or elevate it in a shaded area, allowing a 5-minute drainage period. Do not attempt to wring the fabric or the suspension lines.
4. Repeat the procedures in steps 1 through 3 above, twice, using fresh clean water for each rinse.
5. After the third rinse, allow the parachute assembly to drain thoroughly. Upon completion of draining, dry the assembly in accordance with the DRYING FABRIC ITEMS procedures, below.
6. When dried, perform a technical/rigger-type inspection of the parachute assembly. Corroded metal components, or corrosion-stained fabrics or suspension lines, will be either repaired or replaced as prescribed by the Maintenance Allocation Chart (MAC) in WP 0100.
7. Record any repair, immersion, and rinsing in the parachute log record.

END OF TASK

SERVICE - CONTINUED**Rinsing Parachute Assembly Immersed in Fresh Water**

Any parachute, or its components, that has been immersed in a fresh water lake, river, or stream will not require rinsing unless it has been ascertained that the water is dirty, oily, or otherwise contaminated. Procedures for handling a fresh water immersed parachute are as follows:

Contaminated Fresh Water. If the parachute, or its components, has been immersed in contaminated fresh water, rinse and dry (see RINSING PARACHUTE ASSEMBLY IMMERSSED IN SALT WATER, above), and, if applicable, repair.

Uncontaminated Fresh Water. If the parachute, or its components, has been immersed in uncontaminated fresh water, it will be cleaned and dried as outlined in CLEANING FABRIC ITEMS WITH A SOLUTION OF HAND DISHWASHING COMPOUND, DRYING FABRIC ITEMS, and CLEANING METAL ITEMS, in the detailed paragraphs above and below. Minor discoloration of fabric items, resulting from immersion in uncontaminated fresh water, may occur.

END OF TASK**Drying Fabric Items.****NOTE**

Fabric items will not be dried in direct sunlight or by laying an item on the ground except in an emergency.

1. Suspend or elevate the item in a well-ventilated room or in a heated drying room away from direct sunlight.
2. Using electric circulating fans or suspending the assembly in a heated drying room may reduce drying time.
3. Do not use in a room where the temperature exceeds 160 °F (71 °C) nor dry the assembly for more than three consecutive hours at this temperature.

END OF TASK**Cleaning Metal Items.****CAUTION**

Use care not to damage the adjacent fabric materials.

1. Remove burrs, rough spots, rust, or corrosion from metal items by filing with a metal file, or by buffing and polishing with abrasive cloth.
2. Remove all oils and filings by brushing and cleansing with dishwashing compound. Allow to dry.

END OF TASK**END OF WORK PACKAGE**

FIELD MAINTENANCE

MAIN CANOPY
INSPECT**INITIAL SETUP:****Tools and Special Tools**

None required

Personnel RequiredParachute Rigger 92R1P (1)
Parachute Rigger 92R2P (1)**Materials/Parts**

None required

ReferencesAR 750-1
AR 750-32
DA FORM 3912
DA PAM 738-751
DA PAM 750-8
DA PAM 750-751
TB 43-0002-43
WP 0010**Equipment Condition**

Unpacked and Packed

INSPECT**Routine Inspection**

A routine inspection is a visual check performed to ascertain the serviceability of all visible components of a parachute that is packed or rigged for use. The inspection will be made on all components that can be inspected without opening the parachute pack. Prior to issue, a parachute rigger will administer this inspection. Personnel parachutes issued for an air delivery operation and not deployed will receive a routine inspection prior to being placed into ready-for-issue storage. Routine inspection will be recorded in the log record.

INSPECT – CONTINUED**Pack-In-Process Inspection**

A pack-in-process inspection is performed at specified intervals during the packing of a parachute to ensure that only authorized procedures and methods are being used. A parachute rigger other than the packer preparing the applicable equipment for use will accomplish the inspection. The intervals, at which the inspection is performed, are as follows:

WARNING

Deployment bag will be given a complete inspection, including static line and that portion of the static line that is covered by the static line sleeve. Failure to do so could result in serious injury or death to the parachutist.

NOTE

For Army personnel, the Pack-In-Process-Inspector (IP) qualifications are IAW AR 750-32.

In-process Rigger Checks- Main Parachute

1. After Proper Layout

- Inversion from canopy removed
- Suspension line turns, tangles, and twists removed
- Sleeve and sleeve organizer attached
- Harness assembly in proper layout
- Canopy release assemblies are properly closed and secured
- Bridle ring and packing loop tension device properly attached
- 4-Line check; Suspension Lines 1 and 28 (top inside), and lines 14 and 15 (bottom inside) clear

2. Orientation of Slider

- Alignment of grommets 1 and 3
- Legible data block
- Slider not inverted

3. After Panel Folding

- Slider properly positioned
- Slider is clear
- Panels folded
- Canopy subdivided

4. After Long Fold

- Right group folded
- Left over right group folded

5. After Packing Loop Tension Device Removed

- Sleeve pulled over canopy
- Packing loops removed from packing loop tension device (untangled)
- Packing loop tension device, packing loop and bridle ring removed/released

INSPECT – CONTINUED

6. After Bridle Line Stowed

- Center section fabric S-folded
- Reinforcement panel properly positioned

7. After Drogue Is Positioned In Deployment Bag

- Deployment sleeve properly closed. Hook and pile properly mated to top of sleeve with no fabric between hook and pile.
- Deployment bag attached to cradle
- Drogue parachute properly positioned

8. After 1st Regular Stow

- Canopy stowed
- First locking stow
- Second locking stow
- D-bag flattened
- First regular stow

9. After Connector Link Routed

- Slack in suspension line stows
- Stow loops approximately 1-1/2 to 2 inches in length
- Rolled stow loops
- Stow hooks removed
- Connector link ties routed and proper material
- Suspension lines not routed over barrel nuts

10. After Connector Links Tied

- Suspension lines not routed over barrel nuts
- Log record entry (D-bag number)

11. After Pack Closing

- Risers centered on pack harness assembly
- D-bag positioned
- Curved pin positioned
- Pack closing (Right, Left, Lower, Upper)

12. Completion of Pack

- Pull up cord removed
- Pack dressed
- Static line stowed
- Entries in log record completed

END OF TASK

INSPECT – CONTINUED**Technical/Rigger-Type Inspection Procedures**

Overall Inspection. An overall inspection will be made on the T-11 Personnel Parachute System as follows:

1. Log record/parachute inspection data pocket and form. As applicable, inspect the assembly log record parachute inspection data pocket to ensure the Army Parachute Log Record (DA Form 3912) is enclosed and properly attached. Further, remove the log record from the pocket and evaluate the recorded entries. Inspect and evaluate as follows:

The Army Parachute Log Record, DA Form 3912, and AFTO 391 are history-type maintenance documents that accompany the parachute canopy and pack tray assemblies through the period of service of the individual assembly. The log record provides a means of recording maintenance actions performed on a parachute canopy assembly. Normally, a log record is initiated and attached upon receipt by a using unit. However, if the item is subjected to alteration or modification by a maintenance activity during the interim period from date of manufacture to receipt by a using unit, the log record will be prepared by the activity performing the maintenance function. Once initiated, a log record will be attached to, and contained in, an affixed parachute log record/inspection data pocket, until such time as the parachute canopy assembly is destroyed or rendered unfit for further use or repair. Additionally, should an item that requires a log record be transferred from one unit to another, the log record for the parachute assembly will accompany the item in the transfer action. A prepared log record will not be removed or separated from a parachute, and especially a packed parachute, except as directed by the local Airdrop Systems Technician (921A) or Senior Airdrop NCO (92R4P) and above, under guidance from an Airdrop Systems Technician assigned to the command at the Battalion level or higher, when no Airdrop Technician is assigned at the Company/Detachment/Team level. A log record that is illegible, lost, damaged, soiled, or precludes further entries due to lack of space, will be replaced upon the next repack or inspection, as applicable, with a serviceable item from stock.

2. Assembly completeness. Ensure the applicable assembly is complete and that no components (or parts) are missing.
3. Operation adequacy. Check each assembly and components to ensure proper assembly, which includes attachment and alignment, and that the assembled product functions in the prescribed manner. Further, ensure that no stitch formation (or sewn seam) has been omitted.
4. Markings and stenciling. Check each assembly and components for faded, illegible, obliterated, or missing informational data and identification numbers.
5. Foreign material and stains. Check each assembly and components for the presence of dirt or similar type foreign material. Also check for evidence of mildew, moisture, oil, grease, pitch, resin, contamination by salt water, or bodily fluids.

END OF TASK

INSPECT – CONTINUED

Detailed Inspection. In addition to the overall inspection performed in the overall inspection, a detailed inspection will be performed on the materials that constitute the assembly or component construction using the following criteria, as applicable:

1. Metal. Inspect for rust, corrosion, dents, bends, breaks, burrs, rough spots, sharp edges, wear, deterioration; damaged, loose or missing grommets, connector snap, loss of spring tension; and missing or loose screws.
2. Cloth. Inspect for breaks, burns, cuts, frays, holes, rips, snags, tears; loose, missing, or broken stitching or tacking; and weak spots, wear, or deterioration.
3. Fabric tape, webbing, and cordage. Inspect for breaks, burns, cuts, frays, holes, snags, tears, incorrect weaving, and sharp edges formed from searing; loose, missing, or broken stitching, tacking, whipping, and weaving; weak spots, wear, and deterioration.

END OF TASK

In-Storage Inspection

An in-storage inspection is a physical check conducted on a random sample of air delivery equipment that is located in storage. The purpose of the inspection is to ensure that the equipment is ready for issue, that the item is properly identified and segregated from other types of equipment, that no damage or deterioration of equipment has been incurred, and that all modifications or similar action requirements have been completed. The inspection shall also concern the methods and procedures applied to the storage of air delivery items, the adequacy of storage facilities, efforts of pest and rodent control, and protection against unfavorable climatic conditions. Air delivery equipment that is in storage will be inspected at least semiannually and at more frequent intervals if prescribed by the by the local Airdrop Systems Technician (921A) or Senior Airdrop NCO (92R4P) and above, under guidance from an Airdrop Systems Technician assigned to the command at the Battalion level or higher, when no Airdrop Technician is assigned at the Company/Detachment/Team level. The frequency of inspection may vary according to the type of storage facilities and local climatic conditions. Only parachute rigger personnel designated by the local parachute maintenance officer will conduct in-storage inspections.

Equipment Disposition

Air delivery equipment may be rendered unserviceable by either normal fair wear or by aging, and will subsequently be repaired, modified, or condemned, as appropriate. Equipment that is uneconomically repairable (outdated) will be condemned. Disposition of air delivery equipment that is condemned, unserviceable, or for which the serviceability is questionable, will be accomplished using the following procedures, as applicable:

Item Requiring Repair or Modification. An air delivery item that requires repair or modification will be tagged in accordance with DA PAM 738-751. Subsequent work on the item will be performed at the maintenance level specified for the maintenance function in the applicable supporting technical publication.

Parachutes with Exhausted Age or Service Life. Any parachute component or air delivery equipment whose age or service life has expired as specified in TB 43-0002-43 will be removed from service, condemned and tagged as prescribed by DA PAM 738-751.

Disposition of Condemned Air Delivery Equipment. Condemned equipment, other than fatality parachutes, will be removed from service and disposed of in accordance with local standing operating procedures. Condemned equipment due to a fatality will be disposed of IAW local standard operating procedures.

INSPECT – CONTINUED

Unserviceable Equipment. Equipment, which prior to initial use, is deemed unserviceable for use will be reported in a PQDR in accordance with DA PAM 750-8, as authorized by AR 750-1. Each applicable item that is unserviceable will be held and safeguarded pending receipt of disposition instructions from the National Maintenance Point (NMP). In all instances, PQDR exhibit material will be handled as prescribed in DA PAM 750-8. If the quality or the serviceability of an item is questionable, clarification and assistance may be obtained by contacting Commander, U.S. Army TACOM Life Cycle Management Command, ATTN: AMSTA-LC-LMPP/TECH PUBS, 1 Rock Island Arsenal, Rock Island, IL 61299-7630.

Equipment of Doubtful Serviceability. Equipment that has had previous use and has not exceeded normal fair wear or aging criteria, but of which further serviceability is doubtful, will be tagged as prescribed in DA PAM 750-751. In addition, the equipment will be reported in a PQDR, in accordance with DA PAM 750-8 and AR 750-1. The item(s) in question will be held as PQDR exhibit material as outlined in DA PAM 750-8 pending receipt of disposition instructions from the National Maintenance Point (NMP). A maintenance activity holding PQDR exhibit material will not tamper with the applicable item(s) or make any attempt to ascertain cause factors. Unnecessary handling of PQDR exhibit material may disturb or alter peculiar aspects of the affected item(s) that might affect the judgment of engineering personnel who have the responsibility for final evaluation of PQDR actions.

Equipment Immersed in Salt Water. Any air delivery item constructed from cotton material that has been immersed in salt water will be condemned. Cotton thread used for tacking and sewing on nylon parachute packs that have been immersed in salt water will only be replaced when there is visible evidence or deterioration such as extreme discoloration or indications of broken thread. Any air delivery equipment constructed of nylon or rayon material that has been immersed in salt water for a period less than 24 hours, but which cannot be rinsed within 48 hours after recovery will also be condemned unless the following actions are performed. Upon removal from the salt water, the parachute is placed in a single, heavy duty plastic, trash bag; the top of the bag secured closed and kept in a wet state until a rinse can be performed following normal rinse procedures. The bag must be doubled when outside temperatures exceed 85 °F (30 °C). The bags must be inspected after transport and storage to insure the bag did not get torn and the assembly was allowed to dry. Parachutes recovered using this method must be rinsed NLT than 7 days after the salt water immersion or be condemned. However, if the cited time limitations can be met, then immediately upon recovery, suspend or elevate the recovered equipment in a shaded area and allow the item(s) to drain for at least 5 minutes. Do not attempt to wring the equipment fabric or the suspension lines. Within 48 hours after recovery, under the supervision of a qualified parachute rigger (92R), rinse the recovered equipment as indicated in WP 0010.

END OF TASK**END OF WORK PACKAGE**

FIELD MAINTENANCE**RESERVE CANOPY
INSPECT**

INITIAL SETUP:**References**

AFTO 391
AR 750-1
AR 750-32
DA Form 3912
DA PAM 738-751
DA PAM 750-8
DA PAM 750-751
TB 43-0002-43
WP 0010

Personnel Required

Parachute Rigger 92R1P (1)
Parachute Rigger 92R2P (1)

INSPECT**Routine Inspection**

A routine inspection is a visual check performed to ascertain the serviceability of all visible components of a parachute that is packed or rigged for use. The inspection will be made on all components that can be inspected without opening the parachute pack. Prior to issue, a parachute rigger will administer this inspection. Personnel parachutes issued for an air delivery operation and not deployed will receive a routine inspection prior to being placed into ready-for-issue storage. Routine inspection will be recorded in the log record.

Pack-In-Process Inspection**NOTE**

For Army personnel, the Pack-In-Process-Inspector (IP) qualifications are IAW AR 750-32.

A pack-in-process inspection is performed at specified intervals during the packing of a parachute to ensure that only authorized procedures and methods are being used. A parachute rigger other than the packer preparing the applicable equipment for use will accomplish the inspection. The intervals, at which the inspection is performed, are as follows:

INSPECT - CONTINUED**In-process Rigger Checks – Reserve Parachute**

1. After Proper Layout
 - Packtray in proper layout (connector snaps even with bottom edge of pack tray)
 - Spreader bar securing ties are in place and are secure
 - Connector snap ties are secure and properly secured to pack tray
 - Excess spreader bar tie in place
 - Two riser stows
 - Barrel nut on connector links inside/tightened towards the pack tray to 50-inch pounds
 - 4 line check (1 - 20 top) (10 - 11 bottom)
 - All apex loops retained by tension device.
 - Apex tie pre-positioned
 - Skirts assist ties present
 - Ejector spring compressed; packing rod and temp pin routed properly
 - Extractor secured to extractor vent bridle attachment loops
2. After Gore Folding (Flat Fold)
 - First tension applied
 - Gores folded
 - Second tension applied
 - Canopy fine dressed
 - Skirt assist lines left/right groups in line separator, if applicable, suspension lines routed to the outside left/right
 - Air channel is clear; 20 is on top
 - Scoops are dressed and tied correctly
3. After Long Fold
 - 45 degree skirt left/right folded
 - Right group over left group 3 inches over air channel folded
 - Scoops long folded on apex
 - Extractor properly S-folded
4. After First Regular Stow
 - Risers completely stowed (top and bottom)
 - Note retainer bands between the first and second riser stows
 - Connector links in the middle of the pack tray
 - First stow to upper right, aligned with the edge of the pack tray
5. After Suspension Lines are Stowed and Apex Tie Secured
 - 12 stows on the pack tray, 6 on the left/right
 - 3 free stows utilizing 1 inch retainer bands, one on the left/right before last stow
 - 12 inches of suspension lines remaining
 - Apex tie secured
6. After Extractor Parachute Position
 - Ensure all canopy folds are correct
 - Ejector spring properly positioned
 - Pull up cords properly aligned
 - Extractor parachute properly positioned
7. After Temporary Closing
 - Extractor cap positioned
 - Side closing flaps correct (left/right)

INSPECT - CONTINUED

8. After Curved Pins Are Inserted
 - Packing rod removed
 - Left/right pack tray flaps tucked
 - Upper/lower closing flaps closed
 - Ripcord handle positioned correctly (right tuck tabs)
 - Curved pins properly routed (curve of upper and lower pin facing clockwise and counter-clockwise respectively)
9. Completion of Pack
 - Pull-up cords removed
 - Left tuck tab inserted
 - Top/bottom ripcord assembly tuck tabs inserted; pack tray dressed
 - Conduct ripcord handle pull test
 - Complete log record book entry

END OF TASK**Technical/Rigger-Type Inspection Procedures**

Overall Inspection. An overall inspection will be made on the T-11 Reserve as follows:

1. Log record/parachute inspection data pocket and form. As applicable, inspect the assembly log record parachute inspection data pocket to ensure the Army Parachute Log Record (DA Form 3912) is enclosed and properly attached. Further, remove the log record from the pocket and evaluate the recorded entries. Inspect and evaluate as follows:

The Army Parachute Log Record, DA Form 3912, and AFTO 391 are history-type maintenance documents that accompany the parachute canopy and pack tray assemblies through the period of service of the individual assembly. The log record provides a means of recording maintenance actions performed on a parachute canopy assembly. Normally, a log record is initiated and attached upon receipt by a using unit. However, if the item is subjected to alteration or modification by a maintenance activity during the interim period from date of manufacture to receipt by a using unit, the log record will be prepared by the activity performing the maintenance function. Once initiated, a log record will be attached to, and contained in, an affixed parachute log record/inspection data pocket, until such time as the parachute canopy assembly is destroyed or rendered unfit for further use or repair. Additionally, should an item that requires a log record be transferred from one unit to another, the log record for the parachute assembly will accompany the item in the transfer action. A prepared log record will not be removed or separated from a parachute, and especially a packed parachute, except as directed by the local Airdrop Systems Technician (921A) or Senior Airdrop NCO (92R4P) and above, under guidance from an Airdrop Systems Technician assigned to the command at the Battalion level or higher, when no Airdrop Technician is assigned at the Company/Detachment/Team level. A log record that is illegible, lost, damaged, soiled, or precludes further entries due to lack of space, will be replaced upon the next repack or inspection, as applicable, with a serviceable item from stock.

2. Assembly completeness. Ensure the applicable assembly is complete and that no components (or parts) are missing.

INSPECT – CONTINUED

3. Operation adequacy. Check each assembly and components to ensure proper assembly, which includes attachment and alignment, and that the assembled product functions in the prescribed manner. Further, ensure that no stitch formation (or sewn seam) has been omitted.
4. Markings and stenciling. Check each assembly and components for faded, illegible, obliterated, or missing informational data and identification numbers.
5. Foreign material and stains. Check each assembly and components for the presence of dirt or similar type foreign material. Also check for evidence of mildew, moisture, oil, grease, pitch, resin, contamination by salt water, or bodily fluids.

END OF TASK

Detailed Inspection. In addition to the overall inspection performed in 1 above, a detailed inspection will be performed on the materials that constitute the assembly or component construction using the following criteria, as applicable:

1. Metal. Inspect for rust, corrosion, dents, bends, breaks, burrs, rough spots, sharp edges, wear, deterioration; damaged, loose or missing grommets, safety pins, connector snap, eye hook, pack fastener, improper swaging or welding, loss of spring tension; and missing or loose screws.
2. Cloth. Inspect for breaks, burns, cuts, frays, holes, rips, snags, tears; loose, missing, or broken stitching or tacking; and weak spots, wear, or deterioration.
3. Fabric tape, webbing, and cordage. Inspect for breaks, burns, cuts, frays, holes, snags, tears, incorrect weaving, and sharp edges formed from searing; loose, missing, or broken stitching, tacking, whipping, and weaving; weak spots, wear, and deterioration.

END OF TASK**In-Storage Inspection**

An in-storage inspection is a physical check conducted on a random sample of air delivery equipment that is located in storage. The purpose of the inspection is to ensure that the equipment is ready for issue, that the item is properly identified and segregated from other types of equipment, that no damage or deterioration of equipment has been incurred, and that all modifications or similar action requirements have been completed. The inspection shall also concern the methods and procedures applied to the storage of air delivery items, the adequacy of storage facilities, efforts of pest and rodent control, and protection against unfavorable climatic conditions. Air delivery equipment that is in storage will be inspected at least semiannually and at more frequent intervals if prescribed by the local parachute maintenance officer. The frequency of inspection may vary according to the type of storage facilities and local climatic conditions. Only parachute rigger personnel designated by the local parachute maintenance officer will conduct in-storage inspections.

Equipment Disposition

Air delivery equipment may be rendered unserviceable by either normal fair wear or by aging, and will be subsequently repaired, modified, or condemned, as appropriate. Equipment that is beyond economical repair or outdated will be condemned. Disposition of air delivery equipment that is condemned, unserviceable, or for which the serviceability is questionable, will be accomplished using the following procedures, as applicable:

Item Requiring Repair or Modification. An air delivery item that requires repair or modification will be tagged in accordance with DA PAM 738-751. Subsequent work on the item will be performed at the maintenance level specified for the maintenance function in the applicable supporting technical publication.

INSPECT – CONTINUED

Parachutes with Exhausted Age or Service Life. Any parachute component or air delivery equipment whose age or service life has expired as specified in TB 43-0002-43 will be removed from service, condemned, and tagged as prescribed by DA PAM 738-751.

Disposition of Condemned Air Delivery Equipment. Condemned equipment, other than fatality parachutes, will be removed from service and disposed of in accordance with current directives listed in this WP.

Rejected Equipment. Equipment, which prior to use, is deemed unserviceable for use will be reported in an EIR in accordance with DA PAM 750-8, as authorized by AR 750-1. Each applicable item that is defective will be held and safeguarded pending receipt of disposition instructions from national maintenance point. In all instances, EIR exhibit material will be handled as prescribed in DA PAM 750-8. If the quality or the serviceability of an item is questionable, clarification and assistance may be obtained by contacting Commander, U.S. Army Tank-automotive and Armament Command, ATTN: AMSTA-LC-SECT, 15 Kansas Street, Natick, MA 01760-5052.

Unserviceable Equipment. Equipment, which prior to initial use, is deemed unserviceable for use will be reported in a PQDR, in accordance with DA PAM 750-8 and AR 750-1. Each applicable item that is unserviceable will be held and safeguarded pending receipt of disposition instructions from national maintenance point. In all instances, PQDR exhibit material will be handled as prescribed in DA PAM 750-8. If the quality or the serviceability of an item is questionable, clarification and assistance may be obtained by contacting Commander, U.S. Army TACOM Life Cycle Management Command, ATTN: AMSTA-LC-LMPP/TECH PUBS, 1 Rock Island Arsenal, Rock Island, IL 61299-7630. You may also send in your recommended changes via electronic mail or by fax. Our fax number is DSN 793-0726 and commercial number (309) 782-0726. Our e-mail address is TACOMLCMC.DAForm2028@us.army.mil. A reply will be furnished to you.

Equipment of Doubtful Serviceability. Equipment that has had previous use and has not exceeded normal fair wear or aging criteria, but of which further serviceability is doubtful, will be tagged as prescribed in DA PAM 750-751. In addition, the equipment will be reported in a PQDR, in accordance with DA PAM 750-8 and AR 750-1. The item(s) in question will be held as PQDR exhibit material as outlined in DA PAM 750-8 pending receipt of disposition instructions from the NMP. A maintenance activity holding PQDR exhibit material will not tamper with the applicable item(s) or make any attempt to ascertain cause factors. Unnecessary handling of PQDR exhibit material may disturb or alter peculiar aspects of the affected item(s) that might affect the judgment of engineering personnel who have the responsibility for final evaluation of PQDR actions.

Equipment Immersed in Salt-Water. Any air delivery item constructed from cotton material that has been immersed in salt-water will be condemned. Cotton thread used for tacking and sewing on nylon parachute packs that have been immersed in salt-water will only be replaced when there is visible evidence or deterioration such as extreme discoloration or indications of broken thread. Any air delivery equipment constructed of nylon or rayon material that has been immersed in salt-water for a period less than 24 hours, but which cannot be rinsed within 48 hours after recovery will also be condemned unless the following actions are performed. Upon removal from the salt water, the parachute is placed in a single, heavy duty plastic, trash bag; the top of the bag secured closed and kept in a wet state until a rinse can be performed following normal rinse procedures. The bag must be doubled when outside temperatures exceed 85 °F (30 °C). The bags must be inspected after transport and storage to insure the bag did not get torn and the assembly was allowed to dry. Parachutes recovered using this method must be rinsed NLT than 7 days after the salt water immersion or be condemned. However, if the cited time limitations can be met, then immediately upon recovery, suspend or elevate the recovered equipment in a shaded area and allow the item(s) to drain for at least 5 minutes. Do not attempt to wring the equipment fabric or the suspension lines. Within 48-hours after recovery, under the supervision of a qualified parachute rigger (92R), rinse the recovered equipment as indicated in WP 0010.

END OF TASK

END OF WORK PACKAGE

FIELD MAINTENANCE

T-11 PERSONNEL PARACHUTE SYSTEM
TEST**INITIAL SETUP:****Tools and Special Tools**

None required

Personnel Required

92R1P Parachute Rigger (1)

Materials/Parts

None required

References

WP 0006

WP 0100

Equipment Condition

Unpacked

TEST**Salt/Fresh Water Contamination Test**

Look for a white crystalline residue. If evidence of salt water/fresh water contamination is found, refer to the procedures detailed below:

Rinsing Parachute Assembly Immersed in Salt Water. If the parachute, or any of its components, has been immersed in salt water in excess of 24 hours it will be condemned. Additionally, if the parachute, or any of its components, has been immersed in salt water for a period less than 24 hours, but cannot be rinsed within 48 hours after recovery, it will also be condemned unless the following actions are performed. Upon removal from the salt water, the parachute is placed in a single, heavy duty plastic, trash bag; the top of the bag secured closed and kept in a wet state until a rinse can be performed following normal rinse procedures. The bag must be doubled when outside temperatures exceed 85°F. The bags must be inspected after transport and storage to ensure the bag did not get torn and the assembly was allowed to dry. Parachutes recovered using this method must be rinsed NLT than 7 days after the salt water immersion or be condemned. However, if the cited time limitations can be met, then immediately upon recovery suspend or elevate the parachute assembly in a shaded area and allow it to drain for at least 5 minutes. Do not attempt to wring the fabric or the suspension lines. Within 48 hours after recovery under the supervision of a qualified parachute rigger (92R), rinse the recovered parachute assembly as follows:

1. Place the parachute assembly in a large watertight container filled with a suitable amount of fresh, clean water to cover the assembly.

NOTE

If the salt-water-soaked parachute assembly is too large to be placed into a rinsing container, then the rinsing process will be affected by applying fresh clean water to the assembly using a hose.

2. Agitate the container contents by hand for 5 minutes.
3. Remove the parachute assembly from the container and suspend or elevate it in a shaded area, allowing a 5 minute drainage period. Do not attempt to wring the fabric or the suspension lines.

TEST - CONTINUED

4. Repeat the procedures in steps 1 through 3 twice, using fresh clean water for each rinse.
5. After the third rinse, allow the parachute assembly to drain thoroughly. Upon completion of draining, dry the assembly in accordance with the Drying Fabric Items procedures detailed below.
6. When dried, perform a technical/rigger-type inspection of the parachute assembly. Corroded metal components, or corrosion-stained fabrics or suspension lines, will be either repaired or replaced as prescribed by the Maintenance Allocation Chart (MAC) in WP 0100.
7. Record the immersion and rinsing in the parachute log record as shown in WP 0006.

END OF TASK

Rinsing Parachute Assembly Immersed in Fresh-Water. Any parachute, or its components, that has been immersed in a fresh water lake, river, or stream will not require rinsing unless it has been ascertained that the water is dirty, oily, or otherwise contaminated. Procedures for handling a fresh water immersed parachute are as follows:

Contaminated Fresh Water. If the parachute, or its components, has been immersed in contaminated fresh water, rinse and dry (see Rinsing Parachute Assembly Immersed in Salt Water, above).

END OF TASK**NOTE**

Fabric items will not be dried in direct sunlight or by laying item on the ground.

Drying Fabric Items. Dry fabric items as follows:

1. Suspend or elevate the item in a well-ventilated room or in a heated drying room.
2. Using electric circulating fans may reduce drying time.
3. When heat is used, the heat temperature shall not exceed 160 °F (71 °C). The preferred temperature is 140 °F (60 °C).

END OF TASK**END OF WORK PACKAGE**

FIELD MAINTENANCE

PACKING MAIN PARACHUTE

INITIAL SETUP:**Tools and Special Tools**

Adapter, Tension Plate (WP 0102, Item 1)
 Cord, Pull Up, Closing (36 inches) (Type III, Nylon) (WP 0102, Item 10)
 Cradle, Deployment Bag Packing (WP 0102, Item 11)
 Hook, Parachute Packing (WP 0102, Item 21)
 Kit Bag, Flyer's (WP 0102, Item 24)
 Packing Loop, Tension Device (WP 0102, Item 33)
 Paddle, Parachute Packing (WP 0102, Item 35)
 Pin, Temporary Packing (WP 0102, Item 36)
 Plate, Tension, Parachute Packing (WP 0102, Item 37)
 Shears, Tailors, 12 Inch (WP 0102, Item 61)
 Sleeve Organizer, Deployment, T-11 Main (WP 0102, Item 62)
 T-bar, Packing (optional) (WP 0102, Item 66)
 Weight, Parachute Packing (WP 0102, Item 69)

Personnel Required

Parachute Rigger 92R1P (1)
 Parachute Rigger 92R2P (1)

References

AR 750-1
 AR 750-32
 DA PAM 738-751
 DA PAM 750-8
 DA PAM 750-751
 TB 43-0002-43
 WP 0007
 WP 0010
 WP 0011

Materials/Parts

Band, Rubber Parachute, 1-1/4-inch, 3/8-inch Wide (WP 0101, Item 2)
 Band, Rubber Parachute, 2-inches Long, 3/8-inch Wide (WP 0101, Item 3)
 Webbing, Textile, Cotton, Type 1, 1/4-inch Wide, Natural (WP 0101, Item 68)

Equipment Condition

Lay out on packing table or other suitable area.

PREPARING THE T-11 PERSONNEL PARACHUTE SYSTEM CANOPY FOR PROPER LAYOUT

This work package contains the packing procedures for the T-11 Personnel Parachute System Main Canopy.

Read all warnings and cautions within this section and follow procedures outlined herein to ensure safe operation of the T-11 Personnel Parachute System and associated equipment.

Pack-In-Process Inspection

A designated supervisory rigger, other than the packer, must perform a pack-in-process inspection at specified intervals during the packing procedure. The inspection is performed to ensure that the parachute is packed according to authorized packing procedures (refer to WP 0011).

PREPARING THE T-11 PERSONNEL PARACHUTE SYSTEM MAIN CANOPY FOR PROPER LAYOUT – CONTINUED

Orientation

Throughout this work package, all directions (right, left, upper, lower, top, bottom, clockwise, and counterclockwise) are given from the rigger’s point of view, as the rigger stands with the packing table to his left at the tension plate end of the packing table, facing the packing loop tension device end of the table. All directions are indicated as the parachute is in proper layout (Figure 1).

1. Top. That portion of the equipment that is farthest from the packing table surface.
2. Bottom. That portion of the equipment that is nearest to the packing table surface.

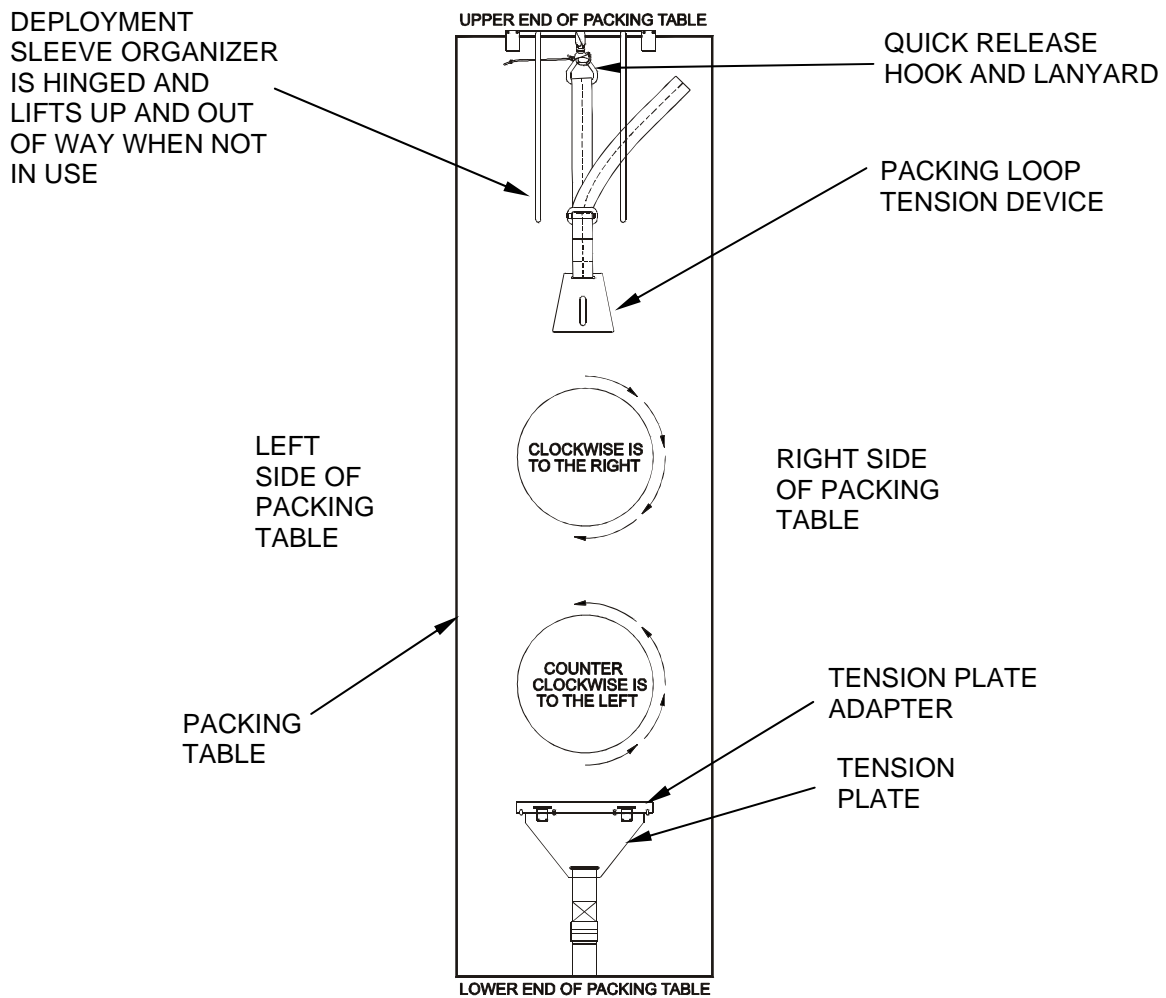

Figure 1. Rigger’s View.

PREPARING THE T-11 PERSONNEL PARACHUTE SYSTEM MAIN CANOPY FOR PROPER LAYOUT – CONTINUED

Layout the Canopy

1. Locate and attach the bridle ring to the quick release hook. If bridle ring cannot be located, the canopy may be inverted. Refer to the section that follows entitled “Removing Inversion”.
2. Extend the canopy along the length of the table with the connector links at the lower end of the packing table.
3. Locate a packing loop.
4. Clear the main seam all the way to the lower lateral band.
5. Follow the suspension line down. If there is canopy material wrapped around the suspension lines, there may be a partial inversion. Refer to section entitled “Removing a Partial Inversion”.
6. Check for turns, tangles, or twists. If no inversions or turns, tangles or twists are found proceed to section “Placing Deployment Sleeve on Sleeve Organizer”.

END OF TASK

Removing Inversion

1. Reach inside canopy from below lower lateral band.
2. Locate the drogue and deployment sleeve.
3. Pull deployment sleeve from inside canopy and locate bridle ring (Figure 2).



Figure 2. Removing an Inversion.

**PREPARING THE T-11 PERSONNEL PARACHUTE SYSTEM MAIN CANOPY FOR PROPER LAYOUT
– CONTINUED**

4. Pull the remainder of the canopy below the lower lateral band turning the canopy correct side out (Figure 3).
5. Attach the bridle ring to the quick release hook.



Figure 3. Passing the Bridle Ring down through Canopy.

END OF TASK**Removing a Partial Inversion**

1. To remove the partial inversion, wrap a packing weight around the suspension line.
2. Go to the lower end of the packing table and secure the riser assemblies with the left hand.
3. Carry the riser assemblies toward the upper end of the table to the lower lateral band.
4. With the right hand, trace the line secured with the packing weight through the canopy.
5. When the right hand clears the canopy material, drop the suspension line and transfer the riser assemblies from the left to the right hand.
6. With the left hand, grasp the canopy material that is now around the right arm.
7. Pull the riser assemblies, suspension lines, and slider up through the canopy material that is now on the right arm.
8. Return the riser assemblies to the lower end of the table and attach to the tension plate adapter.
9. Remove the packing weight from the suspension line.

END OF TASK

PREPARING THE T-11 PERSONNEL PARACHUTE SYSTEM MAIN CANOPY FOR PROPER LAYOUT – CONTINUED

Removing Turns/Tangles/Twists from Suspension Lines

Ensure that any inversion or partial inversion has been removed in accordance with the previous sections.

NOTE

Suspension lines 1 through 28 are divided into two groups, 1 through 14 are in the right group and 15 through 28 are in the left group.

1. Attach the riser assemblies to the inner hooks of the tension plate adapter with the male portion of the canopy release assemblies on both risers facing up (Figure 4).

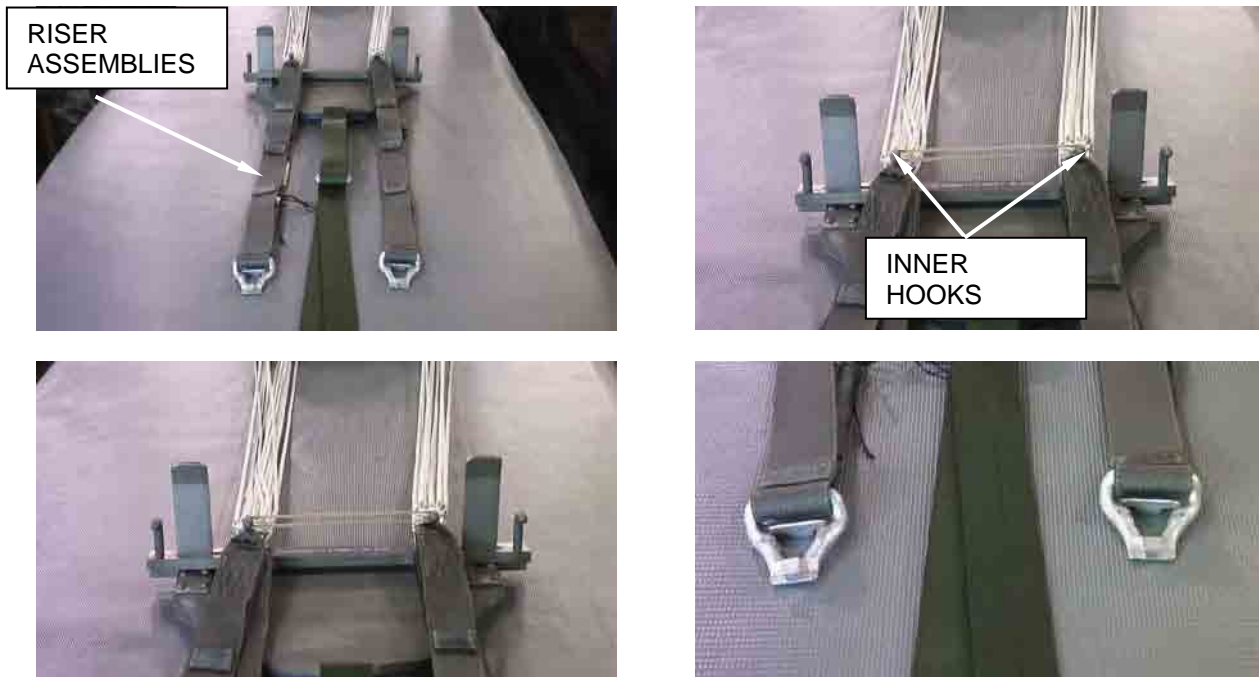

Figure 4. Attach the Riser Assemblies.

2. Find line 1 and following the lower lateral band to the right, count out 13 suspension lines, for a total of 14 suspension lines. This is the right suspension line group. The remaining lines are the left suspension line group.

NOTE

If turns, tangles, or twists are above the slider, work the turns, tangles, or twists down below the slider. There could be one to three reasons that turns, tangles, or twists are above the slider.

- The inversion may have been removed between two different suspension lines than the ones the canopy originally went through.
- The canopy may have been passed through the suspension lines between the slider and lower lateral band.
- The harness assembly may have passed through suspension lines between the slider and lower lateral band.

3. Place a packing weight around each suspension line group, at the lower lateral band above the slider, and move the packing weights toward the risers; remove turns, tangles and twists.

**PREPARING THE T-11 PERSONNEL PARACHUTE SYSTEM MAIN CANOPY FOR PROPER LAYOUT
– CONTINUED**

4. Remove turns, tangles and twists in accordance with the appropriate section in this work package.

END OF TASK

Turns. A turn occurs when one group of suspension lines rotates around the other group (Figure 5).

1. Remove the connector links from the tension plate adapter and remove a turn by rotating the risers or pack tray, in the direction opposite to the direction of the turn.
2. Reposition the connector links on the tension plate adapter.

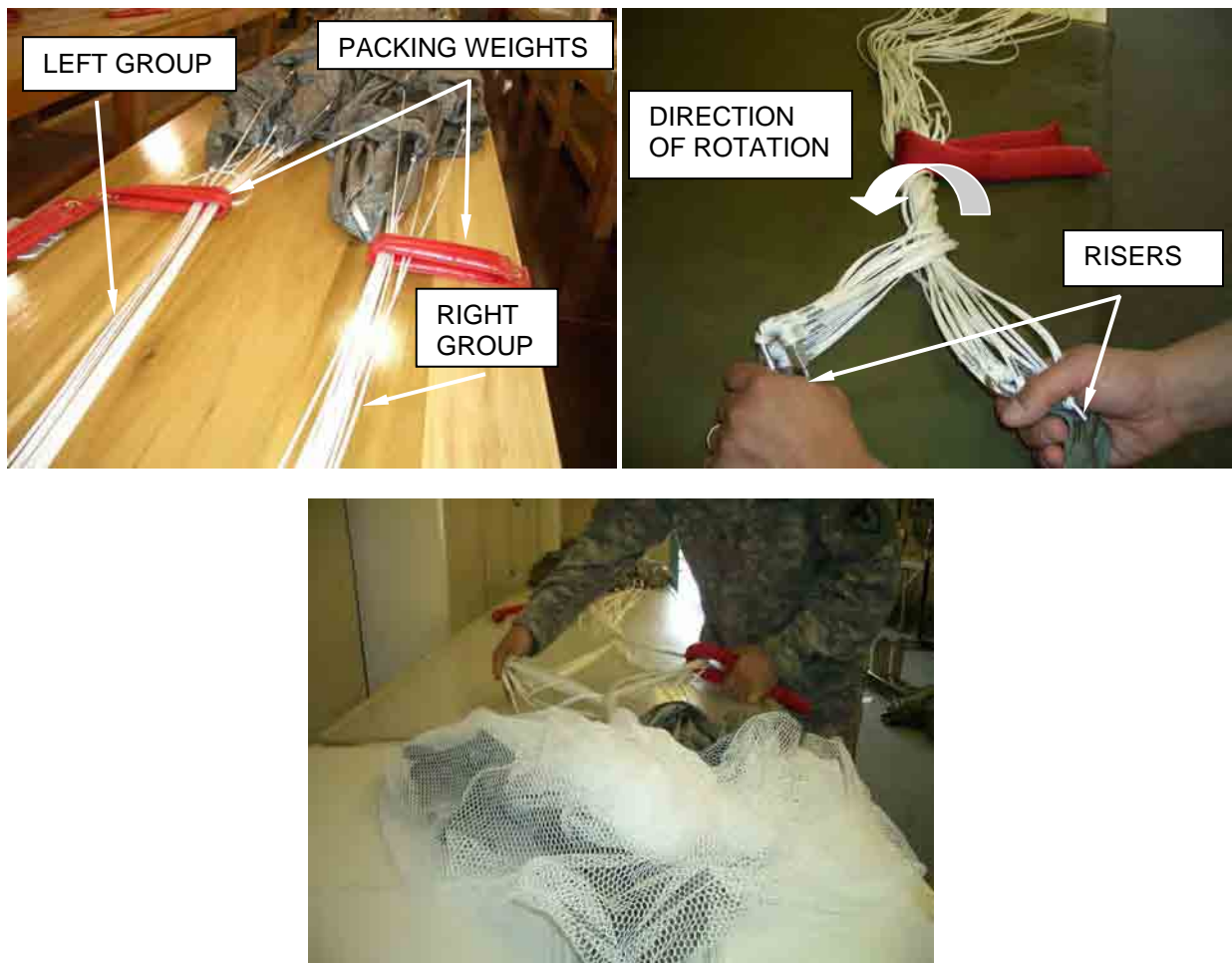

Figure 5. Removing Turns, Tangles, or Twists from Suspension Lines.

END OF TASK

**PREPARING THE T-11 PERSONNEL PARACHUTE SYSTEM MAIN CANOPY FOR PROPER LAYOUT
– CONTINUED**

Tangles. A tangle occurs when suspension lines from one group become improperly crossed with the other. To remove tangle(s), keep the two groups of lines separated and work tangles with the slider down the table as close to the risers as possible.

1. Achieve group separation above the slider first by passing the slider through the suspension lines with both sets of risers. Once group separation is achieved above the slider, achieve group separation below the slider by passing both sets of risers through the suspension lines below the slider. Select the top line(s) that form the tangle and, with the left hand, lift the line(s) away from the other lines (Figure 6).

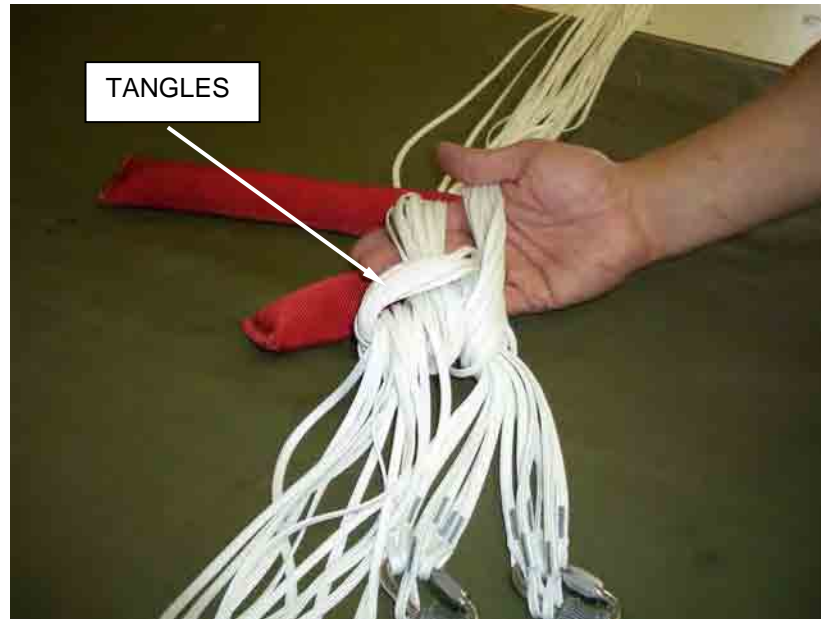

Figure 6. Lifting Lines from Other Lines.

2. Reach through the opening, created by lifting the suspension lines, with the right hand (Figure 7).

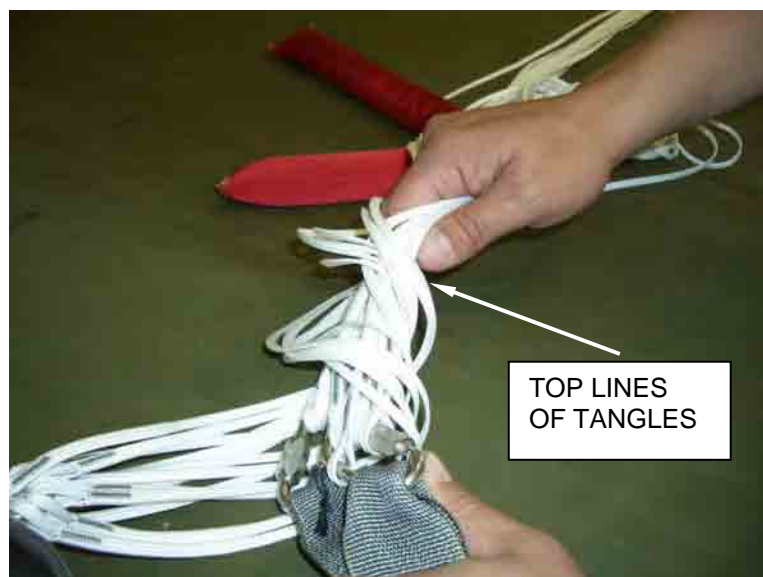

Figure 7. Reaching through Opening with Right Hand.

**PREPARING THE T-11 PERSONNEL PARACHUTE SYSTEM MAIN CANOPY FOR PROPER LAYOUT
– CONTINUED**

3. Pull the risers through the opening. Do not permit risers to turn (Figure 8). Continue to repeat these steps until group separation is achieved above and below the slider.

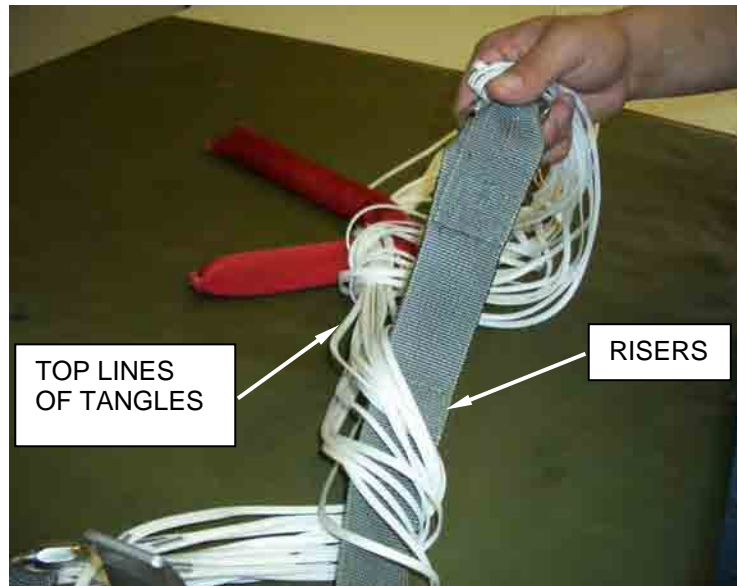

Figure 8. Pulling Risers through Opening.

4. Replace connector links on tension plate adapter.

END OF TASK

**PREPARING THE T-11 PERSONNEL PARACHUTE SYSTEM MAIN CANOPY FOR PROPER LAYOUT
– CONTINUED**

Twists. A twist occurs when the suspension lines within one group become improperly crossed (Figure 9).

NOTE

Insert packing weight around lines 1 and 14 while working on lines 15 and 28.

1. To remove twists, grasp the top and bottom inside lines (lines 1 and 14 right group) or (28 and 15 left group) at the skirt of canopy and trace them to the connector links. Ensure the four lines remain correctly oriented as they run through the slider.
2. Remove twists from one group at a time by rotating risers until lines are in proper location on the connector links. Do not remove suspension lines from connector links. If in doubt, perform a line continuity check IAW WP 0007.

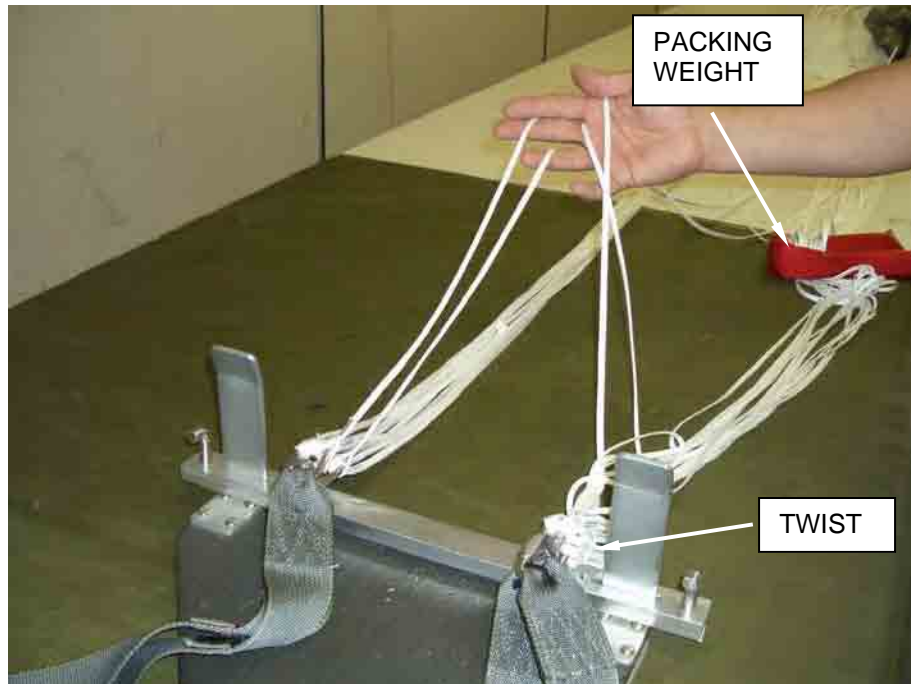

Figure 9. Twisted Suspension Lines.

END OF TASK

PREPARING THE T-11 PERSONNEL PARACHUTE SYSTEM MAIN CANOPY FOR PROPER LAYOUT – CONTINUED

Placing Deployment Sleeve on Deployment Sleeve Organizer

1. At the upper end of the pack table, detach the bridle line ring from the quick release hook and move the bridle line ring below the deployment sleeve organizer.
2. Swing the deployment sleeve organizer into position on pack table.
3. Open the hook and pile tape (Figure 10, Item 1) on the upper end of the deployment sleeve and feed the deployment sleeve onto the deployment sleeve organizer (Figure 10, Item 2). Ensure that the bridle line attachment loop (Figure 10, Item 3) is exposed and facing up.



Figure 10. Place Sleeve onto Sleeve Organizer.

PREPARING THE T-11 PERSONNEL PARACHUTE SYSTEM MAIN CANOPY FOR PROPER LAYOUT – CONTINUED

4. Continue to gather the deployment sleeve (Figure 11, Item 1) onto the sleeve organizer (Figure 11, Item 2) ensuring that all twists are removed. When completed, the data panel will face the top.
5. Push deployment sleeve back away from upper end of pack table approximately 2 inches clearing the quick release hook.



Figure 11. Pull Bridle Line through Sleeve.

6. Pull the bridle line and canopy (Figure 12, Item 1) through the deployment sleeve (Figure 12, Item 2) until the bridle line ring is at the upper end of the table.
7. Pass the strap and ring of the packing loop tension device (Figure 12, Item 3) up through the lower end of deployment sleeve (Figure 12, Item 2).



Figure 12. Pass Packing Loop Tension Device through Deployment Sleeve.

PREPARING THE T-11 PERSONNEL PARACHUTE SYSTEM MAIN CANOPY FOR PROPER LAYOUT – CONTINUED

8. Attach the bridle ring (Figure 13, Item 1) and packing loop tension device (Figure 13, Item 2) to the quick release hook (Figure 13, Item 3) at the upper end of the table.

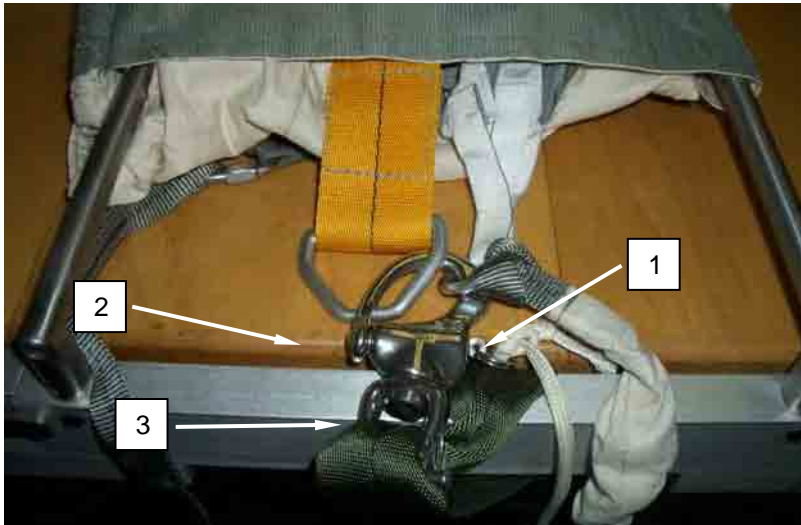

Figure 13. Attach Bridle Ring and Packing Loop Tension Device to Quick Release Hook.

END OF TASK

Perform Four Line Check

1. Position the slider as close to the tension plate as possible.
2. At the lower lateral band, split the canopy (Figure 14) between the left and right line groups. Right group consists of lines 1 through 14 and left group consists of lines 15 through 28.
3. Separate lines 1 and 28 and lines 14 and 15 (Figure 14) at the lower lateral band (located on each side of the data panel) and run the four lines to the connector links. Ensure the four lines remain oriented correctly as they run through the slider. There should be no twists.



Figure 14. Perform Four Line Check.

**PREPARING THE T-11 PERSONNEL PARACHUTE SYSTEM MAIN CANOPY FOR PROPER LAYOUT
– CONTINUED**

4. Place a 2-inch retainer band onto the tension plate adapter hooks to hold the risers from falling off during the stowing of the main canopy and suspension lines (Figure 15).



Figure 15. 2-Inch Retainer Band on Tension Plate Adapter.

END OF TASK

**PREPARING THE T-11 PERSONNEL PARACHUTE SYSTEM MAIN CANOPY FOR PROPER LAYOUT
– CONTINUED**

Attaching the Harness Assembly to the Pack Tray

1. Lay pack tray (Figure 16, Item 1) on pack table with the harness assembly attaching points (Figure 16, Item 2) facing up.
2. Place the harness assembly (Figure 16, Item 3) on the pack tray (Figure 16, Item 1) with the hip (Figure 16, Item 4) and shoulder pads (Figure 16, Item 5) facing up. Ensure the diagonal back straps intersect (Figure 16, Item 6) in the center of the pack tray, and ensure there are no twists in the upper main lift web (Figure 16, Item 7) and saddle assembly (Figure 16, Item 8).
3. Secure the horizontal back strap (Figure 16, Item 9) by routing both pack tray horizontal back strap retainers (Figure 16, Item 10) over the horizontal back strap (Figure 16, Item 9), and under the horizontal back strap keepers and secure the directional snap fasteners (Figure 16, Item 11).

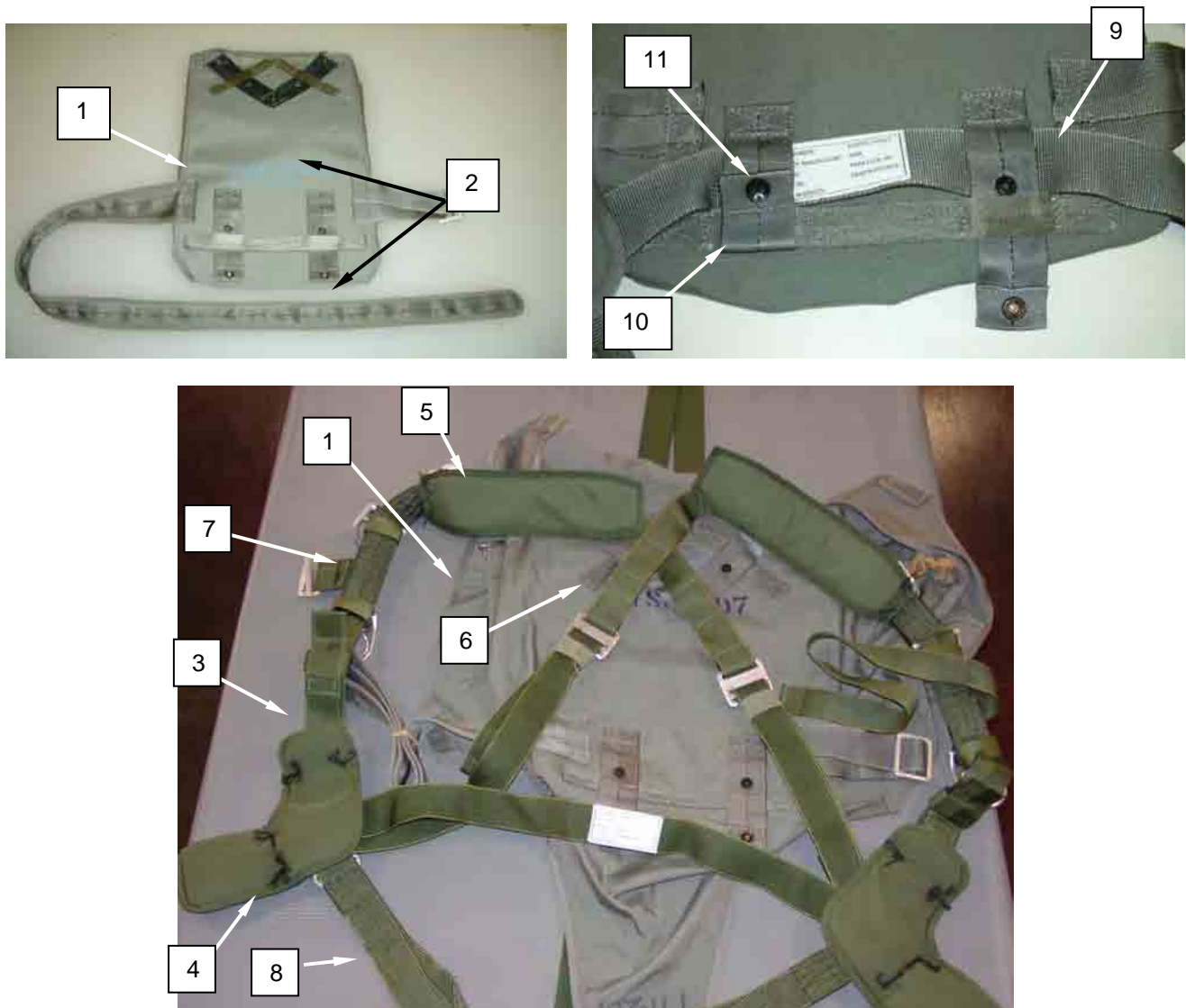

Figure 16. Pack Tray and Harness Assembly.

**PREPARING THE T-11 PERSONNEL PARACHUTE SYSTEM MAIN CANOPY FOR PROPER LAYOUT
– CONTINUED**

4. Attach diagonal back straps (Figure 17, Item 1) by routing the diagonal backstrap retainer (Figure 17, Item 2) through the selected sizing channel (Figure 17, Item 3).
5. Route the diagonal backstrap retainer (Figure 17, Item 2) under the diagonal backstrap keeper (Figure 17, Item 4).
6. Close directional snap fastener (Figure 17, Item 5) to secure.
7. Repeat for the opposite side (Figure 17, Item 6); ensure that the same sizing channel is used for both.
8. Enter the date placed in service on the horizontal back strap in data panel, if using a new harness assembly.

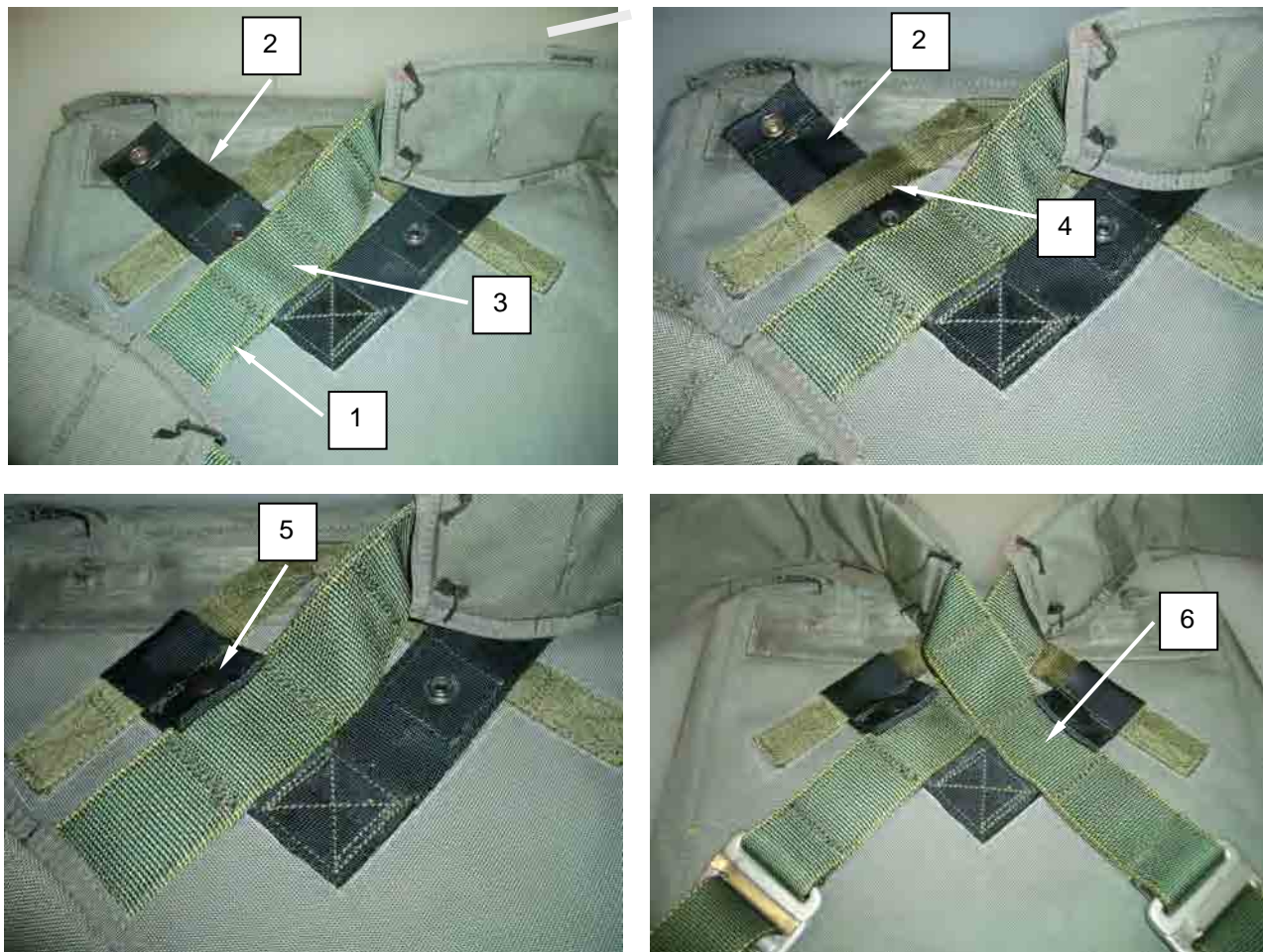

Figure 17. Securing Diagonal Back Straps.

END OF TASK

**PREPARING THE T-11 PERSONNEL PARACHUTE SYSTEM MAIN CANOPY FOR PROPER LAYOUT
– CONTINUED****Attach Risers To Harness Assembly**

1. Place the assembled harness assembly and pack tray (Figure 18, Item 1) on the packing table between the lower end of the packing table and the male fitting (Figure 18, Item 2) of the CRA.
2. Extend the riser assemblies so that slip assist tabs are facing up, the pack tray is against the table, the harness assembly is oriented with the canopy release assemblies on top, and the top closing flap is facing toward the upper end of the packing table. Ensure the riser assemblies (Figure 18, Item 3) and harness assembly (Figure 18, Item 4) is free of tangles and twists.
3. Seat the male fitting portion (Figure 18, Item 2) of the CRA into the female fitting (Figure 18, Item 5), by fitting the heel of the male fitting into the groove of the female fitting.
4. Fit the toe of the male fitting into the slot of the female fitting, close the latch (Figure 18, Item 6), and ensure the latch is securely locked.
5. Operate the latch and check for smooth operation. Close the latch.
6. Position the cable loop (Figure 18, Item 7) so that it sits below the lower end of the latch.
7. Fit the heel of the safety clip (Figure 18, Item 8) into the slot of the latch (Figure 18, item 6).
8. Close the safety clip (Figure 18, Item 8).
9. Repeat steps 3 through 8 for the opposite side.

10. Rigger check number 1.

**PREPARING THE T-11 PERSONNEL PARACHUTE SYSTEM MAIN CANOPY FOR PROPER LAYOUT
- CONTINUED**

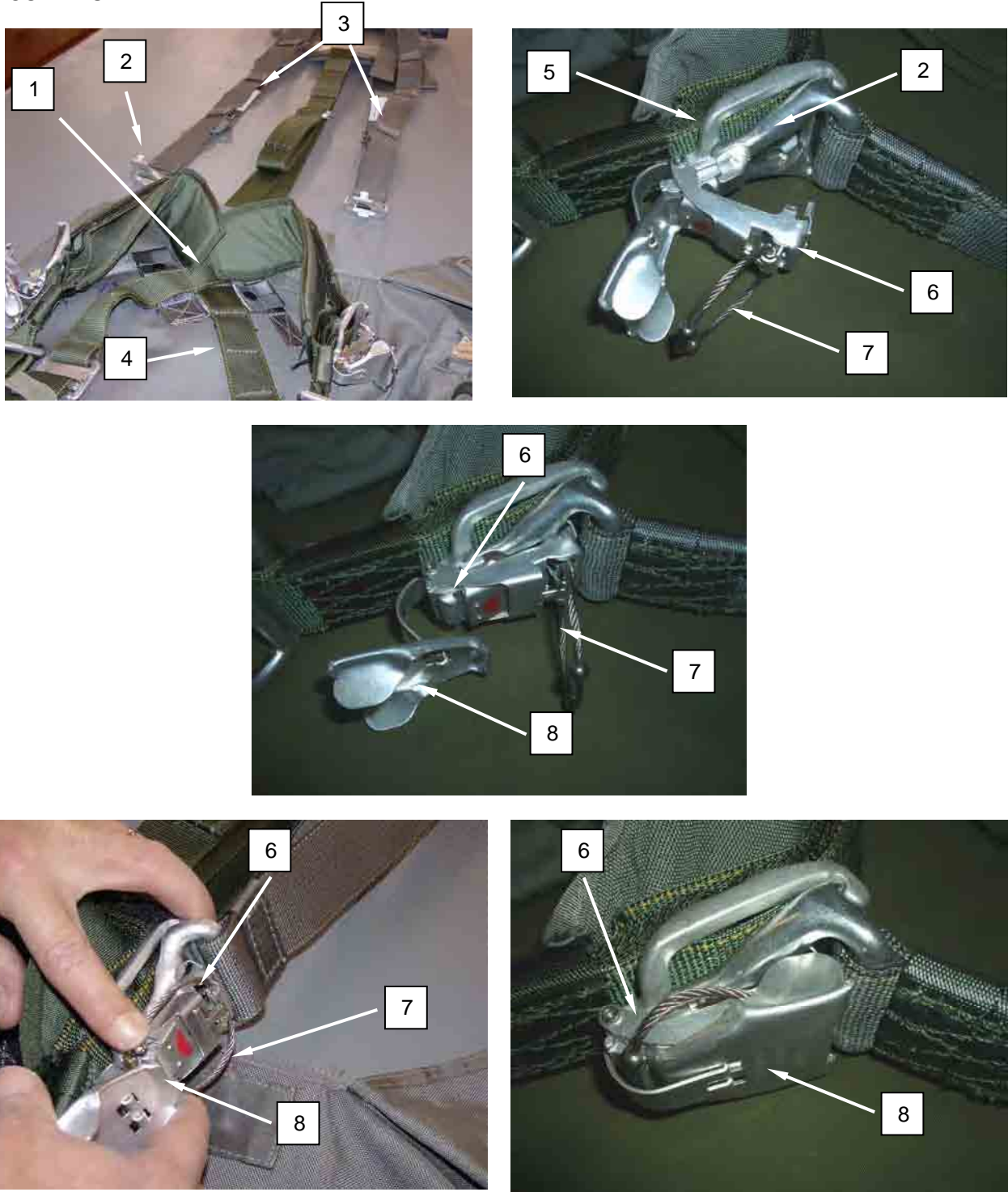

Figure 18. Laying Out Risers and Harness Assembly, and Assembling Risers and Harness Assembly.

END OF TASK

FOLDING THE PANELS**NOTE**

Packing loops are white. Packing tabs are foliage green.

1. At the lower lateral band, flip the right line group over the left line group to locate line number 14 (Figure 19, Item 1).
2. Trace seam number 14 to packing loop number 14 (Figure 19, Item 2) up to the top of the arm assembly.



Figure 19. Flip Right Line Group over Left Line Group and Locate Packing Loop 14.

NOTE

Ensure that packing loop tension device is 4 to 5 feet from the upper end of the packing table.

3. With the seam of line 14 (Figure 20, Item 1) against the table, place packing loop 14 (Figure 20, Item 2) onto the packing loop tension device. Adjust tension of the packing loop tension device and lower tension device as necessary.
4. With the left hand, ensure that all canopy fabric is to the left of seam 14. Grasp the exposed packing tab (Figure 20, Item 3) at the left side of the table and pull it over seam 14 to right side of table.



Figure 20. Pull Packing Tab from Left Side of Table to Right Side over Seam 14.

FOLDING THE PANELS – CONTINUED**NOTE**

Ensure that all material is neatly dressed within the panel.

5. Ensure that excess canopy fabric between the packing tab and packing loop is pushed in between each fold.
6. Picking up packing loop 13 (Figure 21, Item 1), place it on the packing loop tension device with the right hand, and pull out the packing tab with the left hand. Continue folding the top of the canopy.



Figure 21. Folding the Top of the Canopy.

FOLDING THE PANELS – CONTINUED

NOTE

After last fold, straighten tension plate as it has a tendency to move.

7. When the entire canopy is folded, seam 14 will be against the top of the table (Figure 22).



Figure 22. Canopy Folded and Seam 14 against Table.

8. Flip the folded canopy from the arm assembly to the lower lateral band (Figure 23, Item 1) over to the opposite side of the table so that the canopy is on the left half of the packing table.
9. Follow seam number 14 down the canopy to the lower lateral band (Figure 23, Item 2).



Figure 23. Follow Seam 14 to the Lower Lateral Band.

FOLDING THE PANELS – CONTINUED

10. Grasp all of the suspension lines together with left hand (Figure 24, Item 1) approximately 12 inches from lower lateral band starting with line 14 (Figure 24, Item 2), fold out each panel (Figure 24, Item 3) with a smooth motion to the right side with all of the suspension lines to the right of the packing table.



Figure 24. Grip Suspension Lines and Pull Each Panel of Lower Lateral Band.

11. Continue folding the panels (Figure 25, Item 1) pulling out the panels until all the panels have been folded.
12. Slide the canopy back onto the table.
13. Split the folds so that panels number 1 and 28 are on the top with the suspension lines centered on the table (Figure 25, Item 2).
14. Straighten the canopy from the lower lateral band to the packing loop tension device to form the flat fold.



Figure 25. Forming the Flat Fold.

END OF TASK

FOLDING THE PANELS – CONTINUED**Perform Slider Orientation****WARNING**

Proper orientation of the slider is critical to the performance of parachute deployment. Failure to ensure slider is properly oriented and not inverted could result in serious injury or death to the parachutist.

1. Locate line 1 (Figure 26, Sheet 1, Item 1) at the connector links and trace line 1 up to the slider (Figure 26, Sheet 1, Item 2).
2. Orient the slider so that the line 1 grommet (Figure 26, Sheet 1, Item 3) is toward the lower end of the packing table and the line 3 grommet (Figure 26, Sheet 1, Item 4) is toward the upper end of the packing table exposing the top of the slider grommet panel (Figure 26, Sheet 1, Item 5).
3. Grasp the top of the slider (Figure 26, Sheet 1, Item 6), pulling all fabric up and to the center of the left and right line groups. Fold the mesh portion (Figure 26, Sheet 2, Item 7) of the slider in half.
4. The reinforcement tapes of the slider should up and data blocks will be visible. All lines should be free of twists.

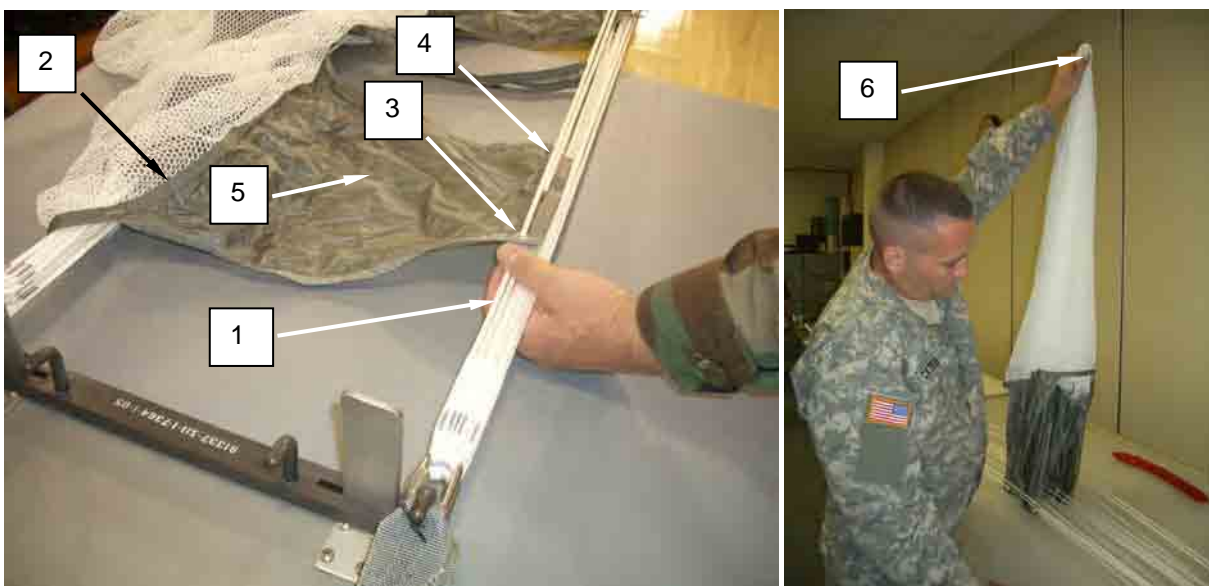

Figure 26. Perform Slider Orientation. (Sheet 1 of 2)

FOLDING THE PANELS – CONTINUED



Figure 26. Perform Slider Orientation. (Sheet 2 of 2)

5. Rigger check number 2.

6. Move the slider up to the lower lateral band. Unfold and fully extend slider neatly into the air channel (Figure 27, Item 1).

WARNING

Proper seating of the slider grommet is critical to performance of the parachute. Failure to do so could result in serious injury or death to the parachutist.

7. Seat the slider grommets (Figure 27, Item 2) by grasping the fabric of the slider and pushing the slider grommet firmly against the line attachment points.
- 8. Rigger check number 3.**

FOLDING THE PANELS – CONTINUED

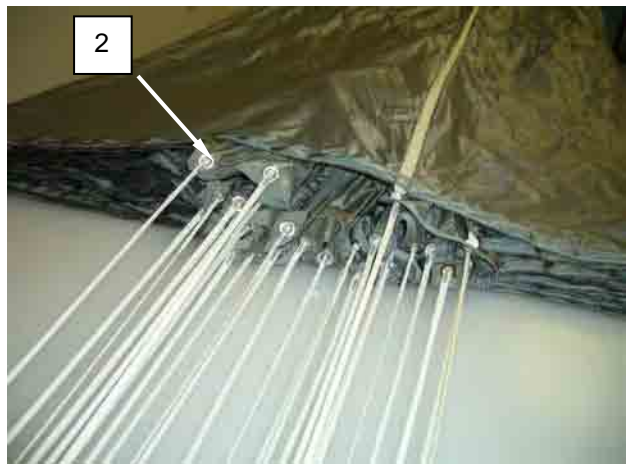

Figure 27. Move Slider and Place Neatly in Air Channel.

END OF TASK

LONG FOLDING THE CANOPY

1. Fold the right side of the canopy (Figure 28, Item 1) two thirds to the left.
2. Place packing weight (Figure 28, Item 2) on the lower lateral band.



Figure 28. Secure Canopy with Packing Weight.

LONG FOLDING THE CANOPY – CONTINUED

3. Continue folding the right side of the canopy to the packing loop tension device, placing packing weights, as needed.
4. Starting at the packing loop tension device, and moving towards the lower lateral band, fold the left side of the canopy (Figure 29, Item 1) over the right side of canopy and place packing weights (Figure 29, Item 2) as needed.
5. The canopy should be folded in thirds. Tuck any exposed corners back into the folded canopy.
6. Rigger check number 4.

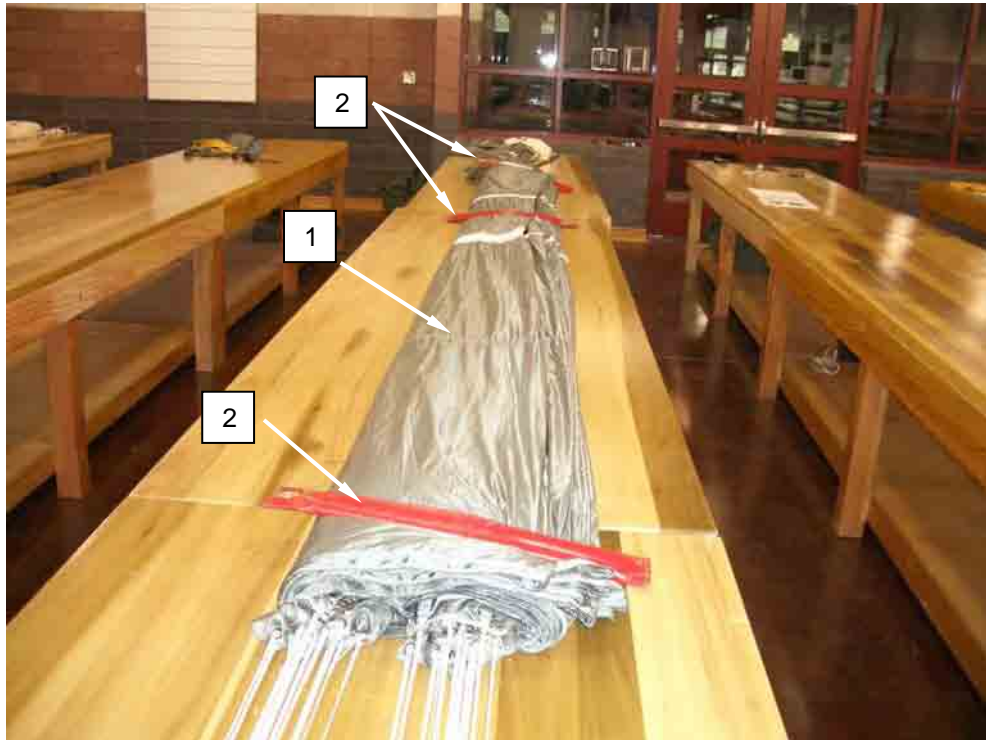

Figure 29. Canopy in Long Fold.

END OF TASK

PULLING DEPLOYMENT SLEEVE OVER THE CANOPY

1. Pull the deployment sleeve (Figure 30, Item 1) over the folded canopy (Figure 30, Item 2) until the packing loop tension device (Figure 30, Item 3) is even with the hook tape (Figure 30, Item 4) opening at the top of the deployment sleeve. When properly positioned, the bottom of the sleeve will be approximately 36 inches below the lower lateral band. Remove packing weights while pulling the deployment sleeve over the canopy.
2. Release tension at the lower tension plate. Remove tension plate adapter from the lower tension plate and move tension plate, to the left side of the packing table. Place a packing weight over the suspension lines and against the tension plate adapter.



Figure 30. Pull Deployment Sleeve over Canopy.

PULLING DEPLOYMENT SLEEVE OVER THE CANOPY – CONTINUED

3. Remove packing loops from packing loop tension device (Figure 31, Item 1) by rotating the packing loop tension device up 90 degrees.

WARNING



Failure to separate and remove entanglements from the packing loops may result in death to the parachutist.

4. Ensure packing loops are separated. Release the packing loop tension device (Figure 31, Item 1) and the bridle ring (Figure 31, Item 2) from the quick release hook (Figure 31, Item 3) at the upper end of the table and remove the packing loop tension device from the packing table.

■ **5. Rigger check number 5.**

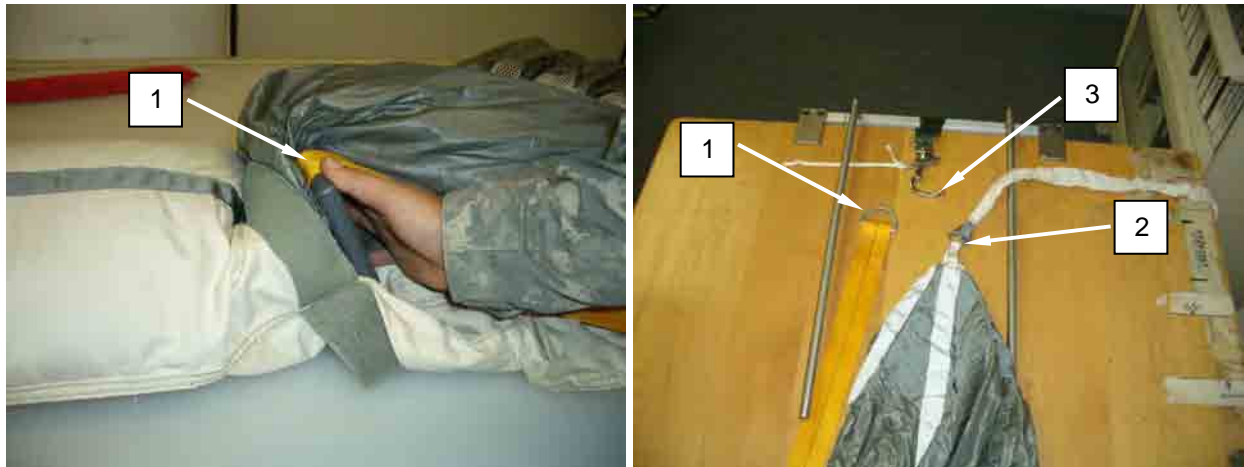

Figure 31. Release Packing Loop Tension Device.

6. Fully extend and dress the bridle line stowage panel (Figure 32, Item 1) toward the upper end of the table.
7. Gather the center section fabric (Figure 32, Item 2) together in a long fold.



Figure 32. Dressing Bridle Line Stowage Panel and Gathering Center Section Fabric.

PULLING DEPLOYMENT SLEEVE OVER THE CANOPY – CONTINUED

8. S-fold center section fabric (Figure 33, Item 1) the width and length of the bridle line stowage panel, placing one half of the S-folded portion inside the opening of the deployment sleeve (Figure 33, Item 2). Approximately two S-folds will be required.
9. Place the reinforcing panel (Figure 33, Item 3) evenly over the S-folded portion of the center section, inserting half the reinforcing panel (Figure 33, Item 3) into the end of the deployment sleeve.



Figure 33. S-Fold Center Section Fabric.

PULLING DEPLOYMENT SLEEVE OVER THE CANOPY – CONTINUED**CAUTION**

Do not use vise grips or other type pliers to hold connector link body when tightening, as damage to connector link can occur.

NOTE

Ensure that bridle line is pulled out until the bridle line connector link is visible.

10. Remove all turns, tangles, and twists from the bridle line (Figure 34, Item 1) by removing and reattaching the bridle line at the bridle line connector link. Ensure barrel nut closes toward the bridle line, faces to the right, and is finger tight. Starting to the left, fold the bridle across the width of the stowage flap in an alternating fashion until all the slack of the bridle line is taken up.
11. Stow the folded bridle line in the two large retainer bands (Figure 34, Item 2) one turn, single on the bridle line stowage panel.



Figure 34. Stow Folded Bridle in Two Large Retainer Bands on Deployment Sleeve.

■ **12. Rigger check number 6.**

13. Roll the bridle line stowage panel (Figure 35, Item 1) to the edge of the S-folded center section (Figure 35, Item 2).

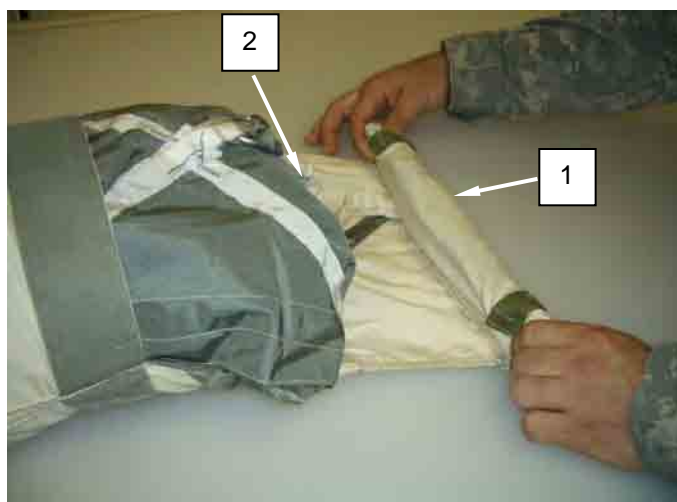

Figure 35. Roll Bridle Line Stowage Panel to Edge of S-Folded Center Section.

PULLING DEPLOYMENT SLEEVE OVER THE CANOPY – CONTINUED

14. Hold the rolled bridle line stowage panel (Figure 36, Item 1) in place and pull the top end of the deployment sleeve (Figure 36, Item 2) over and around the top end of the canopy.

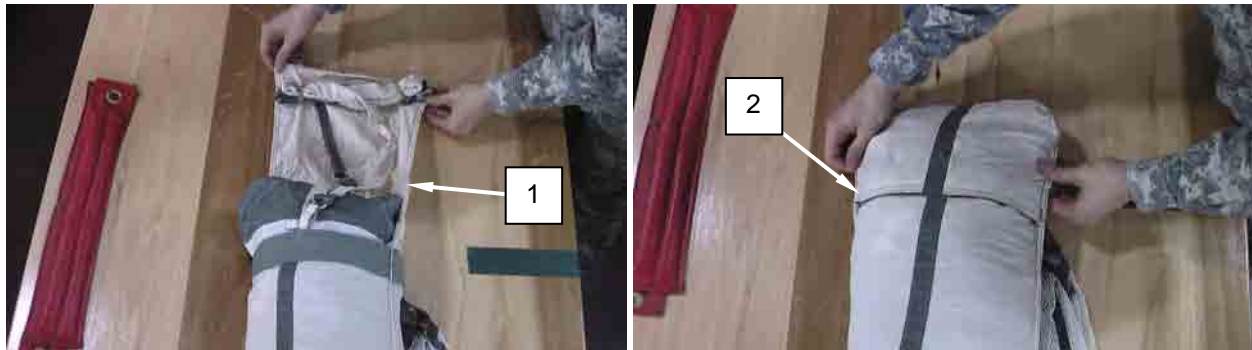

Figure 36. Hold Rolled Bridle Line Stowage Panel and Pull Top of Deployment Sleeve over Canopy.

CAUTION

Hook and pile tape must be aligned in order to prevent damage to parachute by searing (i.e. friction caused by pieces rubbing together during deployment).

15. Mate the hook and pile tape (Figure 37, Item 1) on the deployment sleeve ensuring no canopy fabric is trapped between the hook and pile.



Figure 37. Mate Hook and Pile Tape on Sleeve.

END OF TASK

ATTACHING DEPLOYMENT BAG TO CRADLE

1. Rotate deployment sleeve organizer out of the way from the top of the pack table and place the deployment bag cradle on the floor at the upper end of the packing table.
2. Place the deployment bag into the deployment bag cradle (Figure 38, Item 1) so that the locking stow panel (Figure 38, Item 2) is nearest the packing table.
3. Ensure that the four deployment bag securing loops are secured on the post (Figure 38, Item 3) of the deployment bag cradle.

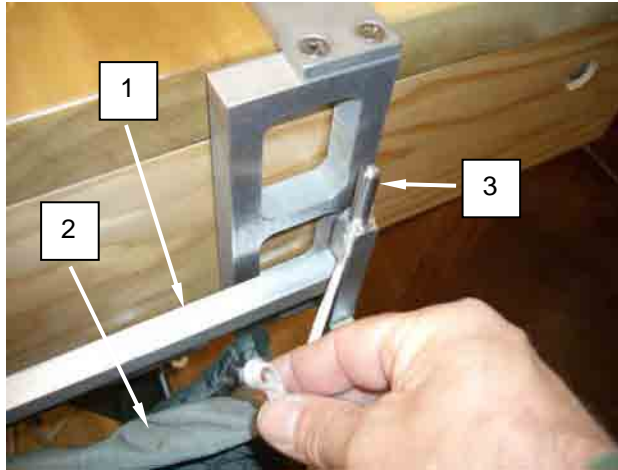

Figure 38. Place Deployment Bag into Deployment Bag Cradle.

ATTACHING DEPLOYMENT BAG TO CRADLE – CONTINUED

4. Route each end of the deployment bag securing loops (Figure 39, Item 1) through the four sewn loops (Figure 39, Item 2) at the top of the reinforcement tape located at the mouth of the bag and position them onto the four posts (Figure 39, Item 3) atop the deployment bag cradle.

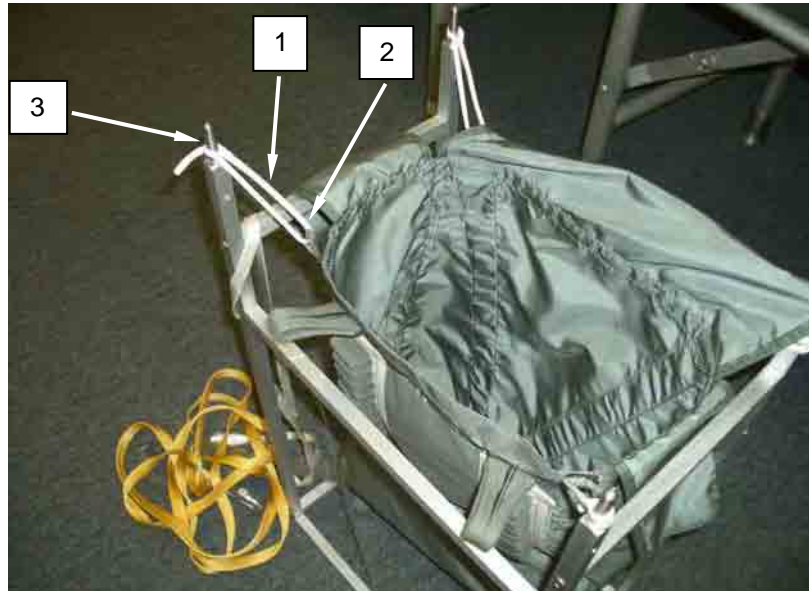

Figure 39. Secure Deployment Bag to Deployment Cradle.

END OF TASK**PLACING THE DEPLOYMENT SLEEVE AND CANOPY IN DEPLOYMENT BAG**

1. Place the canopy portion of the drogue parachute (Figure 40, Item 2) in the bottom of the deployment bag (Figure 40, Item 1).

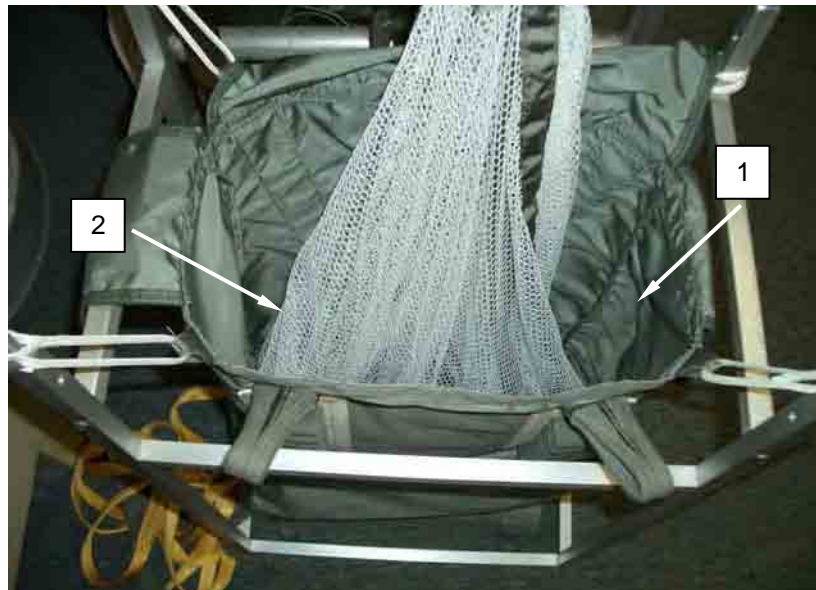

Figure 40. Place Drogue Parachute in Bottom of Deployment Bag.

PLACING THE DEPLOYMENT SLEEVE AND CANOPY IN DEPLOYMENT BAG – CONTINUED

2. Ensure that the canopy portion (Figure 41, Item 1) of the drogue parachute is evenly distributed at the bottom of the deployment bag (Figure 41, Item 2).

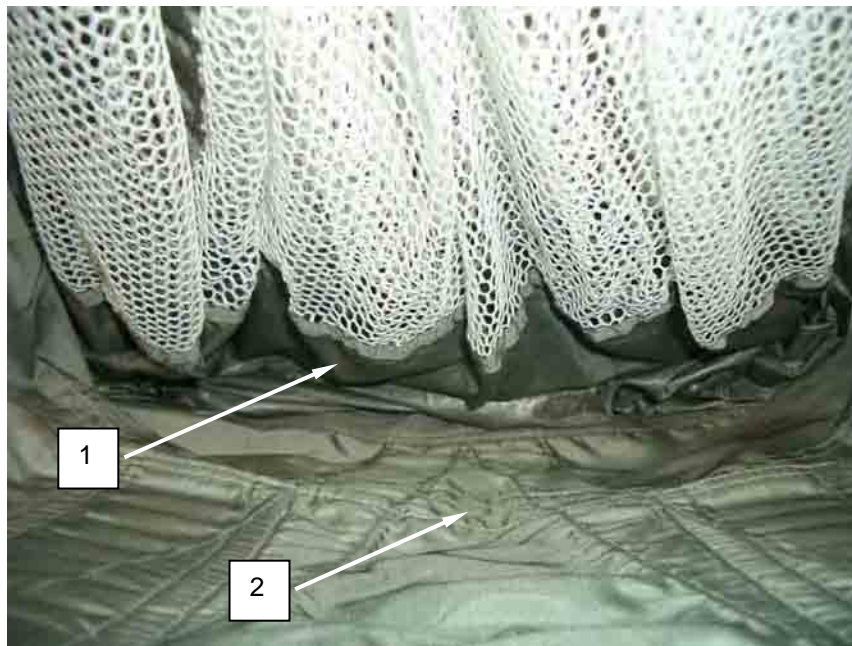

Figure 41. Place Drogue Parachute into Deployment Bag.

3. Rigger check number 7.

4. Place the mesh portion of the drogue parachute straight to the bottom of the deployment bag. Place the bridle line storage panel (Figure 42, Item 1) of the deployment sleeve into the right side bottom (Figure 42, Item 2) of the deployment bag parallel to the upper end of the packing table. Ensure that the reinforcement tape (Figure 42, Item 3) on the deployment sleeve always faces the rigger as the sleeve goes into the deployment bag.



Figure 42. Place Top of Deployment Sleeve in Deployment Bag.

PLACING THE DEPLOYMENT SLEEVE AND CANOPY IN DEPLOYMENT BAG – CONTINUED

5. Continue to stow the deployment sleeve (Figure 43, item 1), evenly filling the deployment bag (Figure 43, item 2) in an S-folding fashion, moving from corner to corner in a clockwise direction. When the lower lateral band is reached, gather the deployment sleeve (Figure 43, item 1) around the suspension lines (Figure 43, item 3) and continue stowing, ensuring that the bottom of the deployment sleeve is centered and against the deployment bag locking stow panel (Figure 43, item 4).



Figure 43. Bottom of Sleeve Placed at Bottom and Center of Bag.

END OF TASK

CLOSING THE DEPLOYMENT BAG

1. Fold the side flaps (Figure 44, Item 1) of the deployment bag over the deployment sleeve (Figure 44, Item 2).



Figure 44. Fold Side Flaps over Deployment Sleeve.

2. Lay the suspension lines (Figure 45, Item 1) toward 12 o'clock over the side flaps with the running ends draped outside left of the cradle (Figure 45, Item 2). Fold the locking stow panel over top of suspension lines. Insert locking stow loops up through locking stow panel. Secure the locking stow panel (Figure 45, Item 3) with stow hooks (Figure 45, Item 4) through the locking stow loops (Figure 45, Item 5) from outside to inside.

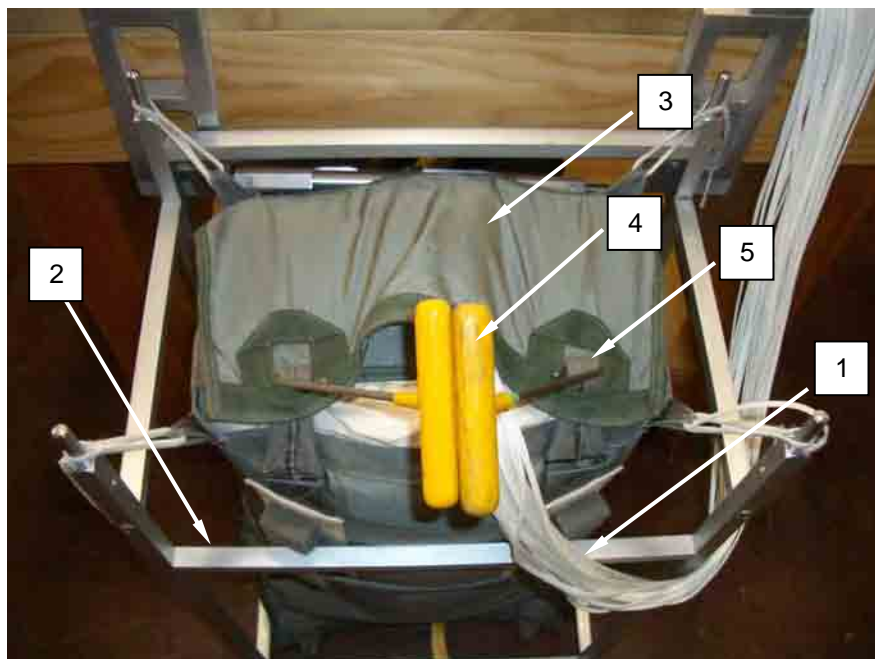

Figure 45. Secure Locking Stow Panel with Stow Hooks.

CLOSING THE DEPLOYMENT BAG – CONTINUED

3. Place either foot on the deployment bag cradle and lift up on stow hook handles (Figure 46, Item 1).
4. Remove the deployment bag securing loops from the sewn loops by slightly lifting the deployment bag from the cradle and freeing the loops from the cradle posts.
5. Place the deployment bag on the table with the stow panels (Figure 46, Item 2) facing the upper end of table.
6. Move the deployment bag cradle out of the way.

NOTE

Ensure that the locking stows are even with the edge of the deployment bag flap.

7. Make the first locking stow through the locking stow loop (Figure 46, Item 3) to the upper right (rigger's view) of the deployment bag with the running end toward the lower end of pack table.



Figure 46. Make First Locking Stow.

8. Make the second locking stow through the locking stow loop (Figure 47, Item 1) to the upper left (rigger's view) with the running end toward the lower end of the table.



Figure 47. Make Second Locking Stow.

CLOSING THE DEPLOYMENT BAG – CONTINUED

9. Lay deployment bag (Figure 48, Item 1) on table with stow panel (Figure 48, Item 2) facing up. Using forearm, flatten the deployment bag from the middle (Figure 48, Item 3) to bottom of the deployment bag forming a wedge.
10. Remove stow hooks.



Figure 48. Flattening the Deployment Bag to Form a Wedge.

NOTE

All regular stows will extend approximately 1½ to 2 inches past the stow loops. There should be a minimum of six and a maximum of seven stows on each panel.

11. Make the first regular stow (Figure 49, Item 1) to the upper right stow loop (rigger's view).



Figure 49. Make First Regular Stow.

- 12. Rigger check number 8.
Change 1

CLOSING THE DEPLOYMENT BAG – CONTINUED

13. Continue stowing suspension lines from left to right (rigger's view) until no more than 12 inches of suspension line (Figure 50, Item 1) remains.
14. Remove the stow hooks. Remove connector links from tension plate adapter.
15. Fold excess slack from remaining suspension lines over the stowed suspension lines.



Figure 50. Continue Stowing Suspension Lines.

NOTE

Packer has the option of standing the deployment bag up during tying of connector links.

16. Using one, 36-inch length of Type I, ¼-inch cotton webbing (Figure 51, Item 1) one-turn doubled on the right side, route in a continuous motion through bottom right deployment bag loop (Figure 51, Item 4), up through the right set of connector links (Figure 51, Item 3). Leave the running ends off to the side.
17. Repeat for opposite side.

NOTE

Ensure suspension lines are not routed over the barrel nuts.

18. Rigger check number 9.

19. Pull the suspension line protector flap over the stowed suspension lines and continue routing the Type I, ¼-inch cotton webbing from inside to outside through the suspension line protector flap tie loop.
20. Secure with a surgeon's knot, locking knot.
21. Repeat for opposite side.

CLOSING THE DEPLOYMENT BAG – CONTINUED

Figure 51. Secure Connector Links with Cotton Webbing.

22. Trim running ends leaving 1 inch of excess (Figure 52).

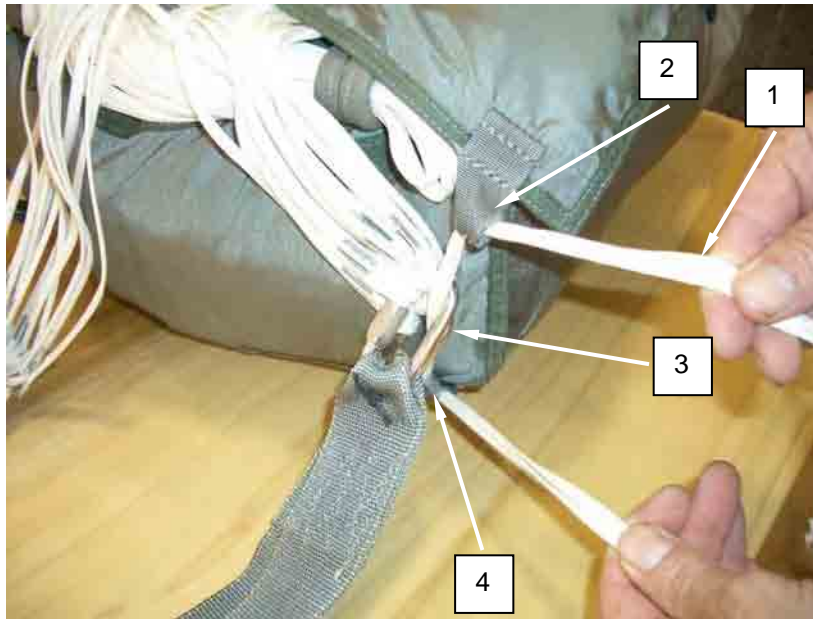

Figure 52. Secure Both Sides with a Surgeon's Knot Locking Knot.

CLOSING THE DEPLOYMENT BAG – CONTINUED

23. Enter deployment bag number in the log record (Figure 53, Item 1). Stow log record in log record pocket.

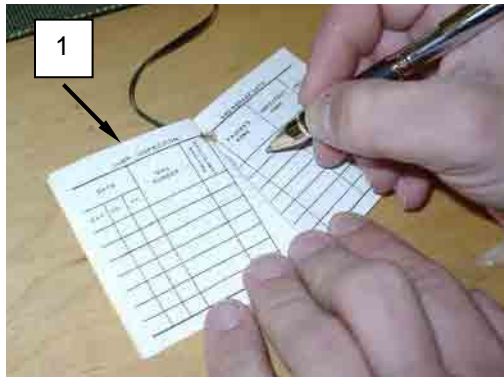

Figure 53. Enter Deployment Bag Number in Log Record.

24. Rigger check number 10.

END OF TASK

CLOSING THE PACK TRAY

1. Grasp the canopy release assemblies (Figure 54, Item 1) and the upper edge of the pack tray. Lift and flip the main pack tray (Figure 54, Item 2) under the risers. Align the lower edge of the slip assist tabs (Figure 54, Item 3) with the lower edge (Figure 54, Item 4) of the pack tray.

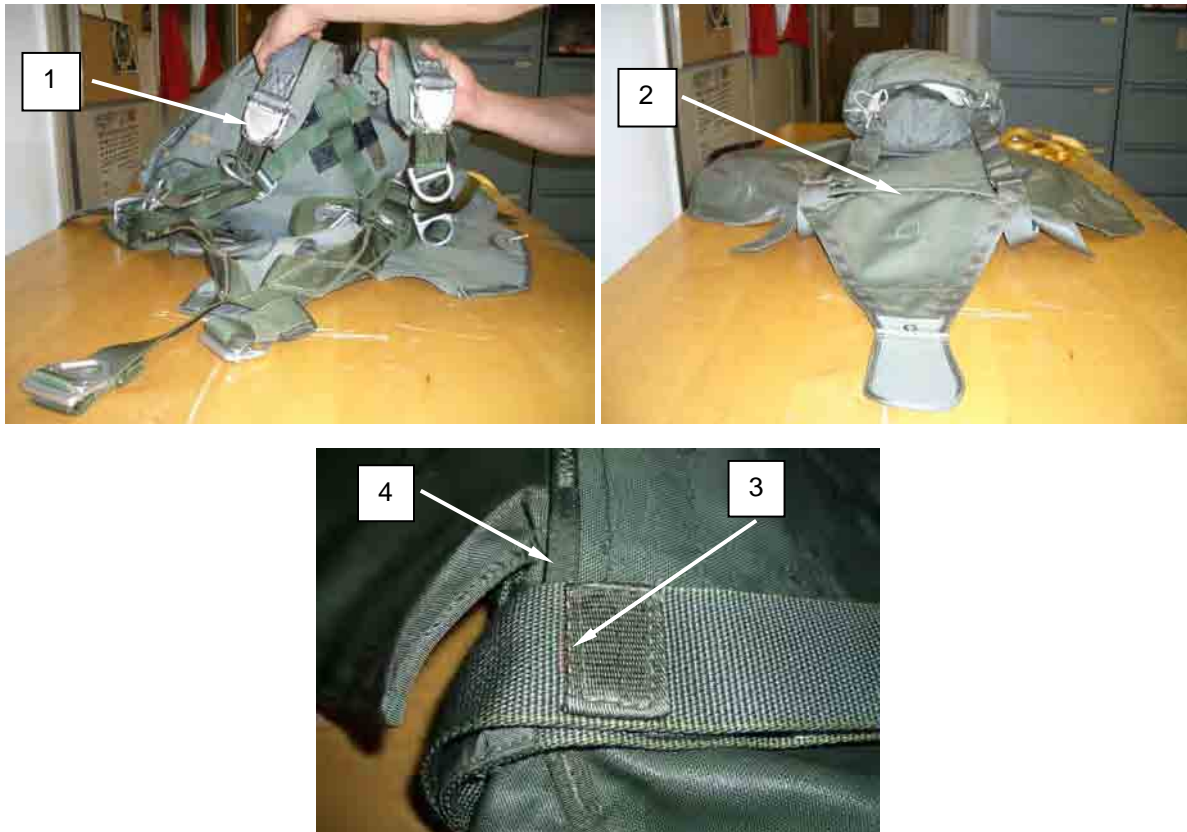

Figure 54. Rotate Main Pack Tray under Risers.

CLOSING THE PACK TRAY – CONTINUED

2. With the left hand, position and hold the risers (Figure 55, Item 1) neatly against the bottom of the main pack tray (Figure 55, Item 2). Grasp the edge of the suspension line protective flap (Figure 55, Item 3) with the right hand and lift and slide the deployment bag onto the pack tray, positioning the top of the deployment bag (Figure 55, Item 4) even with the pack tray upper edge (Figure 55, Item 5).



Figure 55. Placing the Deployment Bag on Pack Tray.

CLOSING THE PACK TRAY – CONTINUED**NOTE**

Closing sequence for the Main Pack Tray is right flap, left flap, lower flap, upper flap (rigger's view).

Use of a packing T-bar is optional, and may aid in pulling the closing loop through the grommet.

3. Insert a pull-up cord (Figure 56, Item 1) through the closing loop (Figure 56, Item 2). Using the pull-up cord, pass the closing loop through the grommet (Figure 56, Item 3) in the opposing side flap (Figure 56, Item 4). Secure with a temporary pin (Figure 56, Item 5).
4. Dress top and bottom of the side flaps.

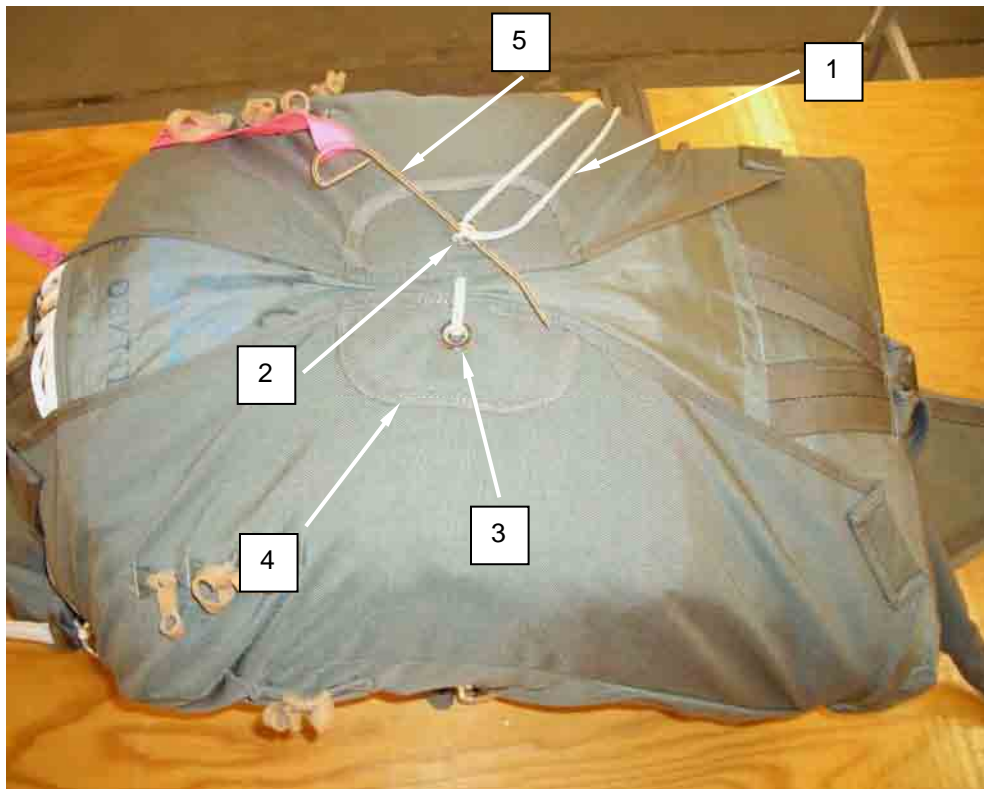

Figure 56. Close Side Flaps and Secure with Temporary Pin.

CLOSING THE PACK TRAY – CONTINUED

5. Remove all twists from the universal static line (modified) (Figure 57, item 1). Position the curved pin (Figure 57, item 2) on the right side of the pack tray grommets (Figure 57, item 3) facing the pin to the right. Tuck the static line sleeve excess (Figure 57, item 4) into the lower left (rigger's view) corner of the pack tray (Figure 57, item 5).



Figure 57. Stowing of Modified Universal Static Line inside Pack Tray.

CLOSING THE PACK TRAY – CONTINUED

6. Using a pull-up cord (Figure 58, Item 1), pass the closing loop (Figure 58, Item 2) through the grommet (Figure 58, Item 3) in the lower flap (rigger's view) (Figure 58, Item 4). Secure with a temporary pin (Figure 58, Item 5).

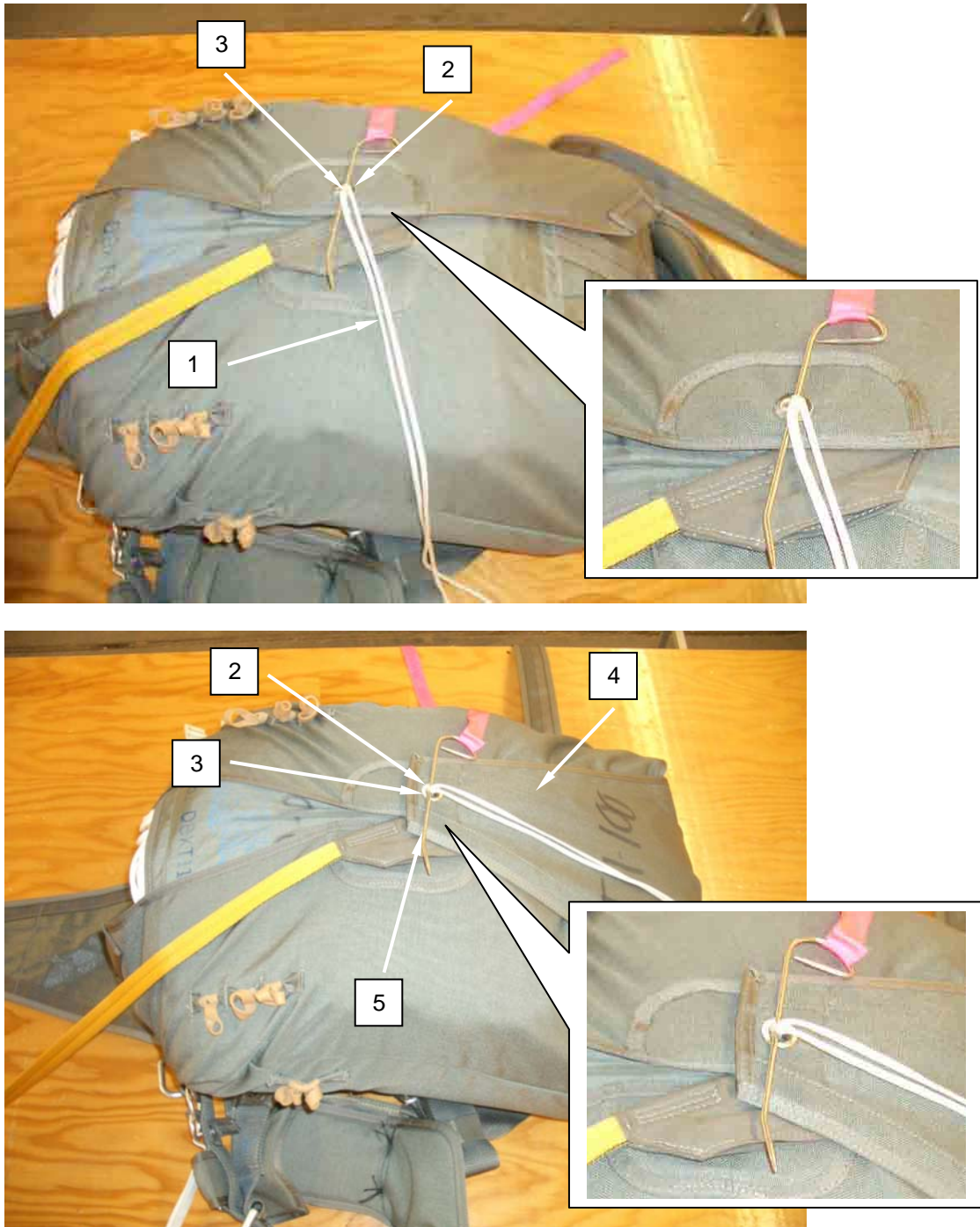

Figure 58. Close Bottom Flap and Secure with Temporary Pin.

CLOSING THE PACK TRAY – CONTINUED

7. Rotate the pack tray one quarter turn clockwise. Using a pull-up cord (Figure 59, Item 1), pass the closing loop (Figure 59, Item 2) through the grommet (Figure 59, Item 3) in the upper flap (rigger's view) and secure using the temporary pin (Figure 59, Item 4).
8. Align the lower edge (rigger's view) of the main curved pin cover (Figure 59, Item 5) and the upper edge of the static line sleeve with the hinge point of the main curved pin protector flap (Figure 59, Item 5). Remove temporary pin. Secure using the main curved pin (Figure 59, Item 6). The pin should be facing to the left (rigger's view).
9. **Rigger Check number 11.**
10. Dress upper, lower, and side flaps.

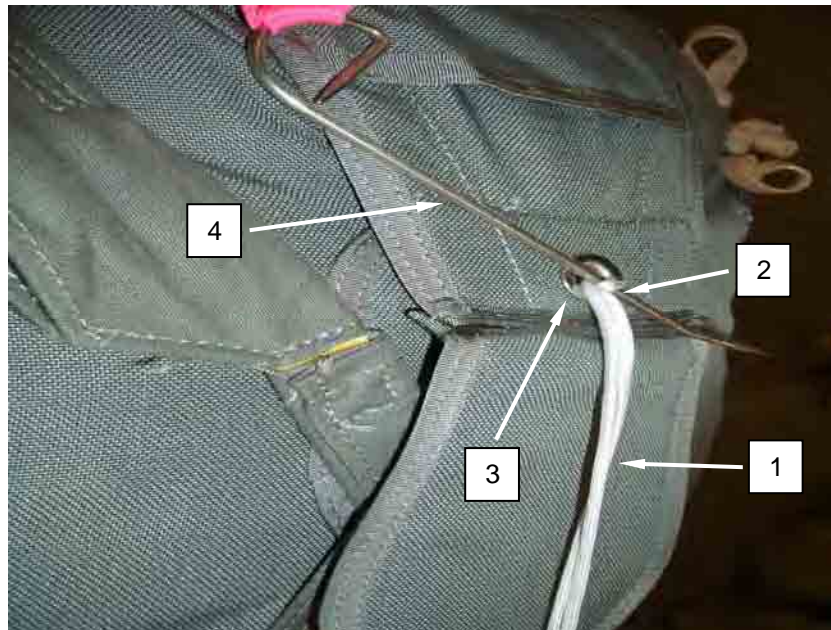

Figure 59. Close Top Flap and Secure with Main Curved Pin.

CLOSING THE PACK TRAY – CONTINUED

11. Remove the pull-up cord by routing it under main curved pin and pull out slowly, then close the main curved pin protector flap (Figure 60, Item 3) and secure it in the tuck flap (Figure 60, Item 4).
12. Make first static line stow (Figure 60, Item 1) to the lower left (rigger's view) of the left outer static line stow bar. Stows are stowed with two turns of large retainer bands (Figure 60, Item 2). Ensure that static line extends 2 inches beyond retainer bands.



Figure 60. Make First Static Line Stow, Close and Secure Pin Protector Flap.

NOTE

There will be two static line stows on each outer static line stow bar, two stows on the left (rigger's view) inner static line stow bar, and one stow on the right (rigger's view) inner static line stow bar.

13. Make second static line stow to the bottom right (rigger's view) outer static line stow bar.
14. Third static line stow will be to the left (rigger's view) outer static line stow bar.
15. Fourth static line stow will be to the right (rigger's view) outer static line stow bar.
16. Fifth static line stow will be to the left (rigger's view) inner static line stow bar.
17. Sixth static line stow will be to the right (rigger's view) inner static line stow bar.
18. Seventh static line stow will be to the left (rigger's view) inner static line stow bar.

CLOSING THE PACK TRAY – CONTINUED

19. Attach the static line snap hook (Figure 61, Item 1) to the right outer static line stow bar.
20. Stow excess static line up through static line slack retainer band (Figure 61, Item 2) one turn, single with 1¼-inch retainer band.



Figure 61. Continue Stowing Static Line Across the Top of the Pack Tray.

END OF TASK

CLOSING THE PACK TRAY – CONTINUED**Stowing the 5-Foot Static Line Extension (if used)****NOTE**

When using the 5-foot static line extension, the girth hitch (refer to WP 0007) will fall between the eighth and ninth static line stows.

1. Place one additional large retainer band on each inner static line stow bar.
2. Make the eighth static line stow to the inner right (rigger's view) static line stow bar.
3. Make the ninth static line stow to the inner left (rigger's view) static line stow bar.
4. Make the tenth static line stow to the inner right (rigger's view) static line stow bar.
5. Make the last static line stow to the inner left (rigger's view) static line stow bar.
6. Attach the static line snap hook (Figure 62, Item 1) to the right (rigger's view) outer stow bar.
7. Stow excess static line in the static line slack retainer band.



Figure 62. Continue Stowing Static Line across the Top of the Pack Tray (shown with Static Line Extension).

END OF TASK

PARACHUTE LOG RECORD**CAUTION**

All packing aids must be accounted for after completion of packing.

Beginning with the initial packing of a parachute, and each time a parachute is repacked, the log record (Figure 63) must be completed, as follows:

1. Remove the log record (Figure 63, Item 1) from the parachute inspection data pocket (log record pocket) (Figure 63, Item 2) by partially pulling out the right riser (rigger's view) (Figure 63, Item 3).

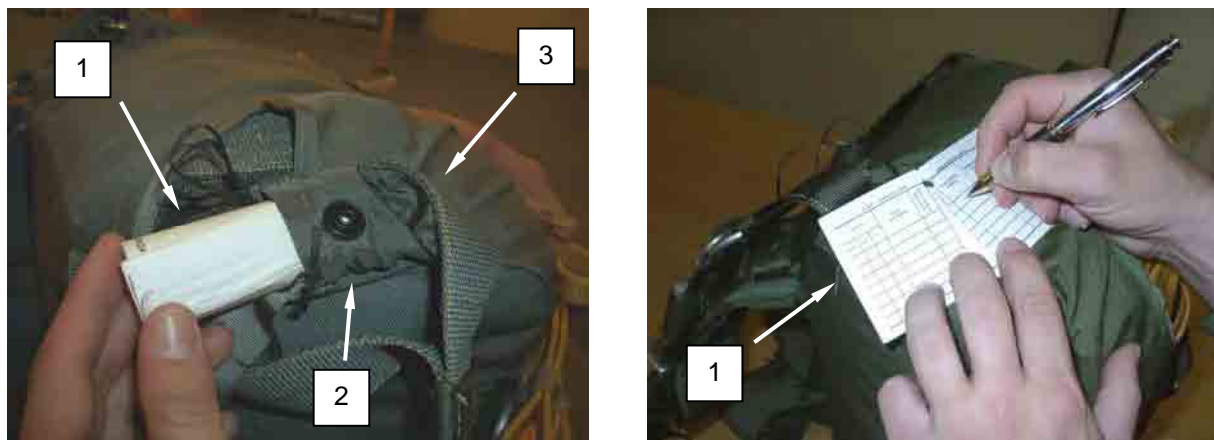

Figure 63. Fill Out Log Record.

2. Make entries on the JUMP, INSPECTION AND REPACK DATA page, as follows:
 - a. Date. Enter the day, month, and year of each packing action.
 - b. Bag Number. Entry made in the CLOSE THE PACK TRAY section, step 1, earlier in this work package.
 - c. Routine inspection. No entry required.
 - d. Repack. For initial packing, enter IN; thereafter, enter a checkmark in the column each time the parachute is packed.
 - e. Packer's name. The packer performing the packing will sign this entry.
 - f. Inspector's name. The inspector who has performed the pack-in-process inspection will sign this entry.
 - g. Unit. Enter the unit designation to which the packer and/or inspector is assigned.
3. Return the log record to the log record pocket upon completion of the entries.
4. Re-stow and dress riser. Packing is now completed.
5. **Rigger check number 12.**

END OF TASK

FOLDING THE HARNESS ASSEMBLY

For easier handling of the T-11 after packing is completed, fold the harness assembly as follows:

1. Turn the parachute over and place an aviator's kit bag (Figure 64, Item 1) folded in thirds on top of the pack tray with carrying handle facing up. Fasten the chest strap (Figure 64, Item 2) to the 1-inch quick-fit friction adapter (Figure 64, Item 3) and install a 4-inch quick release.



Figure 64. Connect Chest Strap to 1-inch Quick-fit Friction Adapter.

2. Pull both leg straps (Figure 65, Item 1) through the kit bag carrying handle and under the diagonal back straps. Criss-cross the leg straps (Figure 65, Item 1), and attach the leg straps to the leg strap quick-ejector snaps (Figure 65, Item 2).



Figure 65. Attach Leg Straps to Leg Strap Quick-Ejector Snaps.

FOLDING THE HARNESS ASSEMBLY – CONTINUED

3. Grasp the saddle and pull straight up. Route the waistband (Figure 66, Item 1) under the saddle and completely around the harness assembly. Pull tightly.



Figure 66. Route Waistband under Saddle.

4. Thread the waistband (Figure 67, Item 1) back through the saddle, into the waistband metal adjuster (Figure 67, Item 2), and install a quick-release.

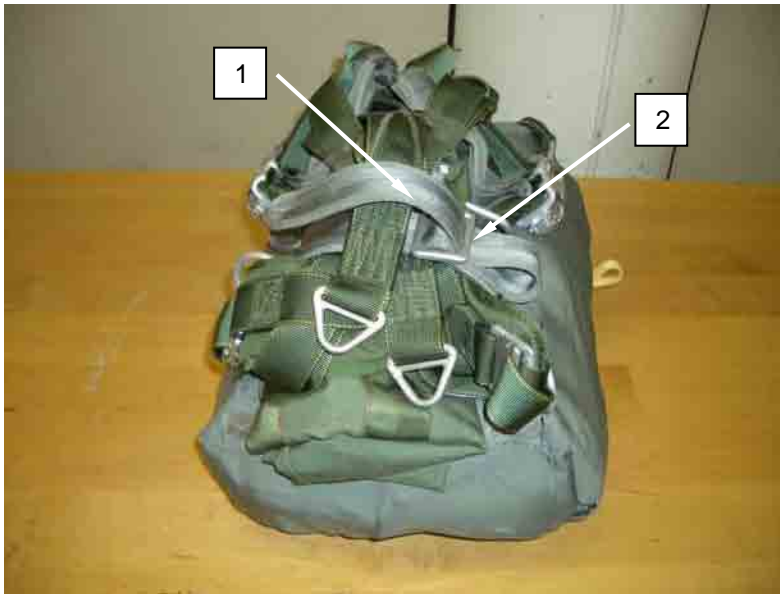

Figure 67. Adjust Saddle and Waistband.

5. Account for all packing aids.

END OF TASK

END OF WORK PACKAGE

FIELD MAINTENANCE

RESERVE PARACHUTE PACKING PROCEDURES
SERVICE**INITIAL SETUP:****Tools and Special Tools**

Adapter, Tension Plate (WP 0102, Item 1)
 Knife, Pocket (WP 0102, Item 25)
 Line Separator (WP 0102, Item 27)
 Needle, Upholsterer's, Curved, Size 5 (WP 0102, Item 32)
 Packing Rod, Reserve Ejector Spring (WP 0102, Item 34)
 Paddle, Parachute, Packing (WP 0102, Item 35)
 Pin, Temporary Packing (WP 0102, Item 36)
 Plate, Tension, Parachute Packing (WP 0102, Item 37)
 Scissors, 8-Inch (WP 0102, Item 48)
 T-Bar Packing (WP 0102, Item 66)
 Weight, Parachute Packing (WP 0102, Item 69)

Personnel Required

Parachute Rigger 92R1P (1)
 Parachute Rigger 92R2P (1)

References

SF 368
 WP 0008
 WP 0012
 WP 0058
 WP 0072
 WP 0082
 WP 0084

Materials/Parts

Band, Rubber Parachute, 1-¼-inch Long x 3/8-inch wide (WP 0101, Item 2)
 Band, Rubber Parachute, 2 inches Long x 3/8-inch Wide (WP 0101, Item 3)
 Cord, Fibrous, Nylon, MIL-C-5040H, Red, Type III (WP 0101, Item 15)
 Tape, Lacing and Tying, A-A-52080-B-3 (WP 0101, Item 41)
 Thread, Cotton, Ticket 8/4, Orange, A-A-52094 (WP 0101, Item 48)
 Webbing, Textile, Cotton, Type I, ¼-inch Wide, Natural (WP 0101, Item 68)

Equipment Condition

Laid out on packing table or other suitable area.

GENERAL

This work package contains the packing procedures for the T-11 Reserve.

Read all warnings and cautions within this section and follow procedures outlined herein to ensure safe operation of the T-11 Reserve and associated equipment.

PREPARING THE T-11 RESERVE FOR PROPER LAYOUT**WARNING**

If the reserve canopy has been deployed in a known high-speed malfunction, the reserve canopy will be removed from service. Continued use may cause the canopy to fail resulting in serious injury or death to the parachutist.

WARNING

If the reserve canopy has been deployed for any reason, determine the reason for deployment. In any event, the skirt assist line attachment points shall be inspected to determine if the Type I, ¼-inch cotton webbing has broken. If any skirt assist lines are broken, and it has been determined the reserve canopy was NOT involved in a known high speed deployment, remove and replace the skirt assist ties with Type I, ¼-inch cotton webbing IAW WP 0058.

Inspection

If defects or damage are discovered during inspection of a parachute, the parachute must be rigger-rolled and processed for maintenance in accordance with WP 0082.

Pack-In-Process Inspection. A designated supervisory rigger, other than the packer, must perform a pack-in-process inspection. The inspection is performed to assure that the parachute is packed according to authorized packing procedures. Refer to WP 0012 for inspection procedures.

Orientation

Throughout this manual, all directions (right, left, upper, lower, top, bottom, clockwise, and counterclockwise) are given from the rigger's point of view, as the rigger stands at the tension plate end of the packing table, facing the apex hook end of the table. All directions are indicated as the parachute is in proper layout.

1. Top. That portion of the equipment that is farthest from the packing table surface.
2. Bottom. That portion of the equipment that is nearest to the packing table surface.

PREPARING THE T-11 RESERVE FOR PROPER LAYOUT - CONTINUED

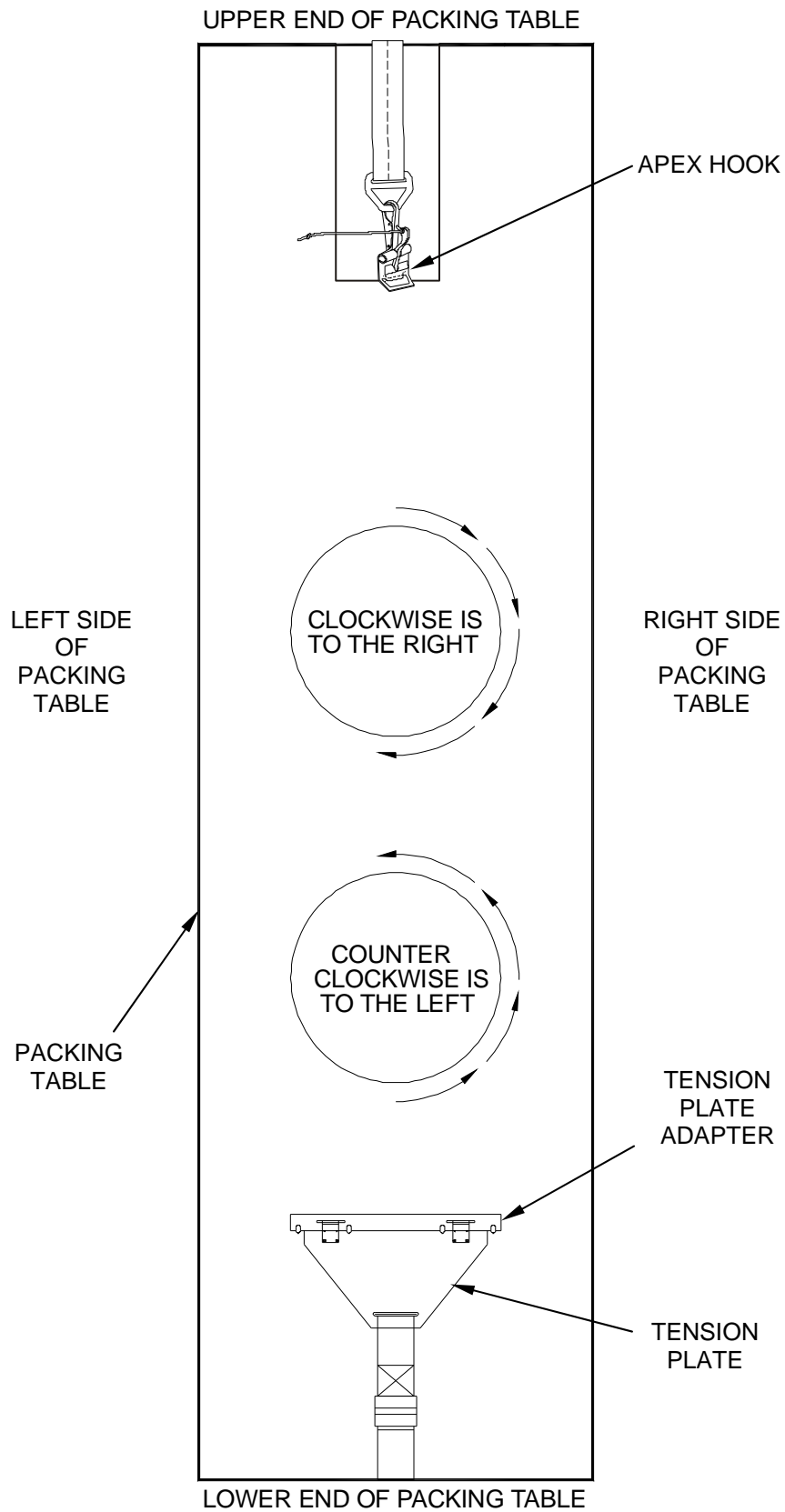

Figure 1. Rigger's View.

PREPARING THE T-11 RESERVE FOR PROPER LAYOUT - CONTINUED

WARNING



Failure to detect areas of damage may result in malfunction of the parachute and injury or loss of life to personnel.

Ripcord Assembly and Ejector Spring Test Requirements

The 14-pound and 27-pound ripcord testing will be conducted upon initial receipt. The 14-pound test will be conducted at every re-pack and is covered in the packing procedures. The 27-pound ripcord assembly testing is done on initial receipt and/or replacement of ripcord assembly or pack tray IAW WP 0072.

NOTE

The closing loop must be replaced at every re-pack regardless if this is an annual pack cycle or accidental deployment.

Assemble the Ejector Spring

NOTE

The test tube (PVC pipe) and the 32-pound weight constitute the spring compression test set. The spring compression test set is locally manufactured IAW WP 0084.

Perform a compression test during initial receipt, during each re-pack and each time the ejector spring is replaced. Allow the spring to remain in a relaxed state for up to 24 hours before testing.

1. Measure the reserve closing loop to ensure it is 12 inches \pm ¼-inch measured under hand tension.
2. Using the packing T-bar, route the reserve closing loop (Figure 2, Item 1) completely through the reserve closing loop channel (Figure 2, Item 2) located at the bottom of the ejector spring (Figure 2, Item 3).



Figure 2. Assembling the Ejector Spring.

PREPARING THE T-11 RESERVE FOR PROPER LAYOUT - CONTINUED

3. Ensure the ejector spring (Figure 3, Item 1) is positioned so that the reserve closing loop channel is against the top of the table. Compress the ejector spring (Figure 3, Item 1) using both hands on a solid surface then route the packing rod (Figure 3, Item 2) through the bottom locator tabs right to left (Figure 3, Item 3). Ensure top locator tabs (Figure 3, Item 4) are in-line with the reserve closing loop channel.
4. Place the closing loop (Figure 3, Item 5) from the bottom of the ejector spring through the top locator tabs (Figure 3, Item 4).
5. Place pull-up cords (Figure 3, Item 6) through each end of the closing loop.
6. Insert a temporary pin (Figure 3, Item 7) through the right closing loop (Figure 3, Item 8) and pull the left closing loop, clinching the temporary pin.
7. Preposition all applicable parachute components and packing aids in and around the lower lateral band of the reserve parachute so as not to interfere with gore folding (under table).

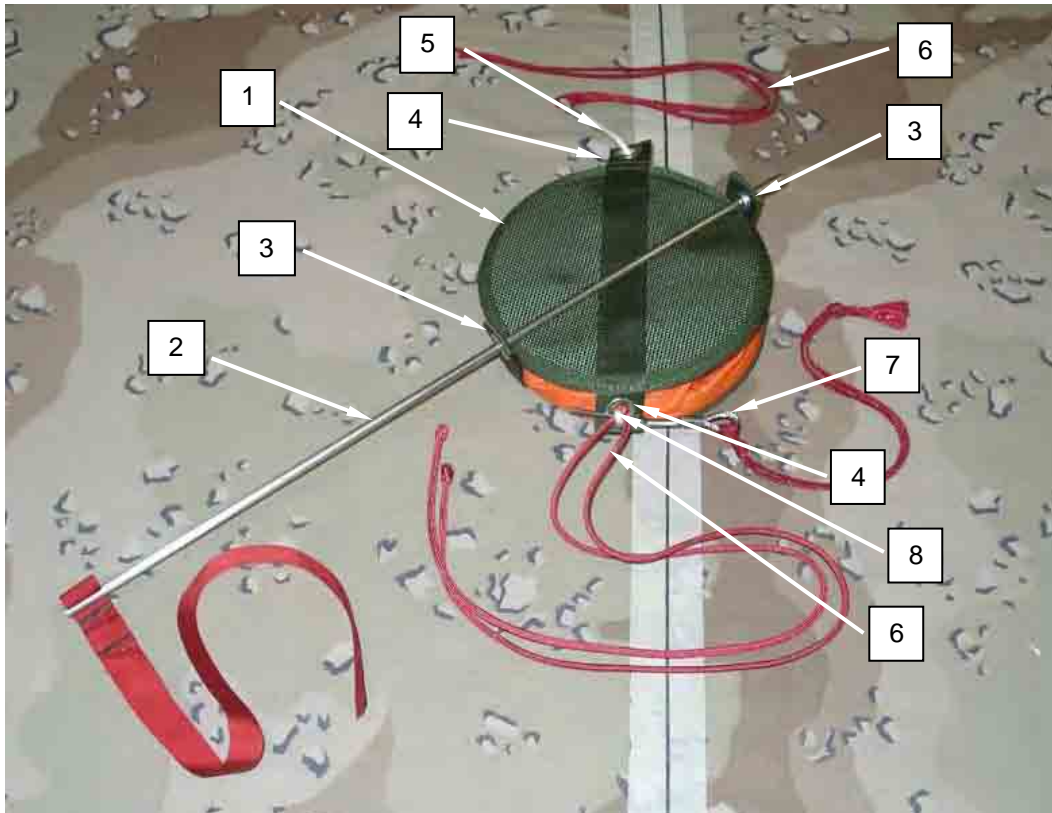

Figure 3. Prepare Ejector Spring.

END OF TASK

PREPARING THE T-11 RESERVE FOR PROPER LAYOUT - CONTINUED**Attach Apex to Table****NOTE**

A packing T-bar may be used to assist in routing of apex hook lanyard.

1. Working in a counterclockwise direction, pass the apex hook lanyard (Figure 4, Item 1) through all of the green and white loops (Figure 4, Item 2) at the apex.



Figure 4. Passing Apex Hook Lanyard through all Apex Loops.

2. Cut a 24-inch length of Ticket, 8/4 cotton thread (orange) (Figure 5, Item 1). Route one end through the loop of the apex hook lanyard (Figure 5, Item 2).
3. Attach running end of the apex hook lanyard to the apex hook (Figure 5, Item 3).

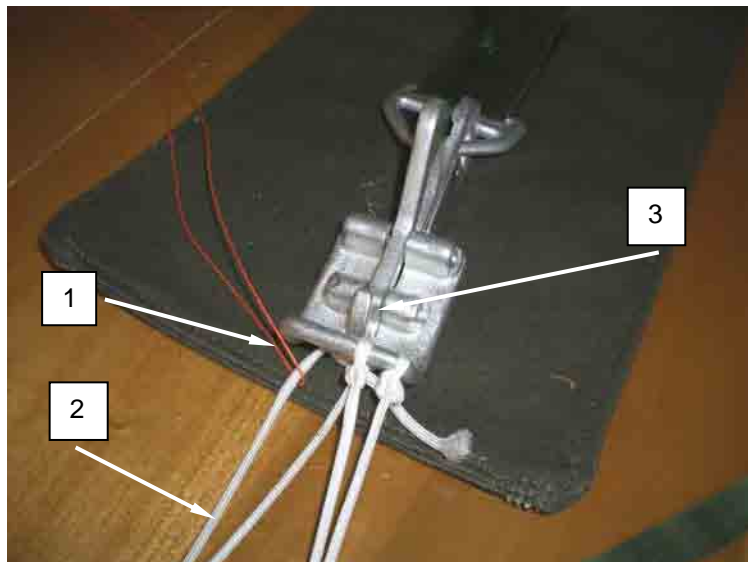

Figure 5. Routing the Ticket 8/4 Cotton Thread through Loop of Apex Hook Lanyard.

END OF TASK

PREPARING THE T-11 RESERVE FOR PROPER LAYOUT - CONTINUED**Lay Out the Canopy**

1. Place the reserve pack tray (Figure 6, Item 1) on the pack table with the reserve connector snaps (Figure 6, Item 2) at the lower end of the pack table and the connector links (Figure 6, Item 3) on the tension plate adapter (Figure 6, Item 4). Ensure the gates of the connector snaps are facing downward and the butterfly portions of the connector snaps are facing outward.

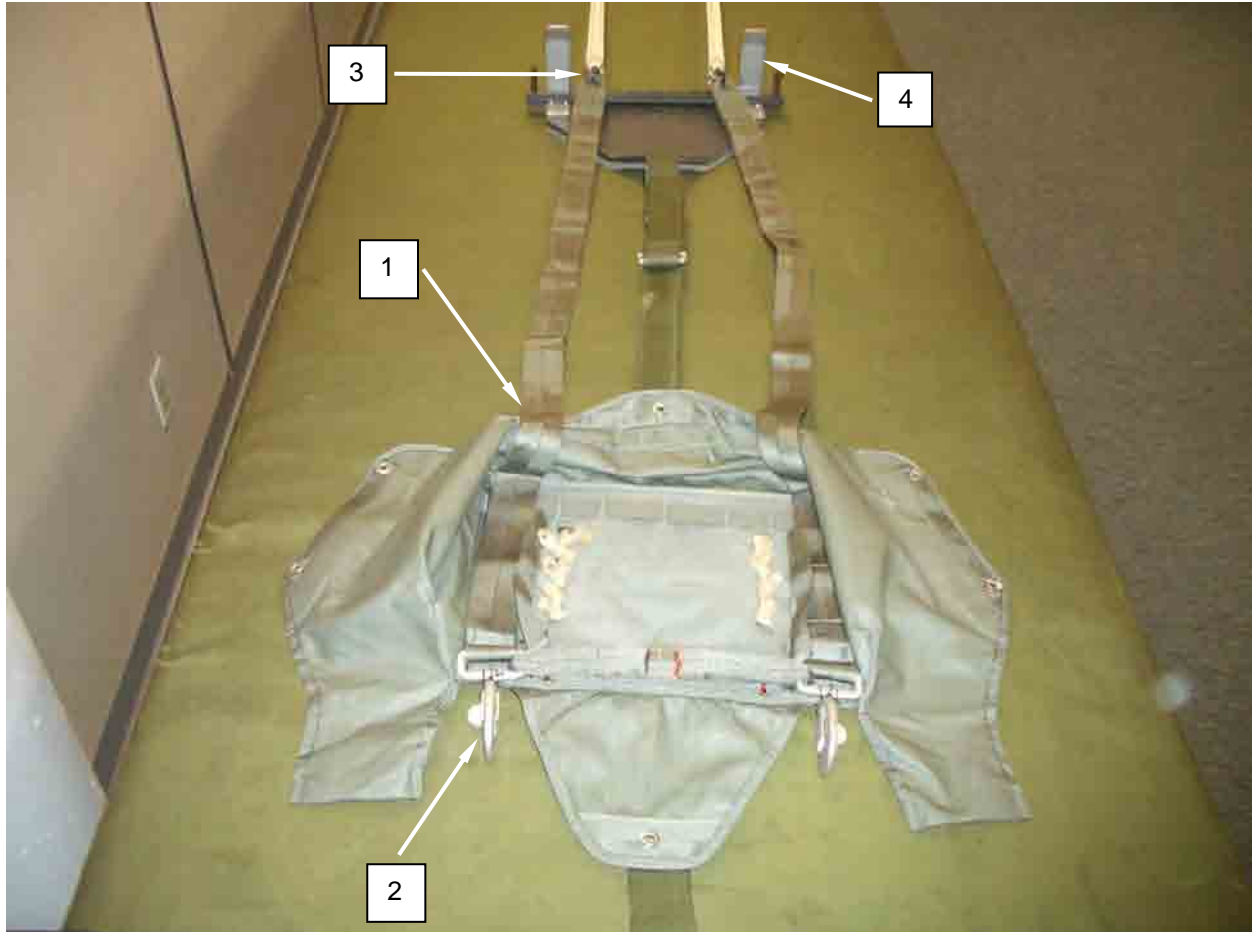

Figure 6. Placing Connector Links on Tension Plate Adapter.

PREPARING THE T-11 RESERVE FOR PROPER LAYOUT – CONTINUED

2. Inspect the risers (Figure 7, Item 1) to ensure they are tacked with lacing and tying tape, one turn doubled (Figure 7, Item 2) to prevent the barrel nuts of the connector links (Figure 7, Item 3) from rotating into the risers (Figure 7, Item 1). If lacing and tying tape is not present, refer to WP 0008.

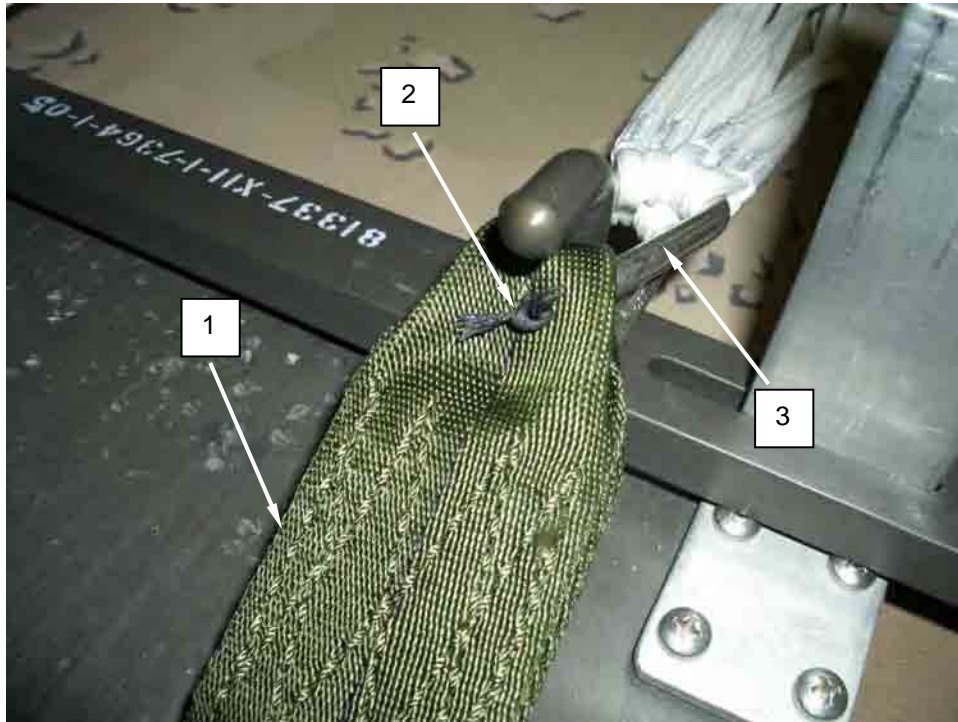

Figure 7. Inspecting the Risers.

3. Inspect the lacing and tying tape installed on the connector snaps. If it's not present, refer to WP 0008.

WARNING

Spreader bar attaching ties must be replaced at each annual repack. Failure to replace ties may result in malfunction of the parachute and injury or loss of life to personnel.

4. Cut two 10-inch pieces of Type III Nylon Cord, Guttled (Red) for the spreader bar attaching tie.

PREPARING THE T-11 RESERVE FOR PROPER LAYOUT – CONTINUED

5. Route a 10-inch pieced, type III nylon cord, (red/gutted) (Figure 8, Item 1) up through the lower grommet at the lower edge of pack tray (Figure 8, Item 2). Repeat for other side.

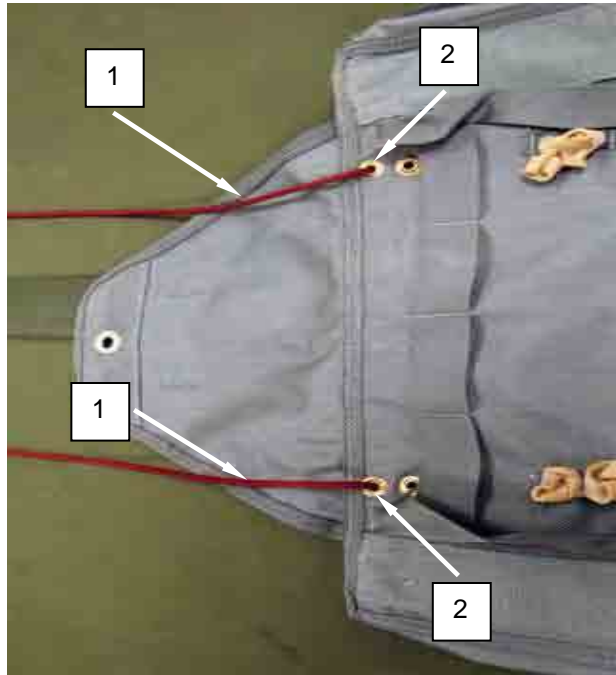

Figure 8. Routing Cord through Top Grommets of Pack Tray.

6. Center the spreader bar (Figure 9, Item 1) between the upper and lower grommets parallel to the lower edge of the pack tray.



Figure 9. Centering the Spreader Bar between the Upper and Lower Grommets.

PREPARING THE T-11 RESERVE FOR PROPER LAYOUT – CONTINUED

7. Route 10-inch piece of Type III Nylon Cord, Gutted (Red) (Figure 10, Item 1) over the spreader bar (Figure 10, Item 2) and down through the upper grommet (Figure 10, Item 3). Repeat for other side.

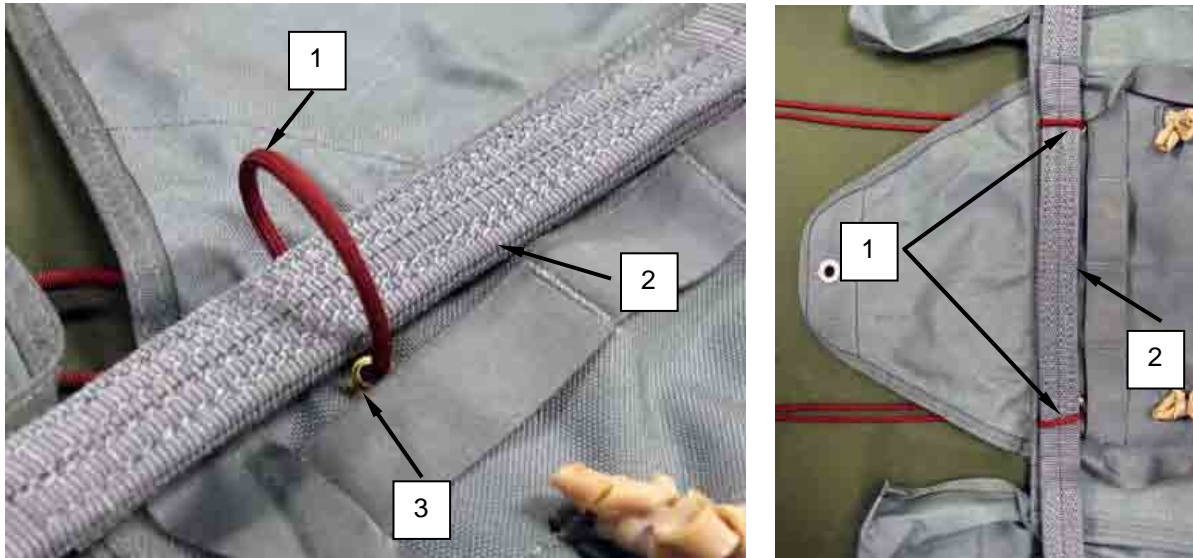

Figure 10. Routing Type III Nylon Cord Over Spreader Bar.

8. Secure the spreader bar on the back side of the pack tray by tying the Type III Nylon Cord, Gutted (Red) (Figure 11, Item 1) using a surgeon's knot locking knot (Figure 11, Item 2) with an overhand knot (Figure 11, Item 3) in the running ends. Trim running ends to 1 inch.

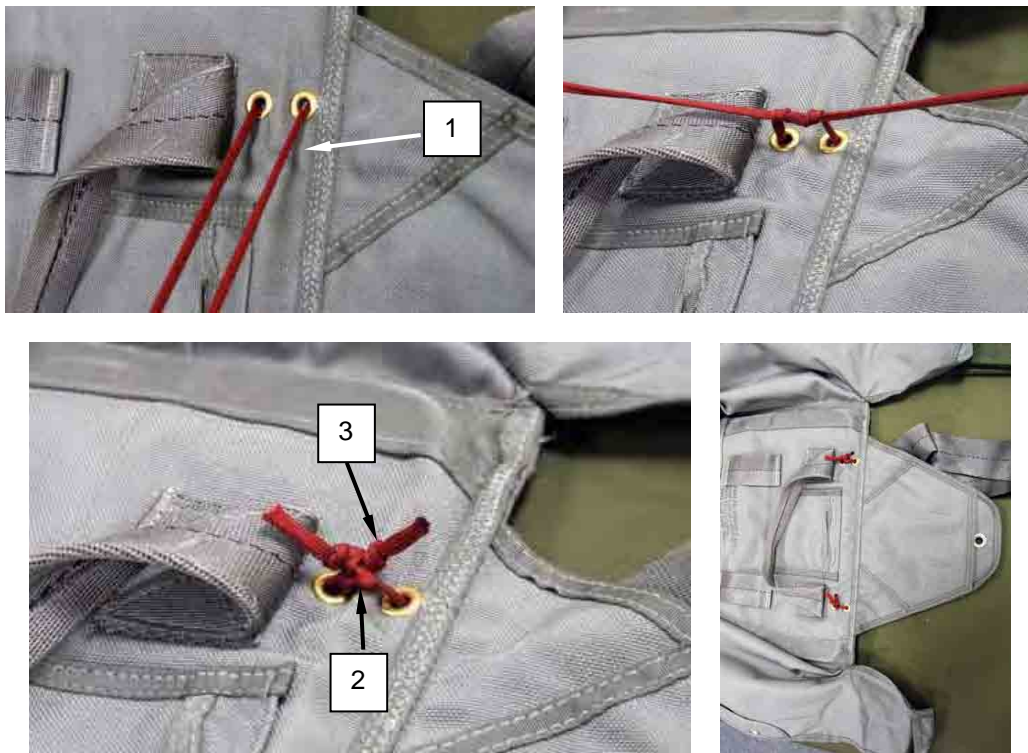

Figure 11. Securing the Spreader Bar on Back Side of Pack Tray.

PREPARING THE T-11 RESERVE FOR PROPER LAYOUT – CONTINUED

9. Place the pile tape on the riser to the hook tape on the pack tray. Ensure that the top bar (Figure 12, Item 1) of each snap hook aligns with the top of the binding tape (Figure 12, Item 2). S-fold the excess of the spreader bar (Figure 12, Item 3) back onto itself.

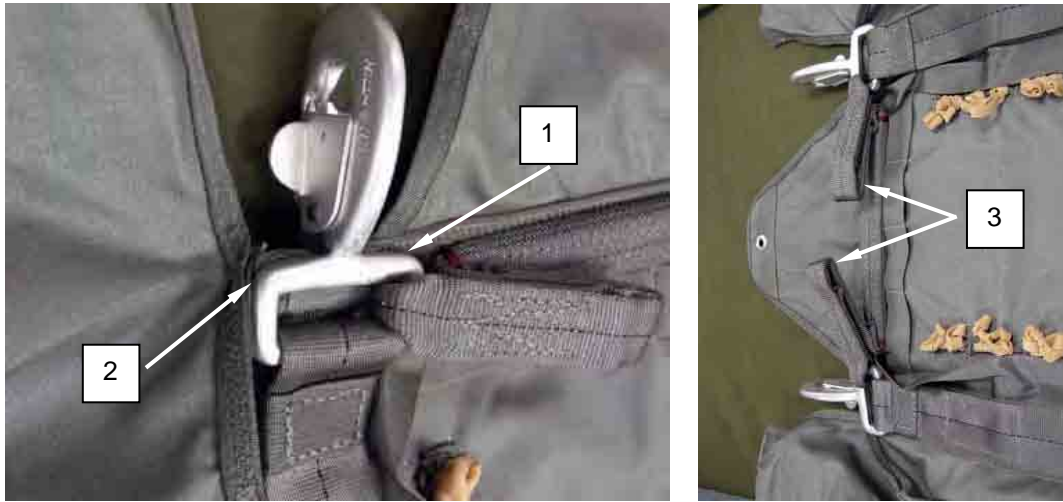

Figure 12. Aligning Top Bar of Snap Hook with Binding Tape and S-Folding Excess Spreader Bar.

10. Inspect tacking on connector snaps. If tacking is damaged, go to step 11. If tacking is not damaged go to step 18.

PREPARING THE T-11 RESERVE FOR PROPER LAYOUT – CONTINUED

11. Use an upholsterer's needle with a 24-inch piece of lacing and tying tape, one turn single, to attach the connector snap to the pack tray. Push the needle through the back of the pack tray, just below the binding tape, to the front in the middle of the connector snap (Figure 13).
12. Route the lacing tape around the throat of the connector snap.
13. Run the tacking needle through the front of the pack tray to the back of the pack tray.
14. Both running ends should now be on the back side of the pack tray.
15. Route the running ends over the pack tray around the throat of the connector snap, and tie a surgeon's knot locking knot. Trim the running ends to 1 inch.
16. Repeat for the second connector snap.



Figure 13. Securing Connector Snaps to Pack Tray.

PREPARING THE T-11 RESERVE FOR PROPER LAYOUT – CONTINUED

17. Using an 8-inch piece of ticket 8/4 cotton thread (orange), route from the left side to the right side in a clockwise direction between the plies of the excess fold-over from the spreader bar and back through the left side (Figure 14).
18. Tie a surgeon's knot locking knot. Loop should be approximately 2½- to 3-inches long. Ensure tie is secured tightly.

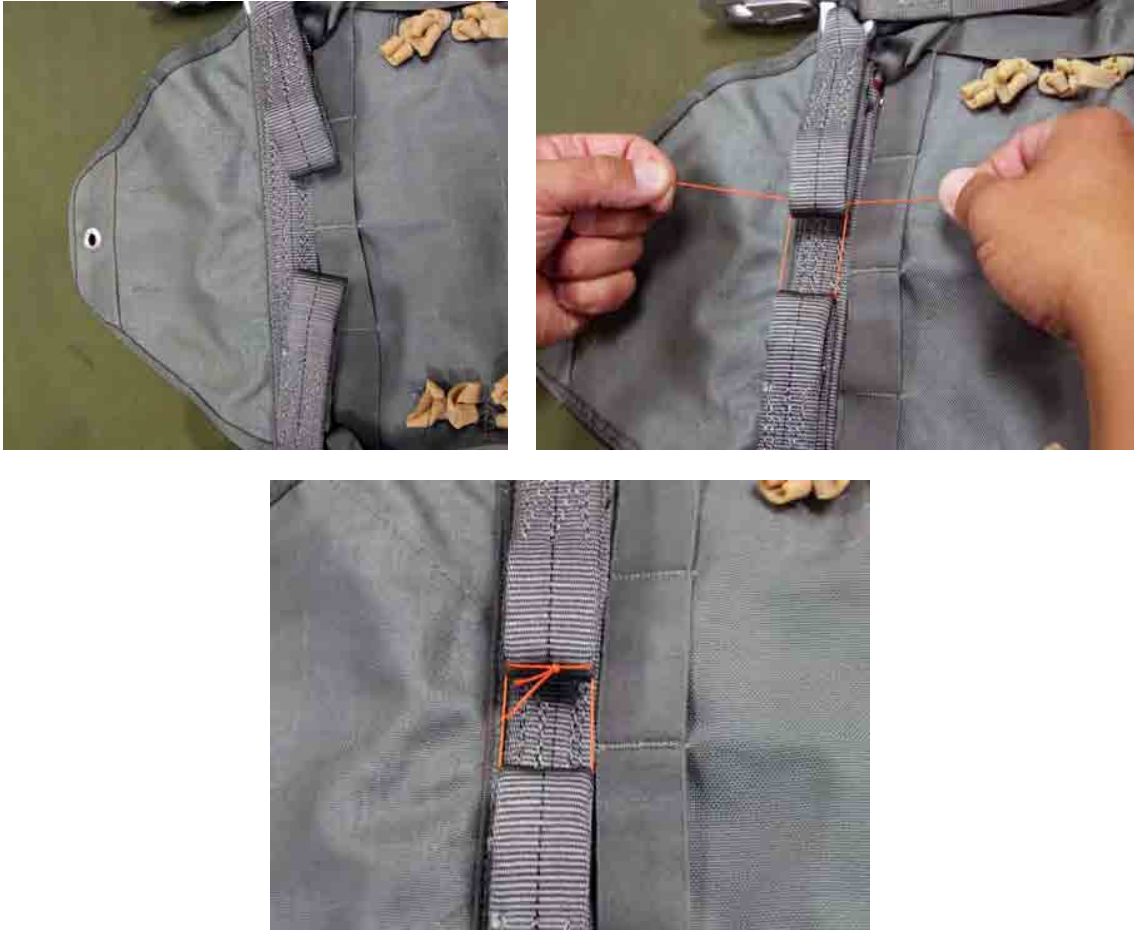

Figure 14. Securing the Excess Spreader bar Fold-over.

19. Tuck all flaps under pack tray.
20. Evenly mate the hook and pile tape between the reserve riser plies.

PREPARING THE T-11 RESERVE FOR PROPER LAYOUT – CONTINUED

21. Mate the pile tape on the underside of the riser (Figure 15, Item 1) to the hook tape on the base of the pack tray. Ensure the upper edge of the connector snap is aligned with the lower edge of the pack tray.
22. Make an S-fold in the left riser.

NOTE

Ensure nylon buffer and retainer bands are clear and all lower riser stows are placed over the spreader bar.

23. Make the first two riser stows by S-folding from upper to lower, outside to inside, then stow under each elastic riser stow bar (Figure 15, Item 3), flush with the edges of the pack tray.

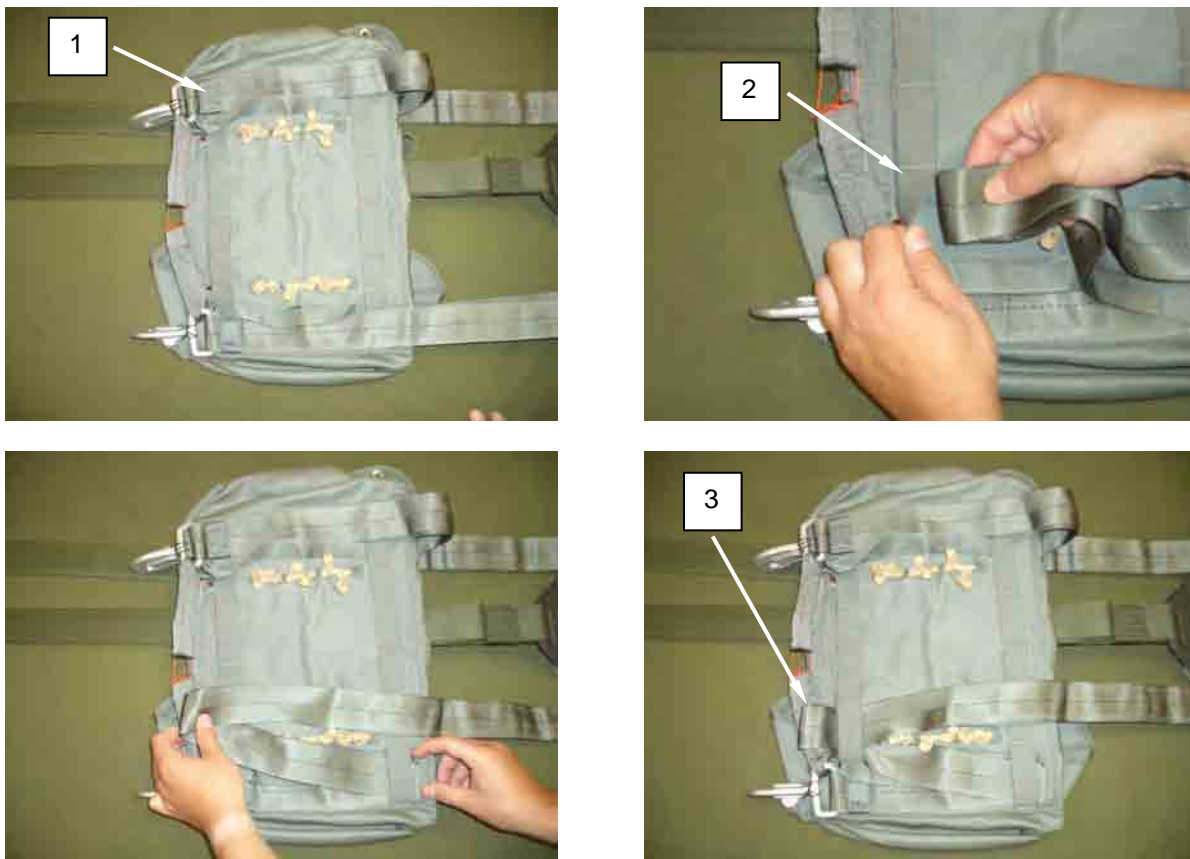

Figure 15. Partially S-Folding the Risers into Pack Tray.

END OF TASK

PREPARING THE T-11 RESERVE FOR PROPER LAYOUT – CONTINUED**Perform a Four Line Check**

1. Divide the suspension lines into the left and right groups. Lines 1-10 (Figure 16, Item 1) will be in the left group. Lines 11-20 (Figure 16, Item 2) will be in the right group. Ensure the suspension lines are free from turns, tangles and twists.

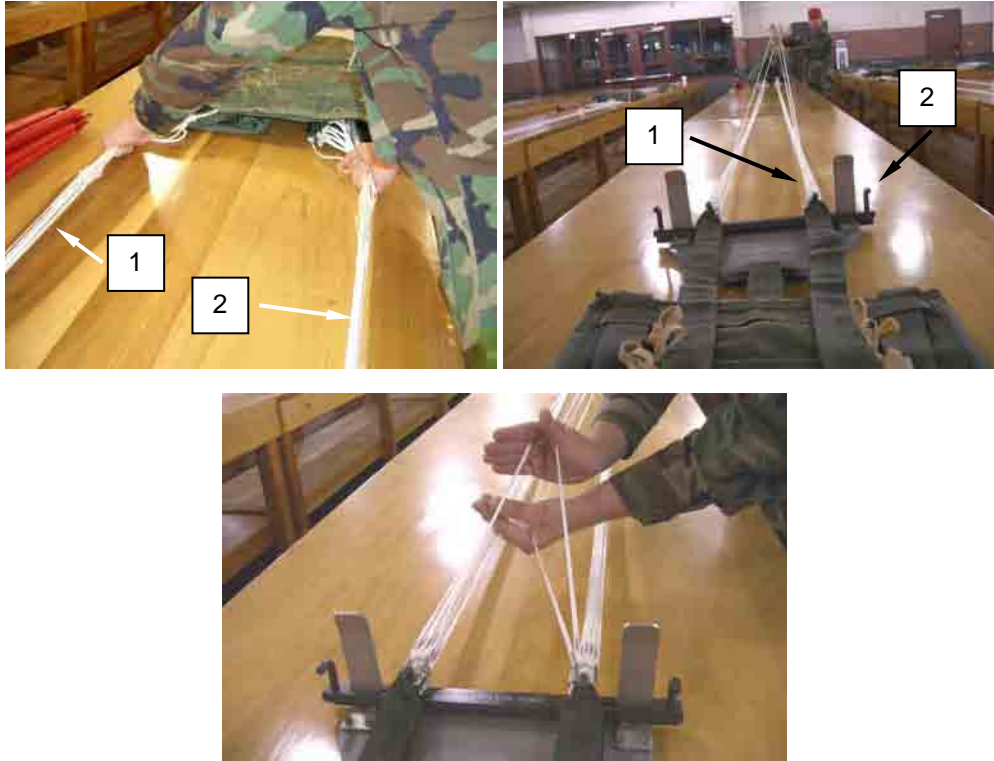

Figure 16. Performing a Four Line Check.

2. The left suspension line group will have line 1 on the inside of the top left connector link and line 10 on the inside of the bottom left connector link.
3. The right suspension line group will have line 20 on the inside of the top right connector link and line 11 on the inside of the bottom right connector link.
4. **Rigger Check Number 1.**

END OF TASK

FOLDING THE GORES

1. Preposition all applicable parachute components and packing aids in and around the lower lateral band of the reserve parachute so as not to interfere with gore folding (under table). Ensure all tools are prepositioned.
2. Apply first tension until suspension lines are taut and rise off the table being cautious not to break the skirt assist lines.
3. Move to the lower lateral band. With the right group of lines in the left hand, flip right group over left group.
4. Start with line 11 in the right hand (Figure 17, Item 1) at the lower lateral band, pick up line 12 (Figure 17, Item 2) with the left hand and pick straight up until slack is removed from the lower lateral band. With a brisk, smooth continuous movement, bring the left hand above the head. When the gore inflates, place line 12 on top of line 11. Make certain the gore material folds to the right side.



Figure 17. Folding Gores.

5. Continue folding the gores until you reach suspension line 10. Raise suspension line 10 and drape the last gore on left and the next to last gore on the right. Place suspension line 10 on top of the other lines in the left group.

FOLDING THE GORES - CONTINUED

6. Place canopy on table. Apply second tension.
7. Rough dress gore 10 from lower lateral band to within 24 inches of the apex. Placing the middle finger of the left hand between the two groups of suspension lines, flip left group of gores (top half) to left side of table tracing main seam 20 to the upper lateral band.
8. Place a packing weight on the suspension lines. Fine dress the bottom gores by pulling gently on the left and right sides of the canopy, moving from the lower lateral band to the upper lateral band.
9. Dress the top gores by pulling gently while moving to the lower lateral band. The canopy is now in a flat fold.

NOTE

Count gore edges to be sure that ten are in each group. Pay particular attention when dressing the canopy; ensure that the reinforcement tapes that are 4½-feet below the upper lateral band remain aligned.

10. Place the left group of gores 2 inches over the air channel.
11. Dress each gore from the lower lateral band to the scoops.
12. Repeat steps 10 and 11 for right side.
13. Remove packing weight.

FOLDING THE GORES - CONTINUED

14. Separate the two groups of lines (Figure 18) attached to the lower lateral band of the canopy (1-10 and 20-11) ensuring that the lines are not routed around the skirt assist lines. Ensure that the skirt assist lines run freely up into the folded canopy.

NOTE

Skirt assist lines are the lines going into canopy.

Although a line separator may be used, it is not required.

15. If using the line separator, place the skirt assist lines (Figure 18, Item 1) into the line separator (Figure 18, Item 2) with the suspension lines (Figure 18, Item 3) to the outside. If the line separator is not used, ensure that the lines are gathered together at the point where they enter the canopy opening (Figure 18, Item 4).
16. Place a packing weight on the suspension line immediately below the lower lateral band.

FOLDING THE GORES - CONTINUED

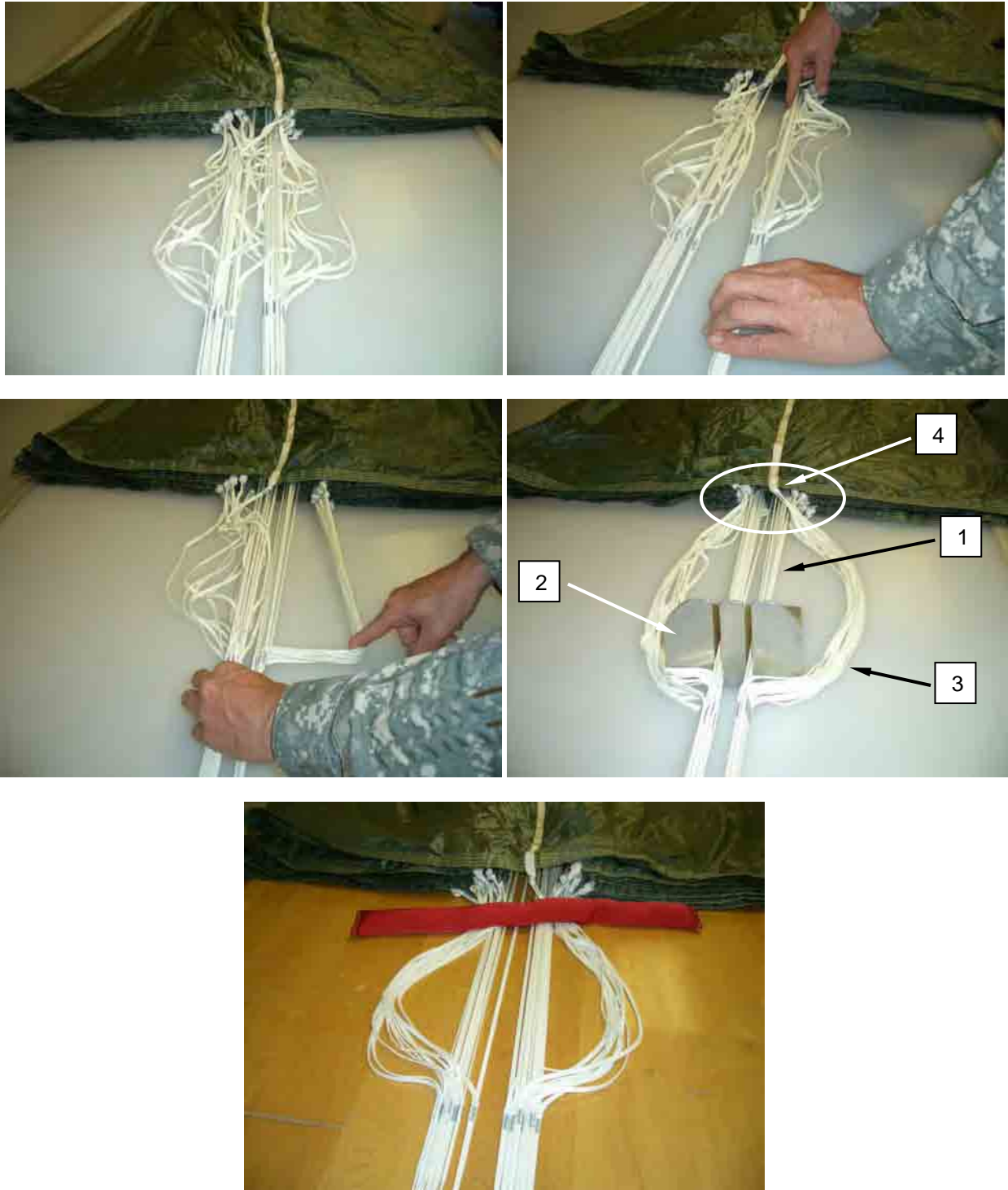

Figure 18. Organizing the Skirt Assist Lines Entering the Canopy.

END OF TASK

FOLDING THE GORES - CONTINUED**Tying the Apex Scoops**

1. Trace main seam 20 to the upper lateral band and locate the top scoop (Figure 19, Item 1) at the upper end of the canopy.
2. Dress the top, left, right, and bottom apex scoops. The top and bottom apex scoops are split evenly between the left and right sides of the folded canopy. The left and right scoops are dressed to their respective sides.



Figure 19. Folding and Dressing Left and Right Apex Scoops.

FOLDING THE GORES - CONTINUED

3. Cut four 12-inch lengths of Ticket 8/4 cotton thread (orange).
4. Follow the reinforcement tape attached to lower end top scoop to the left until the loop at the main seam is located.
5. Follow the reinforcement tape attached to the left scoop to the right until the loop at the main seam is located.
6. Ensure there is no material between the two loops.
7. Pass one length of Ticket 8/4 cotton thread (orange) down through the right loop and back up through the left loop.
8. Bring the two ends together and secure tightly with a surgeon's knot locking knot. Trim running ends to ½ inch.



Figure 20. Tying and Securing Apex Scoop Loop Ends.

9. Continue on the left side, locate the next two loops, and secure as in steps 4 through 8 above (Figure 21).



Figure 21. Securing Remaining Loops.

10. Continue on right side and repeat steps 4 through 8 until all four loops are secured.
11. Redress scoops.
12. **Rigger Check Number 2.**

END OF TASK

LONG FOLDING CANOPY AND FOLDING THE EXTRACTOR

1. Fold the canopy (Figure 22) at the lower lateral band 90 degrees from the left and right sides to the center forming a 45 degree outside fold.



Figure 22. Folding Canopy at Lower Lateral Band.

2. Fold the left side of the canopy (Figure 23, Item 1) two-thirds to the right (approximately 3 inches over the air channel). Ensure the suspension lines (Figure 23, Item 2) are centered. Place a packing weight (Figure 23, Item 3) on the lower lateral band.

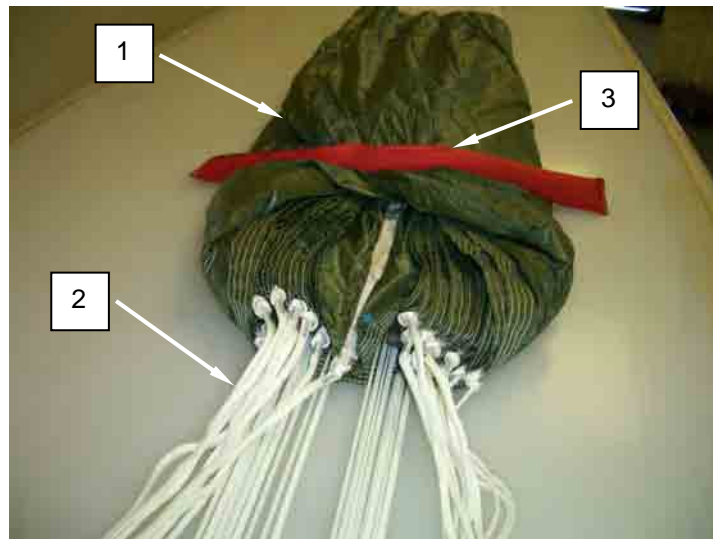

Figure 23. Folding Canopy Evenly into Thirds.

3. Continue folding the left group in the same manner until you reach halfway up the canopy and place a second packing weight.
4. Continue folding until you reach approximately 48 inches from the apex of the canopy and place the third packing weight.
5. Fold the right side of the canopy in the same manner, beginning at the lower lateral band folding it to the left. The canopy should be folded evenly into thirds.

LONG FOLDING CANOPY AND FOLDING THE EXTRACTOR - CONTINUED

6. S-fold the left and right sides of the top apex scoop to the center. S-fold the left top scoop first (Figure 24, item 1) folding to the center making folds no wider than the width of your hand (Figure 24, item 2).



Figure 24. S-Folding of the Top Left Side of the Apex Scoop.

7. S-fold the right top scoop in the same manner as the left top scoop (Figure 25, item 1).



Figure 25. S-Folding of the Top Right Side of the Apex Scoop.

8. S-fold the left scoop. Then the right scoop over the top scoop. Making folds no wider than the width of your hand.

LONG FOLDING CANOPY AND FOLDING THE EXTRACTOR - CONTINUED

9. S-fold the left side of the bottom scoop (Figure 26, item 1), then the right side of the bottom scoop (Figure 26, Item 2) over the previously folded scoops.

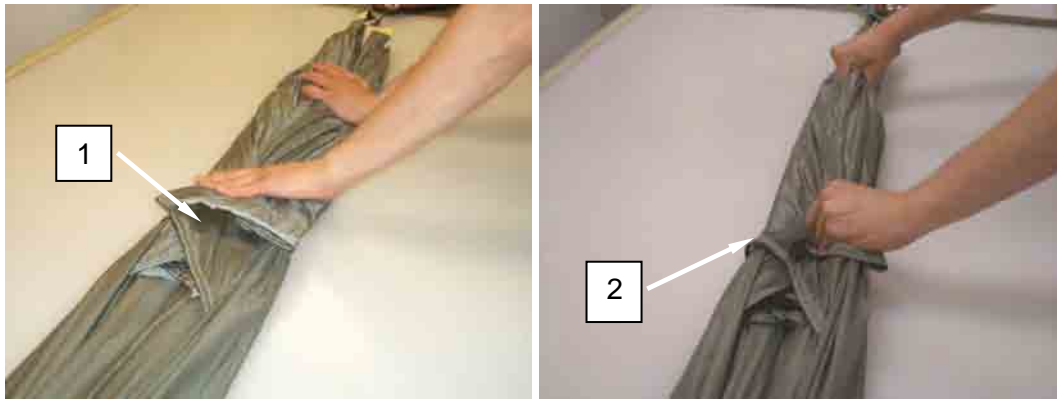

Figure 26. Folding Left and Right Apex Scoops and Complete Long Folding.

10. To complete the long fold, tightly fold the apex scoops (Figure 27, Item 1) in half and rotate folded scoops toward the left side of the table. Place a packing weight on top of the folded apex scoops (Figure 27, Item 2).

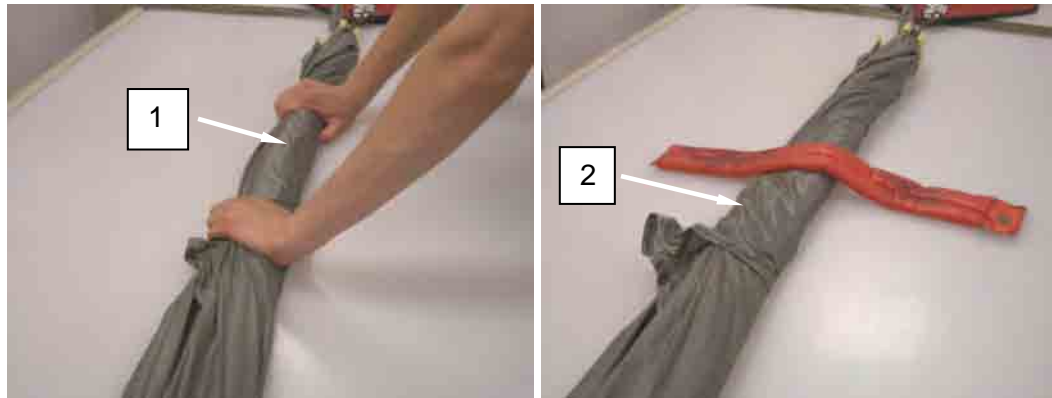

Figure 27. Folded Apex Scoops.

LONG FOLDING CANOPY AND FOLDING THE EXTRACTOR - CONTINUED

11. With the apex of the canopy attached to the table, perform a line check of the extractor by identifying the top or bottom line group (Figure 28, Item 1) and tracing it up to the extractor canopy. Ensure there are no turns, tangles, or twists.



Figure 28. Perform Line Check of the Extractor.

12. Apply hand tension to the lines and extractor canopy.

NOTE

When folding extractor canopy, ensure last gore is folded to make six even, taut folds.

13. Fold the extractor (Figure 29, Item 1) keeping the attachment lines (Figure 29, Item 2) centered evenly
14. Place the extractor on the table and evenly split the gores with six folds on each side.



Figure 29. Folding the Extractor.

LONG FOLDING CANOPY AND FOLDING THE EXTRACTOR - CONTINUED

15. Fold the left then the right side into the center, folding the canopy (Figure 30, Item 1) in thirds.

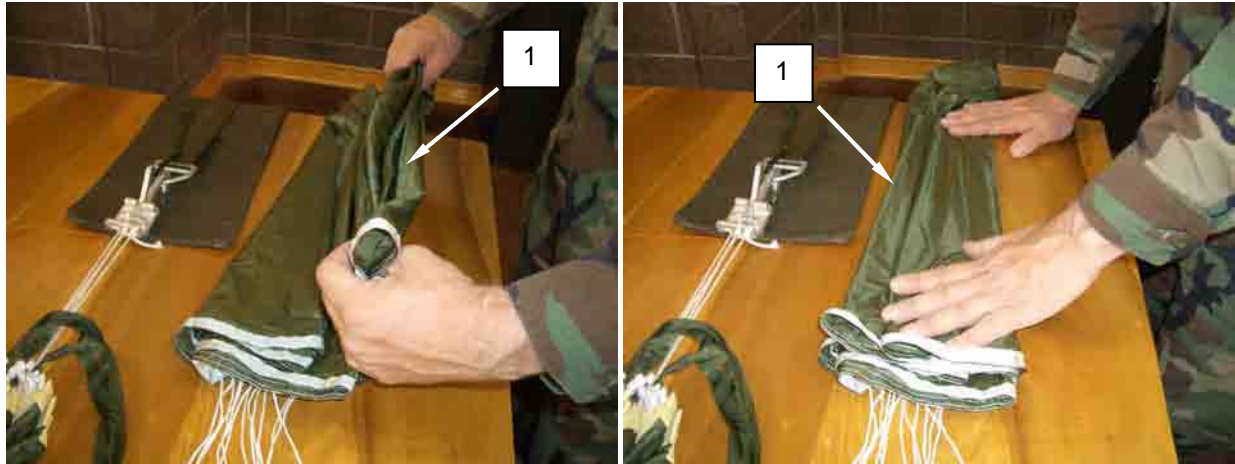

Figure 30. Folding the Extractor Canopy into Thirds.

16. S-fold the extractor (Figure 31, Item 1) in thirds, lengthwise from upper end to lower end of packing table.



Figure 31. S-Folding Extractor.

LONG FOLDING CANOPY AND FOLDING THE EXTRACTOR - CONTINUED

17. Place the extractor (Figure 32, Item 1) on top of the scoop area under a packing weight (Figure 32, Item 2).



Figure 32. Placing Extractor on Top of Apex Area.

18. Rigger Check Number 3.

END OF TASK

STOWING THE SUSPENSION LINES

1. Release tension. Remove connector links. Set tension device aside.

NOTE

Ensure nylon buffer and retainer bands are clear all lower riser stows are placed over the spreader bar.

The second and fifth upper elastic stow loops are not used.

2. Make two additional riser stows by S-folding the risers (Figure 33, Item 1) into the pack tray (Figure 33, Item 2) from upper to lower, outside to inside stowing fold under the elastic over stow bar, ensure the connector links (Figure 33, Item 3) are in the center of the pack tray.

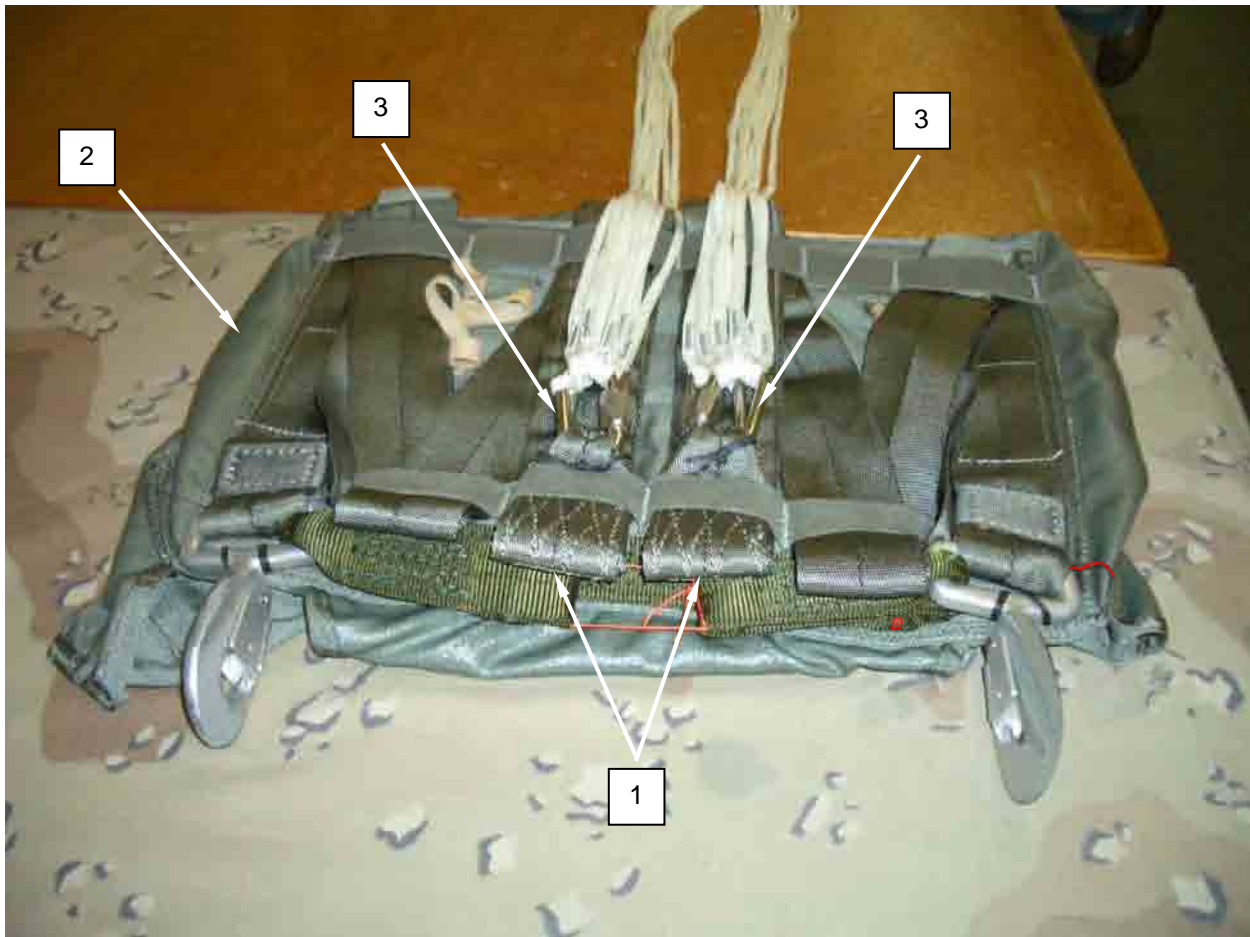

Figure 33. Making Two Remaining Riser Stows.

3. Rotate the container 90 degrees clockwise.

STOWING THE SUSPENSION LINES – CONTINUED**NOTE**

2-inch retainer bands (commonly known as large) will be used for stows attached to the pack tray. 1-¼ inch (commonly known as small) retainer bands will be used for the 2-inch “free” stows. All retainer band stows are single turn only.

4. Make the first stow (Figure 34, Item 1) to the upper right (rigger's view) of the pack tray. Ensure the stow (Figure 34, Item 1) extends to the edge of the pack tray (Figure 34, Item 2). Ensure the suspension lines (Figure 34, Item 3) remain in the center and the running ends of the lines towards the connector snaps.



Figure 34. Making First Regular Stow.

5. **Rigger Check Number 4.**
6. The second stow (Figure 35, Item 1) is to the upper left (rigger's view) of the pack tray.
7. Continue stowing until approximately 36 inches of suspension lines (Figure 35, Item 2) remain to the lower lateral band. There should be six stows per side attached to the stow bars of the container. Align all stows with the outer edge of the pack tray.

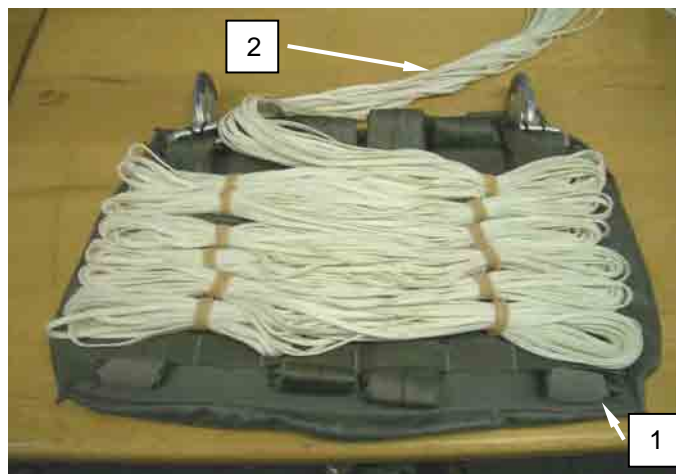

Figure 35. Continuing Regular Stows.

STOWING THE SUSPENSION LINES - CONTINUED

8. Three additional “free” stows (not attached to the pack tray) will be formed. The first two free stows will be aligned with the outer edge of the pack tray. The third will be in the center on top of the suspension lines.
9. Make the first free stow by forming a bight approximately 12 inches from the last stowed line and place a small retainer band (Figure 36, Item 1) 1 to 2 inches from the end of the bight.
10. Make the second free stow by forming another bight approximately the same distance and place another small retainer band (Figure 36, Item 2) in the same manner.



Figure 36. Forming Bight and Placing Retainer Band.

11. Remove the line separator, if applicable. Remove packing weight.

STOWING THE SUSPENSION LINES - CONTINUED

12. Form the last free stow by removing the slack from the suspension lines as follows:

- a. Grasp lines (Figure 37, Item 1) at lower lateral band and slide slack toward the bartack (Figure 37, Item 2) at the point where the lines cascade.

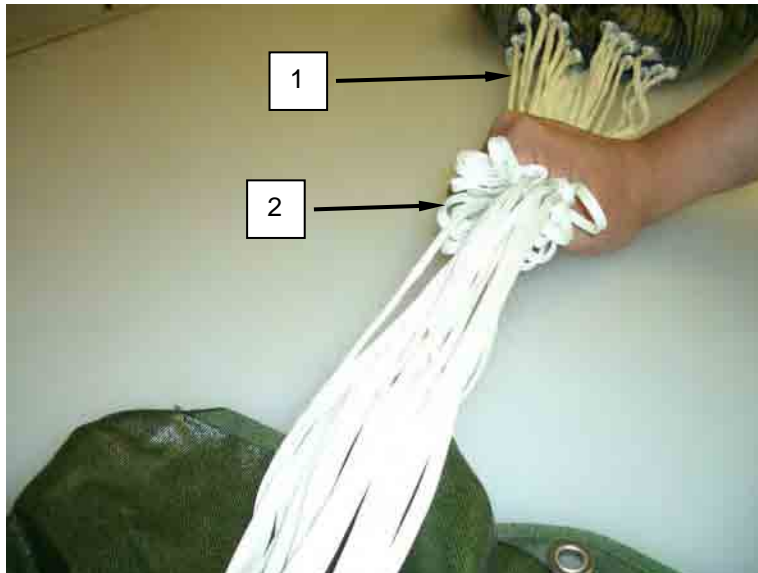
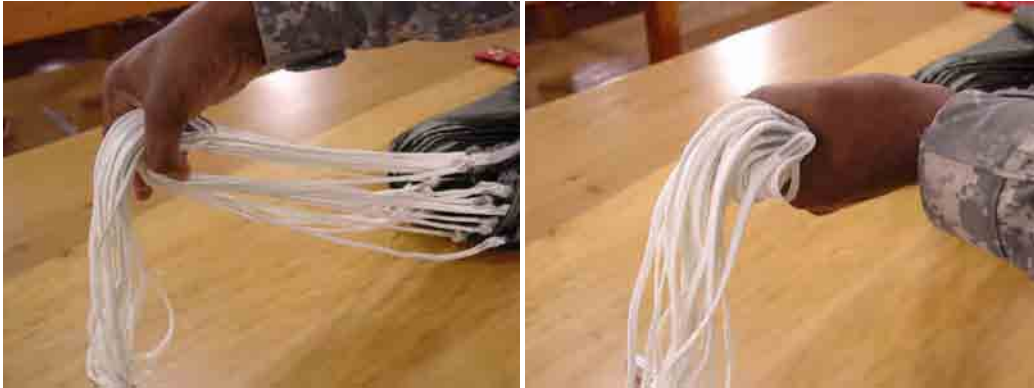

Figure 37. Grasping Lines and Removing Slack.

STOWING THE SUSPENSION LINES - CONTINUED

- b. Form a bight by folding the suspension lines under the skirt assist lines. Place a retaining band (Figure 38, Item 1) approximately 1 to 2 inches from the end of the bight (Figure 38, Item 2).



Figure 38. Making a Stow with Suspension Line Bight and Small Retainer Band.

- c. Place the last free stow (Figure 39, Item 1) of the suspension lines on top of the stowed lines in the center of the pack tray.



Figure 39. Placing Last Free Stow on top of Stowed Lines.

STOWING THE SUSPENSION LINES - CONTINUED

13. Route the Ticket 8/4 cotton thread (orange) through the loops of the upper lateral band as follows:

WARNING

Failure to make the apex tie may result in a malfunction causing serious injury or death.

- a. Release the apex hook (Figure 40, Item 1).

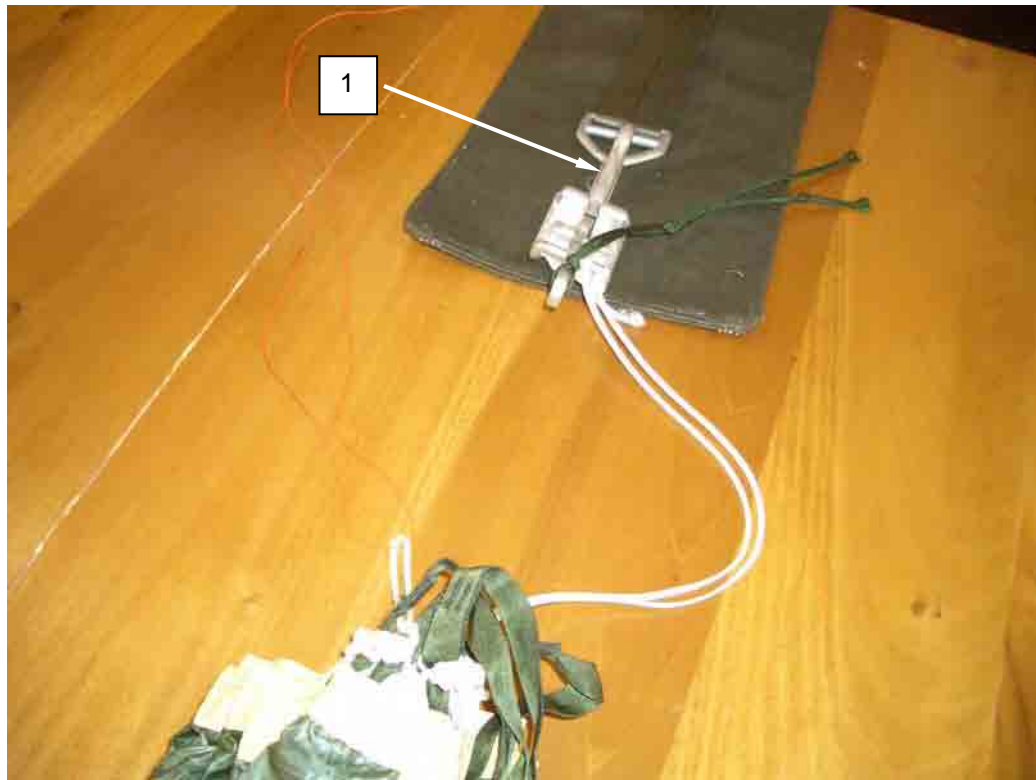

Figure 40. Releasing the Apex Hook.

STOWING THE SUSPENSION LINES - CONTINUED

- b. Carefully pull the apex hook lanyard (Figure 41, Item 1) through the apex loops (Figure 41, Item 2) so that the Ticket 8/4 cotton thread (orange) (Figure 41, Item 3) is laced through all of the apex loops.

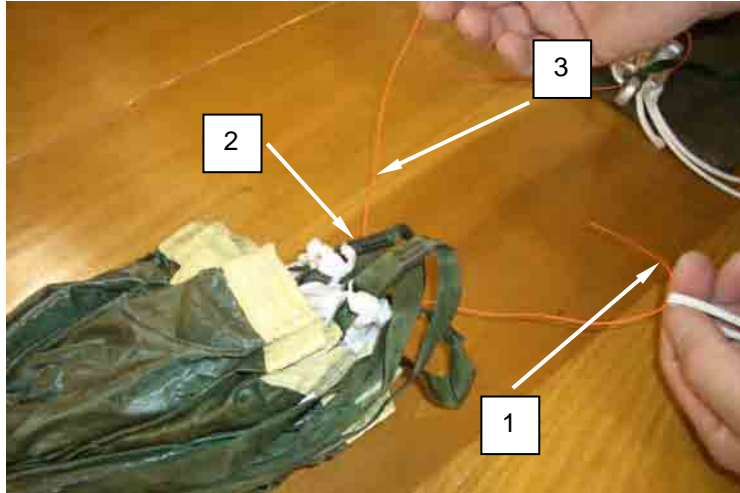

Figure 41. Pulling the Apex Hook Lanyard through the Apex Loops.

NOTE

Ensure that the extractor bridle is not caught in the tie.

- c. Tightly tie the two ends Ticket 8/4 cotton thread (orange) (Figure 42, Item 1) with a surgeon's knot locking knot.



Figure 42. Tying off Apex Loops.

- d. Trim the ends to ½ inch.

14. Rigger Check Number 5.

END OF TASK

FOLD THE CANOPY INTO THE PACK TRAY**NOTE**

All folds should be even with the upper end of the pack tray. This forms a wedge shape to the top of the container, fitting the pack tray shape.

First fold has a tendency to slide or shift. Be sure to maintain control. Dress the canopy in the pack tray to counter this.

1. Unfold the flaps from under the pack tray.
2. Place the canopy (Figure 43, Item 1) into the pack tray (Figure 43, Item 2) so that the lower lateral band is flush with the right side of the pack tray.



Figure 43. Placing Canopy into Pack Tray.

FOLD THE CANOPY INTO THE PACK TRAY - CONTINUED

3. Make the first S-fold (Figure 44, Item 1) the width of the reserve pack tray until the lateral seam (Figure 44, Item 2) at the bottom of the vent panel is centered.



Figure 44. Making First S-Fold.

4. Make the second S-fold (Figure 45, Item 1) the width of the reserve pack tray until the lateral seam (Figure 45, Item 2) at the top of the vent panel is even with the left edge of the pack tray.



Figure 45. Making Second S-Fold.

FOLD THE CANOPY INTO THE PACK TRAY - CONTINUED

5. Make two small folds (Figure 46, Item 1) on the left side approximately 4 inches wide. Add packing weight if necessary.



Figure 46. Making Two Intermediate S-Folds.

6. Place the compressed ejector spring (Figure 47, Item 1) in the center of the second S-fold (mesh panel) (Figure 47, Item 2) with the packing rod (Figure 47, Item 3) exiting the container from the upper right.



Figure 47. Placing Compressed Ejector Spring on Folded Canopy.

FOLD THE CANOPY INTO THE PACK TRAY - CONTINUED

7. Ensure pull-up cords (Figure 48, Item 1) are aligned with upper and lower closing flap grommets (Figure 48, Item 2).
8. Make one fold (Figure 48, Item 3) over the ejector spring. The right side of the fold should extend past the other folds approximately 6 inches.
9. Fold 4 inches under the top fold to form a bridge over the top of the ejector spring. Reposition packing weight if necessary.

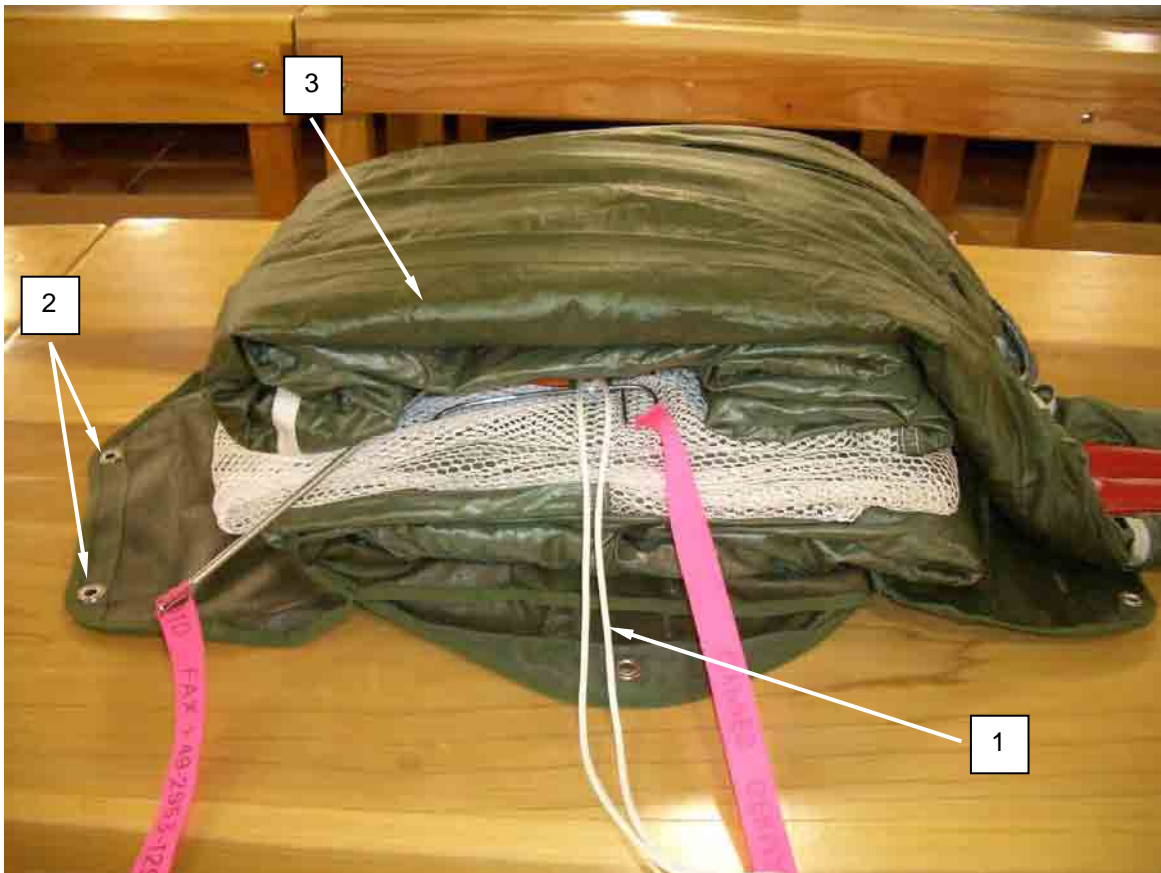

Figure 48. Forming a Bridge over Top of Ejector Spring.

FOLD THE CANOPY INTO THE PACK TRAY - CONTINUED

10. Remove the extractor from the top of the canopy and move off to the side.
11. Make three equal length folds (Figure 49, Item 1) centered over the ejector spring with the upper lateral band ending on the right side and bridle lines to the left (rigger's view).
12. Place a packing weight on top of the canopy.



Figure 49. S-Folding Remaining Canopy.

FOLD THE CANOPY INTO THE PACK TRAY - CONTINUED

13. S-fold the extractor lines (Figure 50, Item 1). Place the folded lines and extractor neatly on top of the canopy directly above the ejector spring.



Figure 50. S-Folding Extractor Attachment Lines.

14. Ensure extractor (Figure 51, Item 1) is centered on top of folded extractor lines with lower lateral band towards lower end of table. Place a packing weight on top of folded extractor.



Figure 51. Centering Extractor on top of Folded Canopy.

15. Rigger Check Number 6.

END OF TASK

CLOSING THE PACK TRAY**WARNING**

Utilizing a packing T-bar when closing the container is mandatory. Failure to use the T-bar can distort the folds in the canopy causing a malfunction, which may result in serious injury or death.

CAUTION

Align the pull-up cord on the solid portion of the shaft, not on the forked portion. Failure to comply will squeeze the fork together and render the tool useless or may cause breakage.

1. Thread the left (rigger's view) pull-up cord (Figure 52, Item 1) up through the lower grommet (Figure 52, Item 2) of the left side closing flap (Figure 52, Item 3) then up through the lower grommet (Figure 52, Item 4) on the right side closing flap (Figure 52, Item 5).



Figure 52. Placing Lower Pull-up Cord through Lower Grommet.

CLOSING THE PACK TRAY - CONTINUED

2. Remove packing weight. Pull up on the pull-up cord (Figure 53, Item 1) until the closing loop is exposed through the lower right side grommet and insert temporary pin.

NOTE

Ensure protection cap is positioned smooth side up.

3. Place protection cap (Figure 53, Item 1) over the extractor (Figure 53, Item 2).



Figure 53. Inserting Temporary Pin and Placing Protection Cap.

CLOSING THE PACK TRAY - CONTINUED**CAUTION**

When applying tension to T-bar, do not rest T-bar on grommet as damage can occur to grommets and/or stiffener.

4. Thread the right pull-up cord (Figure 54, Item 1) up through the upper grommet on the left side closing flap (rigger's view) (Figure 54, Item 2), then up through the upper grommet on the right side closing flap (Figure 54, Item 3). Thread the packing T-bar clockwise and apply tension three to five turns. Remove the temporary pin from the right closing loop (ejector spring temporary pin). Continue to apply tension utilizing the packing T-bar (Figure 54, Item 4) until the closing loop is exposed and insert temporary pin (Figure 54, Item 5).

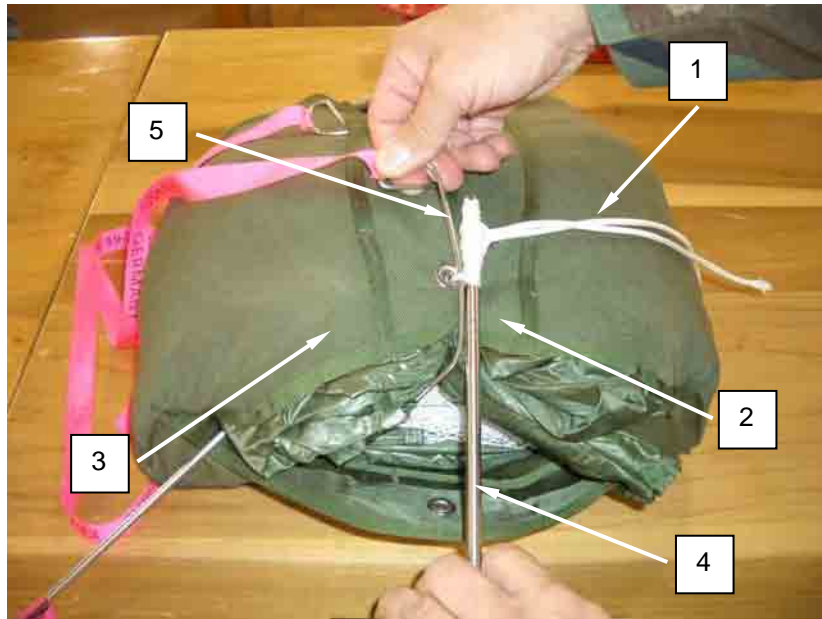

Figure 54. Exposing Closing Loops and Inserting Temporary Pin.

5. **Rigger Check Number 7.**
6. Remove the packing rod.
7. Stand pack tray on end with connector snaps facing up.

CLOSING THE PACK TRAY - CONTINUED

8. Tuck the left and right side closing flaps (Figure 55, Item 1) into the pack tray (Figure 55, Item 2) between suspension lines and risers.

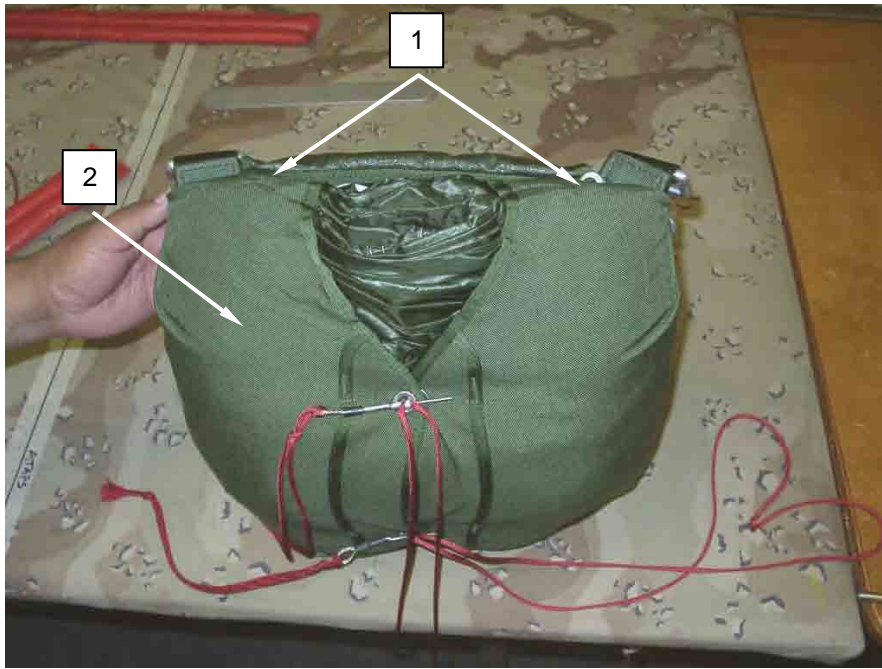

Figure 55. Tucking Left and Right Sides into Pack Tray.

9. Lay the pack tray (Figure 56, Item 1) down.
10. Thread the upper pull-up cord (Figure 56, Item 2) up through the upper flap grommet (rigger's view) (Figure 56, Item 3). Insert the pull-up cord in the packing T-bar (Figure 56, Item 4). Use the packing T-bar to apply tension by turning. Remove the temporary pin (Figure 56, Item 5). Continue to apply tension until the closing loop (Figure 56, Item 6) is exposed. Insert the temporary pin.

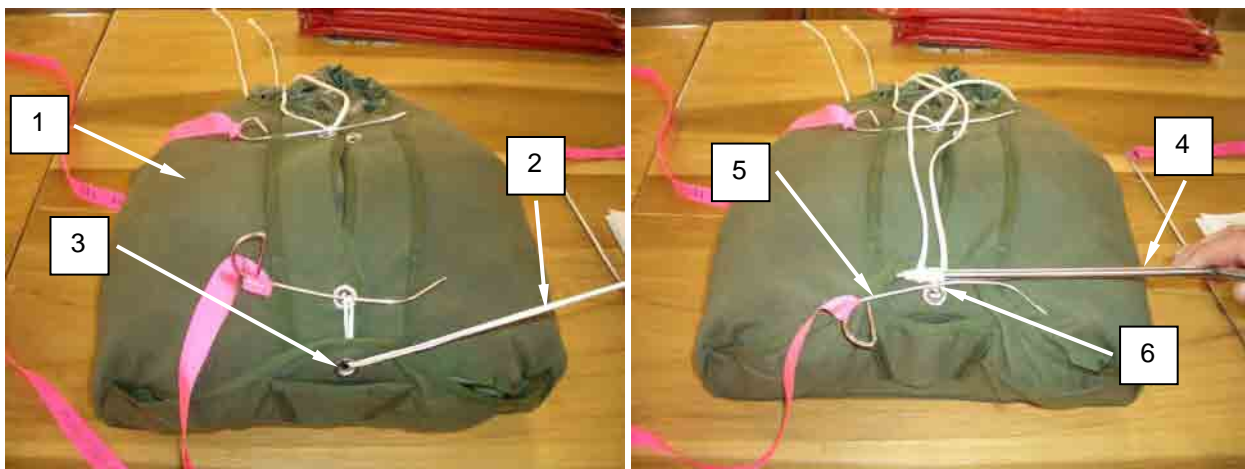

Figure 56. Using T-bar To Close Pack Tray and Inserting Temporary Pin.

CLOSING THE PACK TRAY – CONTINUED

11. Thread the lower pull-up cord (Figure 57, Item 1) up through the lower flap grommet (rigger's view) (Figure 57, Item 2). Insert the pull-up cord into the packing T-bar (Figure 57, Item 3). Use the packing T-bar to apply tension by turning. Remove the temporary pin (Figure 57, Item 4). Continue to apply tension with the packing T-bar until the closing loop (Figure 57, Item 5) is exposed and insert temporary pin (Figure 57, Item 4).

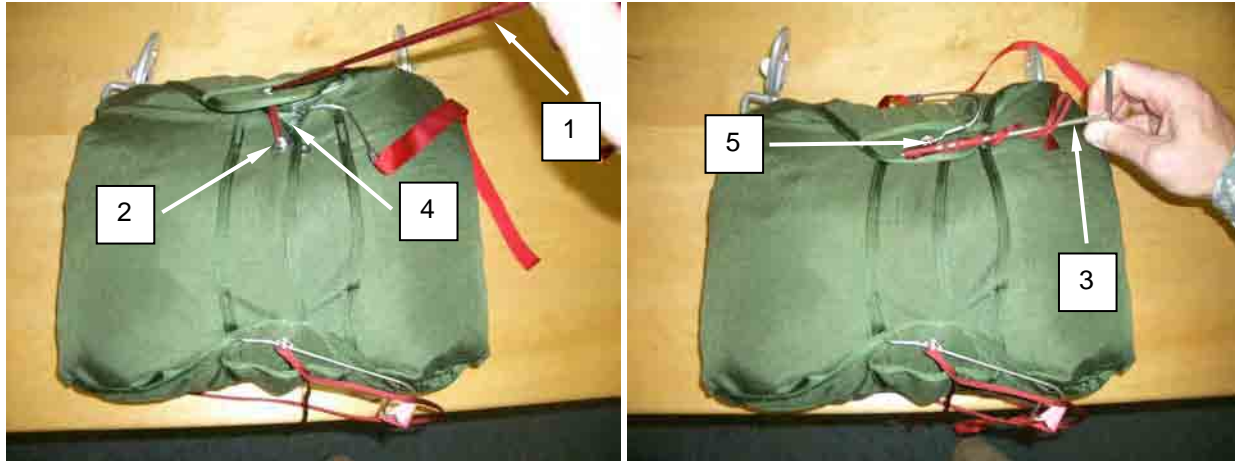

Figure 57. Inserting Second Temporary Pin.

CAUTION

Do not insert packing paddle into left and right tuck tab pockets as this may prevent proper fit of ripcord assembly tuck tabs.

12. Dress the pack tray.

CLOSING THE PACK TRAY – CONTINUED**NOTE**

If packing with new ripcord assembly, perform 27-pound pull test IAW WP 0072.

13. Position the ripcord assembly (Figure 58, Item 1) with the arrow pointing to the carrying handle (Figure 53, Item 2).
14. Insert the right tuck tab (Figure 58, Item 3) into the right tuck tab pocket.

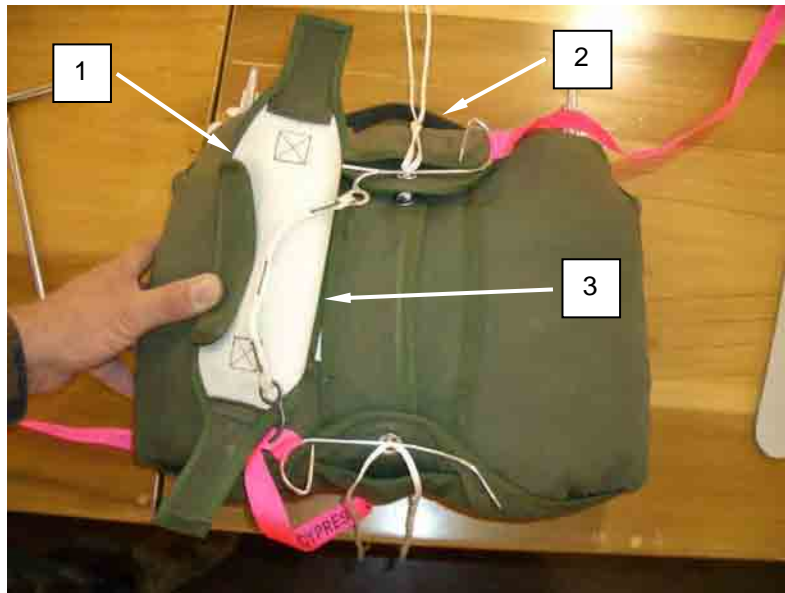

Figure 58. Inserting Right Tuck Tab into Right Tuck Tab Pocket.

15. Apply tension to the lower pull-up cord (Figure 59, Item 1) using the packing T-bar. Leave the temporary pin in place and insert lower-curved pin (Figure 59, Item 2) counterclockwise through closing loop against the grommet.

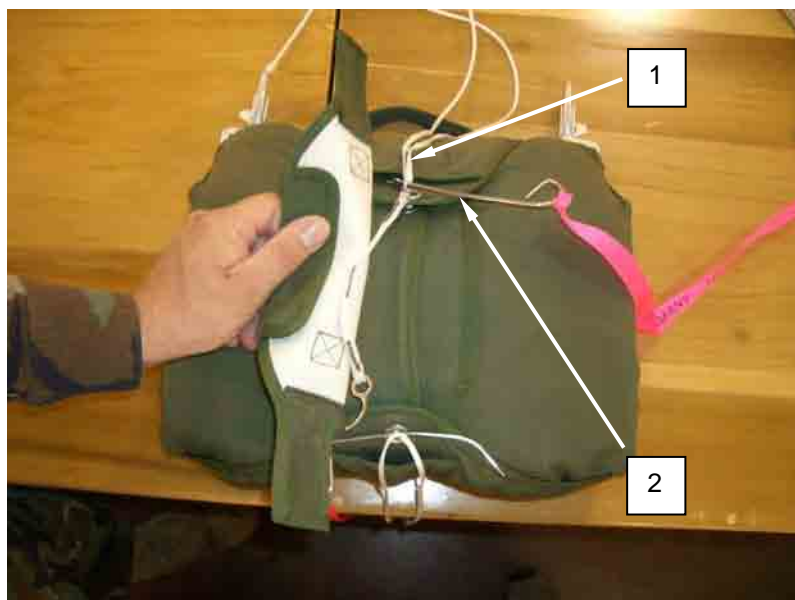

Figure 59. Inserting Lower-Curved Pin through Closing Loop.

CLOSING THE PACK TRAY – CONTINUED

16. Apply tension to upper pull-up cord (Figure 60, Item 1). Leave temporary pin in place and insert upper curved pin (Figure 60, Item 2) counter-clockwise through closing loop.



Figure 60. Inserting Top Curved Pin through Closing Loop.

17. **Rigger Check Number 8.**

WARNING

All packing aids must be accounted for after completion of packing. Failure to account for all packing aids could result in a malfunction causing serious injury or death.

18. Insert left tuck tab (Figure 61, Item 1) into left tuck tab pocket (Figure 61, Item 2).

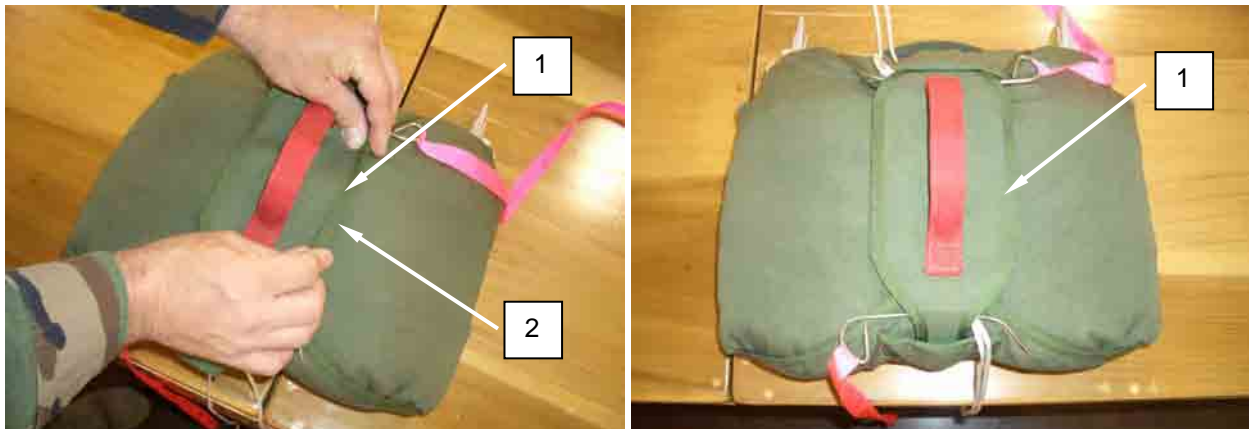

Figure 61. Inserting Left Tuck Tab into Left Tuck Tab Pocket.

19. Insert upper and lower tuck tabs into upper and lower tuck tab pockets.
20. Dress pack tray with packing paddle and inspect.

CLOSING THE PACK TRAY – CONTINUED**NOTE**

A 27-pound ripcord pull test shall be performed upon initial receipt of a new T-11 Personnel Parachute System, a new T-11 Reserve Assembly, or a new reserve ripcord assembly.

21. If required, perform a 27-Pound ripcord pull test IAW WP 0072.
22. Conduct a 14-Pound Minimum Ripcord Pull Test:

WARNING

Do not stand directly underneath the T-11 Reserve, in the event of accidental activation. Being hit by the ejector spring may cause severe injury. Stand off to one side of the T-11 Reserve when conducting both the 14-pound and 27-pound pull test.

NOTE

Use of a locally fabricated handle cuff is required. Fabricate a fabric cuff IAW WP 0084 entitled "Illustrated List of Manufactured Items".

A suggested method to ensure sufficient clearance beneath the horizontally suspended T-11 Reserve to conduct this test is to place two pack tables end to end with approximately 18 inches between them. Place the reserve parachute on top of the pack table centered over the gap. If available, a packing cradle may be used.

To conduct the T-11 Reserve ripcord pull tests, the packed T-11 Reserve shall be face down on the top of the packing table to allow the parachute to be deployed in a downward direction. There must be sufficient clearance beneath the horizontally suspended T-11 Reserve to suspend a weight from the ripcord handle and allow it to withdraw the ripcord pins from the soft loops activating the parachute.

The pull force exerted upon the handle must be uniformly distributed along the length of the handle. The handle cuff may be fabricated by using lightweight cotton duck material cut to 4 inches by 6 inches in size with two ½-inch holes spaced evenly so they will be below the handle when the material is folded in half around the handle.

- a. Place the handle cuff over the T-11 Reserve ripcord handle so that the grommets are below the handle and centered.
- b. While standing at the pack frame with the T-11 Reserve positioned for the pull test, carefully attach a 14-pound weight to the ripcord handle cuff and very slowly remove your hand from under the weight to allow the weight to be slowly transferred to the ripcord grip. Do not release the weight suddenly or let it drop since this will invalidate the test. The weight must not completely withdraw the ripcord pins from the soft loops or the ripcord handle completely from the pack tray.
- c. If the 14-pound weight causes complete withdrawal of the ripcord pins and the ripcord handle, conduct a retest. The retest must be performed five times. Conduct a retest by repacking the T-11 Reserve IAW this work package and repeat step a.

CLOSING THE PACK TRAY – CONTINUED

- d. Upon completion of the retest (five iterations), if the 14-pound weight does not withdraw the ripcord pins and ripcord handle from the T-11 Reserve each of the five times, it passes the 14-pound ripcord pull test.
 - e. If, during any one of the five retest iterations, the 14-pound weight causes complete withdrawal of the ripcord pins and the ripcord handle, then remove the T-11 Reserve assembly, replacement pack tray or ripcord handle (whichever is applicable), from service and follow instructions in step f below.
 - f. If the pack tray and ripcord handle are new (i.e. part of a T-11 Reserve assembly), or a new replacement pack tray or handle, submit an Standard Form (SF) 368, Product Quality Deficiency Report (PQDR) for the new items.
 - g. Annotate completion of this test (test conducted, name of tester, date completed) on the Notes page of the parachute log record book (DA Form 3912).
23. Once the 14-pound ripcord pull test has been passed, remove the temporary pins and remove pull-up cords (Figure 62, Item 1) by routing cords under curved pins and slowly pulling them under the pin.



Figure 62. Removing the Pull-up Cords.

24. Reinsert ripcord assembly tuck tabs (Figure 62, Item 2) in tuck tab pockets and re-dress pack tray, as needed.

END OF TASK

COMPLETING THE PARACHUTE LOG RECORD

Beginning with the initial packing of a parachute, and each time a parachute is repacked, the log record must be completed, as follows:

1. Remove the log record (Figure 63, Item 1) from the parachute inspection data pocket (log record pocket) (Figure 63, Item 1) located on the back of the reserve pack tray.

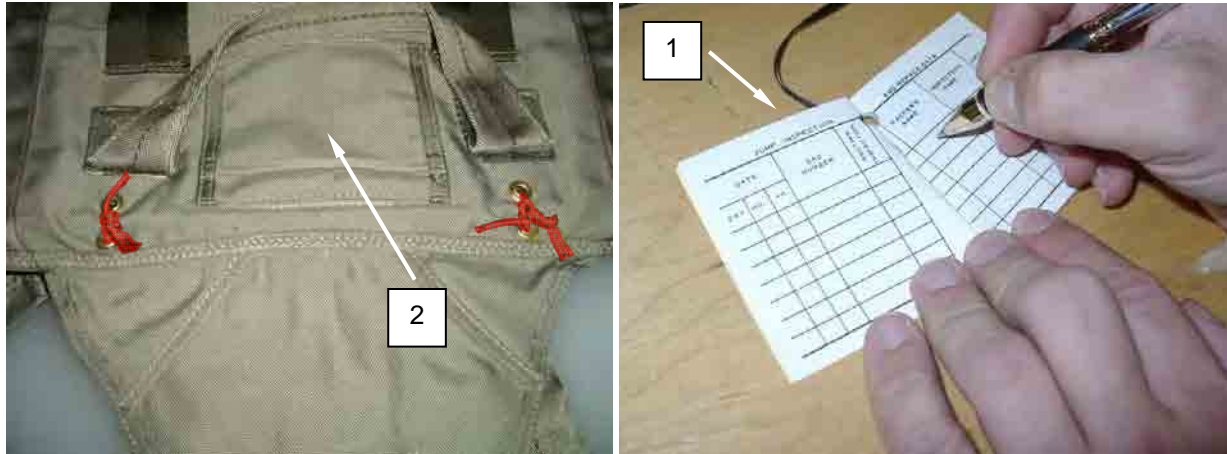

Figure 63. Completing Log Record.

2. Make entries on the JUMP, INSPECTION AND REPACK DATA page, as follows:
 - a. Date. Enter the day, month, and year of each packing action.
 - b. Bag Number. Pass/Fail 14 lb. ripcord test.
 - c. Routine inspection. No entry required.
 - d. Repack. For initial packing, enter IN; thereafter, enter a checkmark in the column each time the parachute is packed.
 - e. Packer's name. The packer performing the packing will sign this entry.
 - f. Inspector's name. The inspector who has performed the pack-in-process inspection will sign this entry.
 - g. Unit. Enter the unit designation to which the packer and/or inspector is assigned.
3. Return the log record to the log record pocket upon completion of the entries. Packing is now completed.
4. **Rigger Check Number 9.**

END OF TASK

END OF WORK PACKAGE

FIELD MAINTENANCE

GENERAL PARACHUTE REPAIR

INITIAL SETUP:

Tools and Special Tools

Specified in paragraph applicable to the item being repaired.

Personnel Required

Parachute Rigger 92R1P (1)
Parachute Rigger 92R2P (1)

Materials/Parts

Specified in paragraph applicable to the item being repaired.

References

WP 0018
WP 0019

Equipment Condition

Parachute unpacked and clean.
Canopy with defects recorded.

GENERAL PARACHUTE REPAIR

CAUTION

Stitch removal requirements will vary according to the type of item being repaired. Due to the unique type of stitch formations found on the T-11 Personnel Parachute System use of a stitch removal tool is mandated when removing Bartack, Box X, or Double Box X stitch formations.

NOTE

Log record entry is required for all maintenance actions. Sewing requirements will vary according to the type of item being repaired and the type of repair being made. The type of sewing machine, type of thread, the stitch range, and the stitch pattern (if applicable) required to accomplish a sewing procedure will be specified in the paragraph applicable to the item being repaired. All original stitching that is cut during the performance of a sewing procedure will be removed from the applicable item. Immediately after the accomplishment of a machine sewing procedure, trim thread ends to a point as close as possible to the material that has been sewn.

Repair and replacement of parachute components is performed in accordance with the repair instruction in this section and in specific paragraphs applicable to the item being repaired. Fabrication is a means of replacing an air delivery item component that is damaged beyond repair and not an issue item. Though the act of fabrication is a replacement-type action, the function is actually a method of repairing an end item. Since most fabrication pertains to components that are peculiar to parachutes, the fabrication of components that are most general in nature will be detailed in the following paragraphs.

Basting and Temporary Tacking

Basting and temporary tacking are hand-sewing methods used to temporarily hold layers of cloth fabric together while a repair is being performed. The following is a list of procedures that apply to basting and temporary tacking actions:

1. Basting and temporary tacking should be made using thread that is of a contrasting color to the material being worked.

GENERAL PARACHUTE REPAIR – CONTINUED

2. Basting and temporary tacking will be performed using a single strand of size A, nylon thread, or ticket No. 24/4 cotton thread.
3. When basting, do not tie knots at any point in the thread length. Also, the sewing should be made with two stitches per inch.
4. Immediately upon completion of a repair, remove previously made basting or temporary tacking.

END OF TASK**Basting Using a T-Pin**

T-Pin basting is the recommended method to use when conducting patch work or panel replacements on the T-11.

T-Pins will be placed into the canopy material to patch or replacement panel in place.

Ensure enough T-Pins are used to keep the replacement material or replacement panel securely in place prior to sewing.

WARNING

Ensure T-Pins are removed during the sewing process. Failure to do so may damage fabric, sewing machine, or cause injury to personnel.

All T-Pins are placed into the canopy material in the same direction, this will allow for easy removal during sewing.

Stitching and Re-stitching

Perform stitching and re-stitching as follows, refer to Tables 1, 2 and 3.

Parachute Canopy Assemblies. The stitching and re-stitching made on parachute canopies should be accomplished with thread that is contrasting in color to the fabric being re-stitched. If contrasting color thread is not available, thread of matching color may be used, providing all other specifications are met. Straight stitching and re-stitching on parachute canopy assemblies should be locked by at least 2 inches at each end of a stitch row, when possible. Zig-Zag stitching does not require locking; however, zig-zag re-stitching should extend at least $\frac{1}{4}$ inch into undamaged stitching at each end, when possible. When re-stitching parachute canopy assemblies, stitch directly over the original stitching and follow the original stitch pattern as closely as possible.

GENERAL PARACHUTE REPAIR – CONTINUED

Table 1. Recommended Sewing Machine Code Symbols.

CODE SYMBOL	SEWING MACHINE
LD	SEWING MACHINE, INDUSTRIAL: General Sewing; 301 Stitch; Light Duty; NSN 350-01-177-8590.
MD ZZ	SEWING MACHINE, INDUSTRIAL: Zig-Zag; 308 Stitch; Medium Duty; NSN 3530-01-181-1421.
LD ZZ	SEWING MACHINE, INDUSTRIAL: Zig-Zag; 308 Stitch; Light Duty; NSN 3530-01-181-1420.
HD	SEWING MACHINE, INDUSTRIAL: General Sewing; 301 Stitch; Heavy Duty; NSN 3530-01-177-8588.
MD	SEWING MACHINE, INDUSTRIAL: General Sewing; 301 Stitch; Medium Duty; NSN 3530-01-177-8591.
DN	SEWING MACHINE, INDUSTRIAL: Darning; Lock Stitch; NSN 3530-01-177-8589.
LHD	SEWING MACHINE, INDUSTRIAL: 301 Stitch; Light-Heavy Duty; NSN 3530-01-186-3079.
ND	SEWING MACHINE, INDUSTRIAL: 301 Stitch; Double-Needle; NSN 3530-00-892-4636.
BOX X	SEWING MACHINE, AUTOMATIC: Box-X; (Local purchase, Recommend JUKI LK-1900A-HS)
BT	SEWING MACHINE, INDUSTRIAL: Bartack; 42 stitch (Local purchase, Recommended PN HJ1466-1X42)
LD BT	SEWING MACHINE, INDUSTRIAL: Automatic Bartack; 28 stitch; 5/8" x 3/16"; Light Duty

Table 2. Stitching and Re-stitching Specifications.

COMPONENT	RECOMMENDED SEWING MACHINE (CODE SYMBOL)	STITCHES PER INCH	THREAD SIZE
Main Canopy			
Center Section Assembly Reinforcement Panel	LD or ND	7 to 11	E
Cross Seam	LD or ND	7 to 11	E
Main Seam	LD or ND	7 to 11	E
Packing Tabs/Packing Loops	LD/ZZ/BT*	7 to 11	E
Arm Assembly Panels	LD	7 to 11	E
Mesh Panel Assembly	LD/ND/LD ZZ	7 to 11	E
Suspension Line Attaching Loop	Box X/MD/BT*	7 to 11	E
Lower Lateral Band	LD	7 to 11	E

GENERAL PARACHUTE REPAIR – CONTINUED

Table 2. Stitching and Re-stitching Specifications - Continued.

COMPONENT	RECOMMENDED SEWING MACHINE (CODE SYMBOL)	STITCHES PER INCH	THREAD SIZE
Main Canopy – continued.			
Bridle Attachment Assembly	Box X/BT*	7 to 11	E
Main Risers			
Log Record Pocket	MD	7 to 11	E
Main Pack Tray			
Closing Pin Cover	MD	7 to 11	E
Edge Binding	LD	7 to 11	E
Stiffeners	MD	7 to 11	E
Horizontal Backstrap Retainer	MD/LD	7 to 11	E
Diagonal Backstrap Retainer	MD	7 to 11	E
Excess Webbing Keeper Assembly	MD	7 to 11	E
Harness Assembly			
Hip Pad	LD	7 to 11	E
Left Upper Main Lift Web	MD/HD	4 to 6	E
Right Upper Main Lift Web	MD/HD	4 to 6	E
Saddle	MD/HD	4 to 6	3 or 5
Shoulder Pad	BT*/MD	7 to 11	E
Main Deployment Bag			
Suspension Line Stow Loops	MD	7 to 11	E
Locking Stows	MD	7 to 11	FF
Side Flaps	LD/DN	7 to 11	A or E
Tie Down Loops	LD/BT*	7 to 11	E
Main Deployment Sleeve			
Seams	LD/BT*	7 to 11	E
Reserve Canopy			
Suspension Line	BT*	See Table 3	E
Plain Gore Panels	LD	7 to 11	E
Gore Panels 1, 2, and 3	LD	7 to 11	E
Gore Panels 4 and 5	LD	7 to 11	E
Mesh Panel	ND/MD ZZ	7 to 11	E
Scoop	LD	7 to 11	E
Extractor Attachment	LD or ND	7 to 11	E

GENERAL PARACHUTE REPAIR – CONTINUED

Table 2. Stitching and Re-stitching Specifications - Continued.

COMPONENT	RECOMMENDED SEWING MACHINE (CODE SYMBOL)	STITCHES PER INCH	THREAD SIZE
Reserve Canopy – continued.			
Suspension Line Attaching Loop	BT/ZZ	7 to 10	E
Apex Vent Bridle Loop	BT*	See Table 3	E
Reserve Pack Tray			
Edge Binding	LD	7 to 11	E
Elastic Riser Stow Bar	BT/MD	7 to 11	E
Waistband Retainer	BT*	See Table 3	E
Stiffeners	MD	7 to 11	E

* Refer to Table 3 for bartack stitching requirements.

Table 3. Bartack Stitching Requirements.

COMPONENT	DIMENSION	SITICHES PER INCH	THREAD SIZE	PROGRAM
Main Canopy				
Packing Tabs/Packing Loops	1/8 x 3/4	42	E	
Suspension Line Attaching Loop	1/8 x 3/4	42	E	
Bridle Attachment Assembly	1/8 x 1/2	42	E	
Harness Assembly				
Shoulder Pad	1/8 x 7/8	42	E	
Main Deployment Bag				
Tie Down Loops	1/8 x 1/2	42	E	
Main Deployment Sleeve				
Seams	1/8 x 3/4	42	E	
Main Pack Tray				
Bartacks	1/8 x 7/8	42	E	
Reserve Canopy				
Apex Vent Bridle Loop	1/8 x 3/4	42	E	
Skirt Assist Line Attaching Loop	1/8 x 1/2	42	E	
Suspension Line Attaching Loop	1/8 x 1/2	42	E	
Reserve Pack Tray				
Waistband Retainer	1/8 x 7/8	42	E	
Elastic Riser Stow Bar	1/8 x 7/8	42	E	

GENERAL PARACHUTE REPAIR – CONTINUED

Other Parachute Items. Stitching and re-stitching on other parachute items constructed from cloth, canvas, and webbing should be accomplished with thread that matches the color of the original stitching, when possible. All straight stitching should be locked by backstitching at least $\frac{1}{2}$ inch. Re-stitching should be locked by overstitching each end of the stitch formation by $\frac{1}{2}$ inch. Zig-zag stitching does not require locking; however, zig-zag re-stitching should extend at least $\frac{1}{4}$ inch into undamaged stitching at each end, when possible. Re-stitching should be made directly over the original stitching; follow the original stitch pattern as closely as possible.

Darning**CAUTION**

Darning is not authorized on the main and reserve canopies.

Darning is a sewing procedure used to repair limited size holes, rips, and tears. A darning repair may be made either by hand or by sewing machine (Refer to Tables 1 and 2), depending upon the method preferred and the availability of equipment. However, a darning machine should be used to darn small holes and tears where fabric is missing no larger than $\frac{3}{4}$ inch. A darning repair will be performed using the following procedures, as appropriate:

Machine Darning. Proceed as follows (Figure 1):

1. Using an authorized marking aid of contrasting color, mark a square around the damaged area and ensure the marking is at least $\frac{1}{4}$ inch back from each edge of the damaged area.
2. Darn the damaged area by sewing the material in a back and forth manner, using size A or E nylon thread.
3. Turn the material and stitch back and forth across the stitching made in step b until the hole or tear is completely darned.

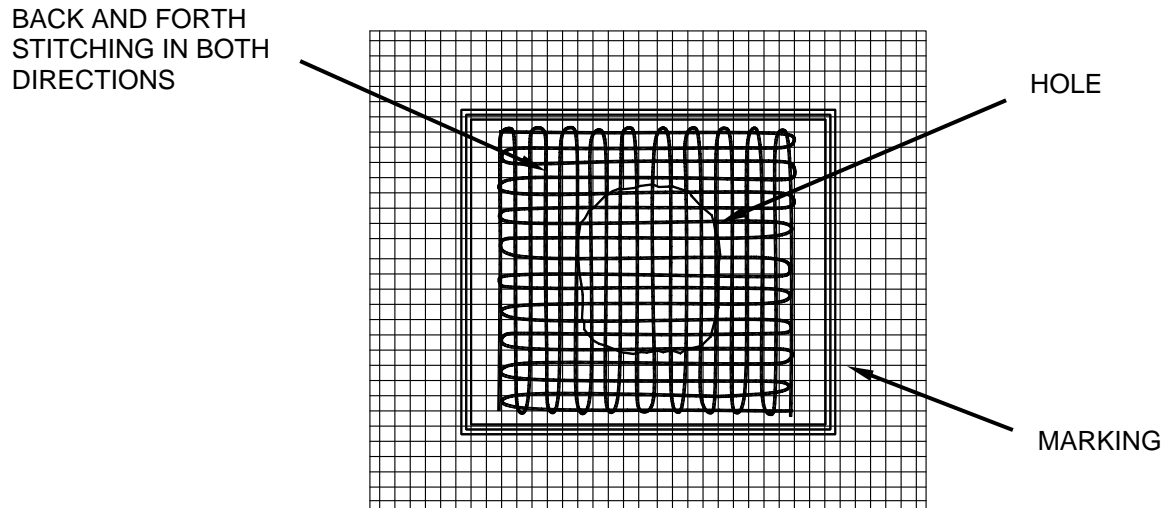

Figure 1. Machine Darning.

4. If applicable, restencil informational data; gore or panel number(s), or identification marks using the criteria in WP 0018.

END OF TASK

GENERAL PARACHUTE REPAIR – CONTINUED

Hand Darning. When repair of a hole or tear is made by hand darning, the darn should match the original weave of the damaged material as closely as possible. Hand darning will be performed as follows (Figure 2):

1. Using an authorized marking aid of contrasting color, mark a square around the damaged area and ensure the marking is at least ¼ inch back from each edge of the damaged area.
2. Using a darning needle and a length of size A or E nylon thread, begin darning at one corner of the marked area. Working parallel with the marking, pass the needle and thread back and forth through the material until the opposite diagonal corner of the marked area is reached.
3. Turn the material and weave the needle and thread back and forth across the stitching made in step b until the hole is completely darned.
4. If applicable, restencil informational data or identification marks as outlined in WP 0019.

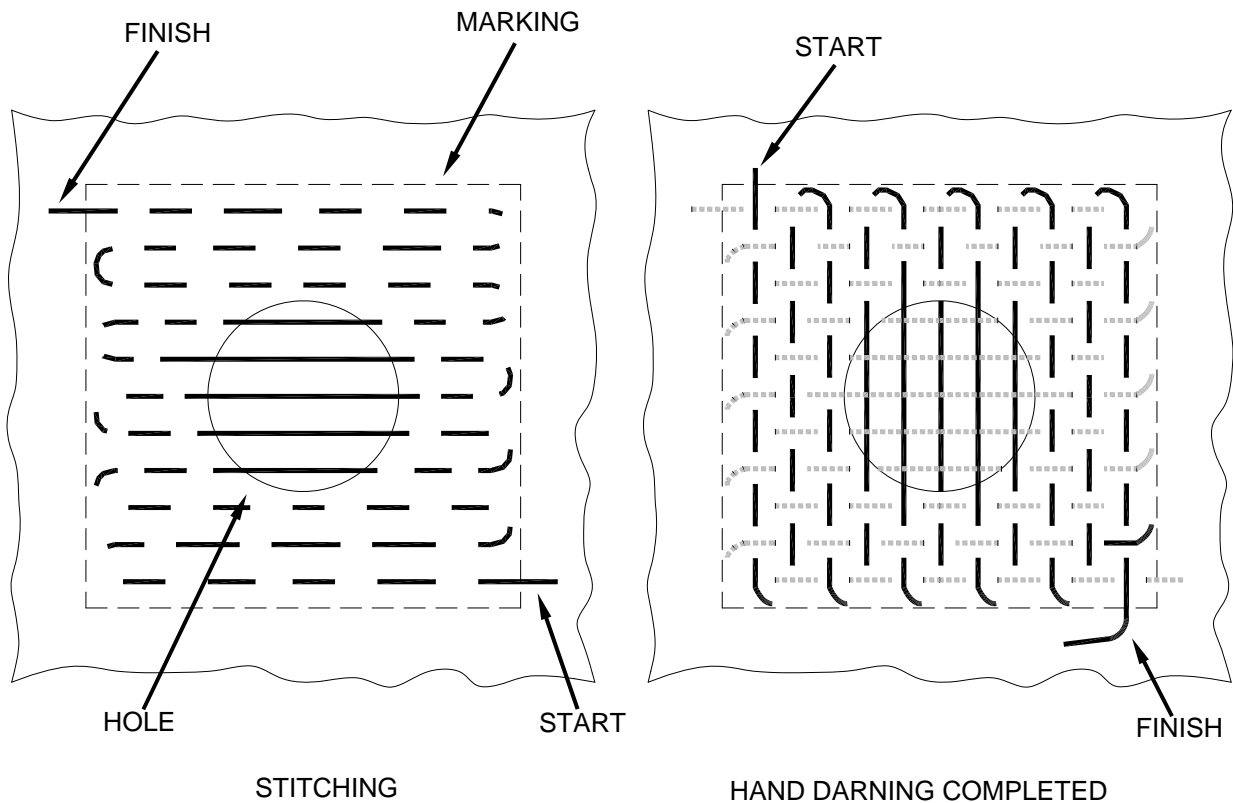

Figure 2. Hand Darning.

GENERAL PARACHUTE REPAIR – CONTINUED

BOX X Stitching Pattern

NOTE

Use the maintenance instructions related to the repair or replacement being conducted for required thread and stitching requirements.

Number 1 in the drawing is the top of the Box X stitch pattern.

Use the following diagram (Figure 3) to complete the Box X stitch pattern. Start the Box X at the 1 position and follow the numbers in sequence finishing with a 1/2 inch locking stitch.

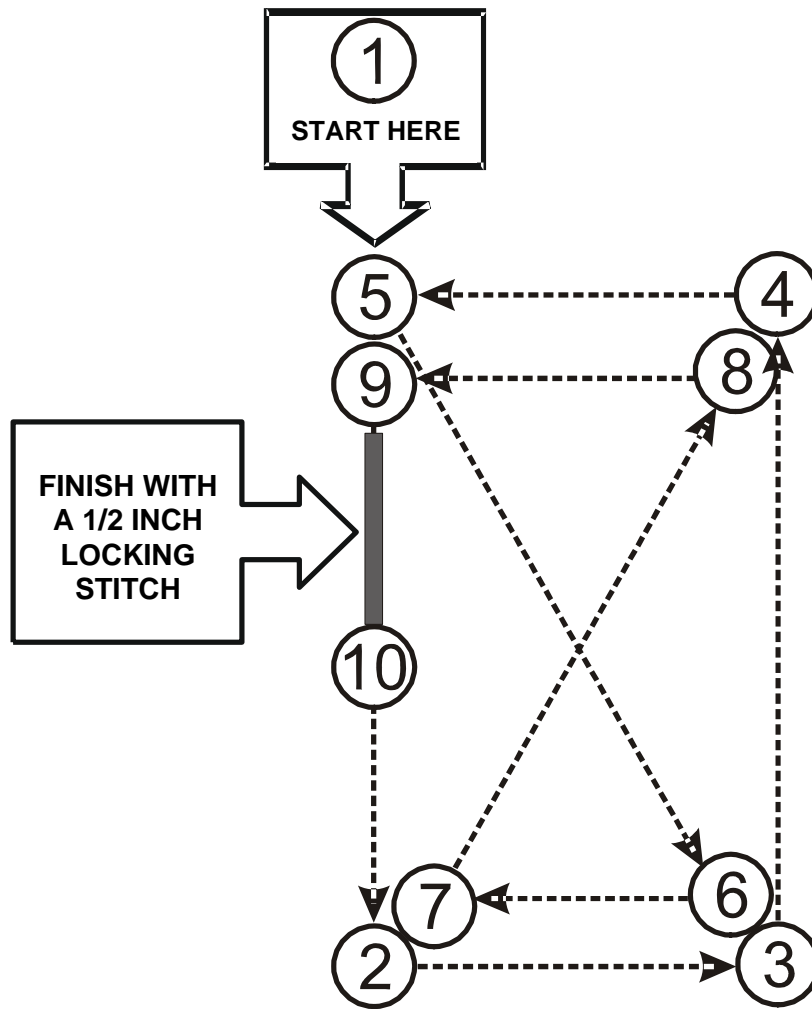

Figure 3. Box Stitching Pattern with Locking Stitch.

GENERAL PARACHUTE REPAIR – CONTINUED

Zig-Zag Sewing

Components of the T-11 Personnel Parachute System, except the parachute canopy, that have sustained cut or tear damage, may be repaired by zig-zag sewing (Refer to Tables 1 and 2), provided the applicable damaged area does not have any material missing and the cut or tear is straight or L-shaped. Should the damaged area be irregular shaped or have material missing, the repair will be achieved by either darning or patching, as required. A zig-zag sewing repair will be accomplished using a zig-zag sewing machine, with the following procedures:

1. Set the sewing machine to the maximum stitch width.
2. Beginning at a point ¼ inch beyond one end of the cut or tear, stitch lengthwise along the damaged area to a point ¼ inch beyond the opposite end of the cut or tear (Figure 4).

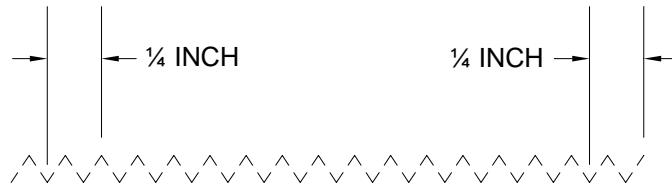

Figure 4. Straight Cut or Tear Stitching.

3. The cited stitching procedure will also apply to an L-shaped cut or tear (Figure 5).

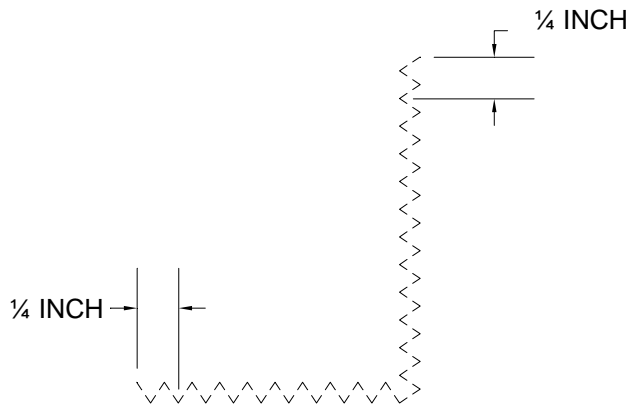

Figure 5. L-Shaped Cut or Tear Stitching.

4. If applicable, re-stencil informational data or identification marks as prescribed in WP 0019.

END OF TASK

Patching

Patching is a procedure used to repair holes that cannot be darned.

GENERAL PARACHUTE REPAIR – CONTINUED

Parachute Canopy Patching Limitations. The following is a list of patching limitations for the T-11 Personnel Parachute System (Figure 6):

WARNING



The limitations prescribed for the parachute canopy patching will be stringently adhered to under all circumstances and without any deviations. Failure to do so may result in death or serious injury to personnel.

1. A patch will not be applied to a damaged area that has been previously patched.
2. Each canopy panel has specified repair limitations. Determination should be made as to the most economical method to be used, i.e., the number of allowable patches versus a panel replacement. A patch applied to a parachute canopy may extend from main seam to main seam. The damaged area of any main canopy panel may not exceed 50% of the total surface area. The number of allowable patches may not exceed 50% of the total surface area.
3. Parachute mending cloth is not authorized on the T-11 Personnel Parachute System.

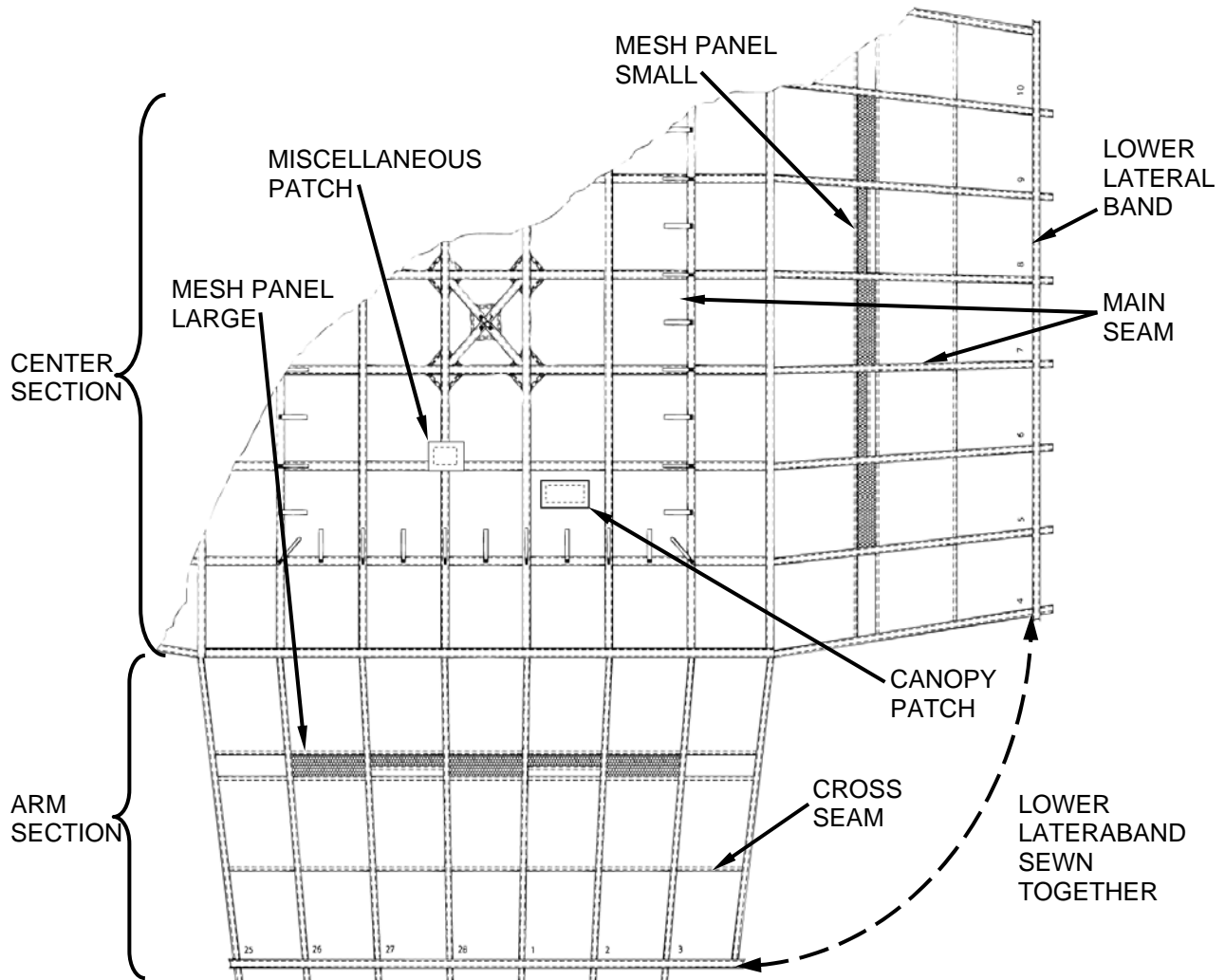

Figure 6. Canopy Layout and Patch Construction.

GENERAL PARACHUTE REPAIR – CONTINUED

Making a Basic Patch. A basic patch is used to repair damaged cloth when the affected area is no closer than 1 inch from a main seam, cross seam or lower lateral band. Should a damaged area be closer than 1 inch to the cited areas, a miscellaneous patch will be made. There are three methods that may be used to apply a basic patch; the procedures for performing each method are outlined below.

NOTE

A basic patch applied to the parachute canopy by sewing will be square or rectangular in shape.

Sewn Patch. The primary method of applying a basic patch is by sewing (Figure 7). When using this method of patching on a parachute canopy, the patch will be applied to the inside of the canopy. The deployment bag may be patched on either the inside or the outside.

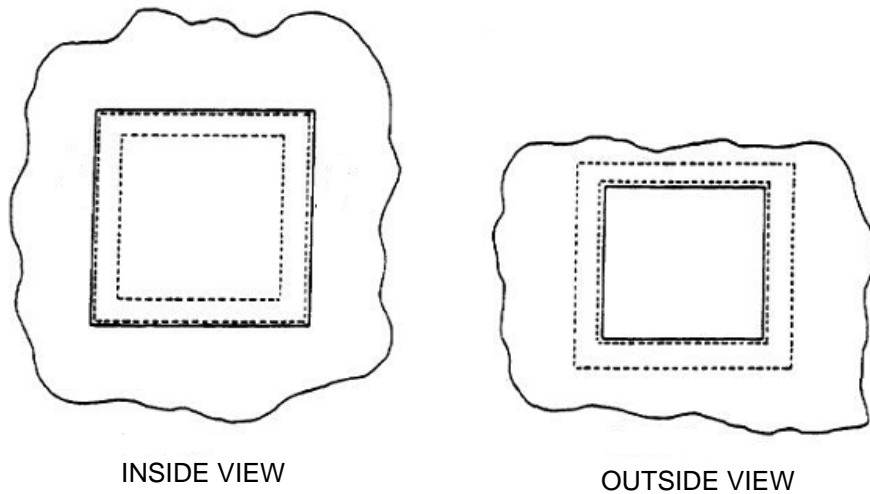

Figure 7. Sewn Patch.

GENERAL PARACHUTE REPAIR – CONTINUED

Apply a sewn patch as follows:

1. Invert the damaged panel. Smooth out the damaged panel on a repair table and secure the surrounding area with T-pins (Figure 8).



Figure 8. Inverting Damaged Panel and Securing with T-pins.

2. Measure the damaged area. Cut new material of same type 6 inches longer and wider than the damaged area (Figure 9).



Figure 9. Measuring Damaged Area and Cutting Section of New Material.

GENERAL PARACHUTE REPAIR – CONTINUED

3. Place the new material centered over the damaged area folding the ends under ½ inch and secure with T-pins (Figure 10).



Figure 10. Placing New Material over Damaged Area and Securing with T-pins.

4. Secure the new material to the damaged area with T-pins or by basting.
5. Remove the T-pins securing the canopy to the table.
6. Sew the new material over the damaged area 1/16-inch in from the edge (Figure 11).



Figure 11. Sewing New Material over Damaged Area 1/16-inch from Edge.

GENERAL PARACHUTE REPAIR – CONTINUED

7. Re-invert the damaged area of the canopy. Place it onto the sewing table with the patch side down (Figure 12).



Figure 12. Re-inverting Damaged Area and Placing onto Sewing Table Patch Side Down.

8. Mark 1-inch in from the stitches (Figure 13). Remove the damaged area by cutting along the marked line.



Figure 13. Marking 1-inch in from Stitches and Removing Damaged Area.

GENERAL PARACHUTE REPAIR – CONTINUED

9. Measure in ½-inch from the inside corner toward outside corner at a 45 degree angle (Figure 14). Cut along marked line.



Figure 14. Cutting Patch Corners.

10. Fold the inside edge under ½-inch, incorporating the patch material (Figure 14). Sew 1/16-inch in along the folded in edge.



Figure 15. Sewn Patch.

END OF TASK

GENERAL PARACHUTE REPAIR – CONTINUED

Applying a Miscellaneous Canopy Patch. A miscellaneous canopy patch, which may be irregularly shaped, is used to repair damaged canopy material when the location of the damaged area requires the patch to extend into a seam, joint, reinforcement, or lateral band. Determine the type of patch required for the canopy, using the details in illustrations following the canopy patch procedures detailed below. Apply a miscellaneous patch to a panel as follows (Figure 16):

NOTE

Use applicable details in STITCHING AND RE-STITCHING.

1. Identify the damaged area. If desired, outline the damaged area with a marking pen, tailor's chalk, etc.
2. Determine which seams, joints, reinforcements, or lateral bands will be involved in the patch.
3. Determine the patch size and shape.
4. As required, cut the applicable stitching to remove or lay aside items that may interfere with the patching process. Open any seam, joint, reinforcement, or lateral band seam involved in the patch, by removing the stitching.
5. Using the same type of material as in the original construction, mark and cut a patch that is the same shape as the damaged area and approximately 1½ inches larger in all directions except in the direction of the open seam(s), unless otherwise specified. Cut the open seam edge(s) of the patch to match the open seam edge of the canopy.
6. Working from the inside of the parachute, align the patch with the fabric weave and over the damaged area.
7. Start adjacent to an open seam edge of the canopy, folding that patch edge under ½ inch.
8. Start sewing 1/16-inch in along the patch edge.
9. Continue sewing to just short of 1½ inches from the next side. Fold the next side under ½ inch and sew to the corner. Repeat until all four sides have been sewn down. Be sure to overlap the stitching start by at least 2 inches.
10. Working from the outside of the parachute using scissors, cut the damaged area out forming a rectangle that is approximately 1 inch from the initial patch stitch line. Be careful not to cut the patch. The open seam edges of both the patch and the canopy should be flush with one another.
11. Cut the corners of the canopy cloth from the inside towards the patch corner stopping approximately ½ inch from the sides allowing for a ½-inch fold under of the canopy cloth to the patch stitch line. There is no fold under on open seams.
12. Start adjacent to an open seam and fold that edge under (approximately ½ inch) forming a straight seam from the open seam to an inside corner. Note that the width of the patch seam should be consistent but can be as narrow as 3/8 inch and as wide as 1 inch.
13. Sew the first side from the open seam to the first inside corner, keeping the stitching 1/16 inch from the edge. Fold the next side under while maintaining the patch seam width. Repeat until all except the open seams have been sewn down. The open seam ends of the patch do not require backstitching.

GENERAL PARACHUTE REPAIR – CONTINUED

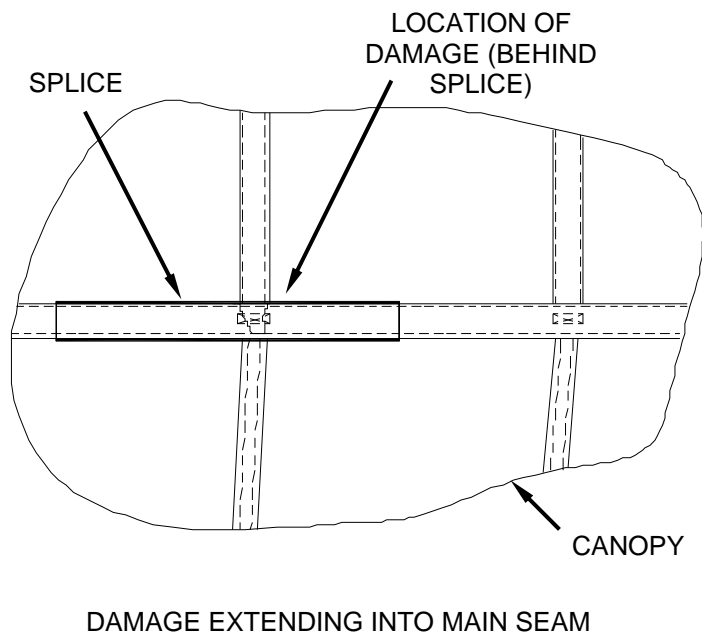
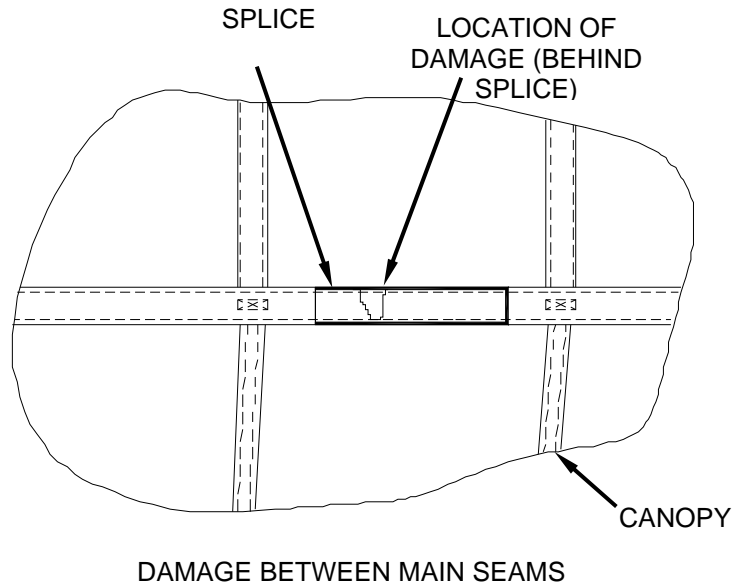

Figure 16. Canopy Repair.

NOTE

The cloth portion of the patch is finished. The damaged area has been removed leaving reassembly to complete the repair.

14. Re-assemble the panel seam.
15. Close any seam, joint, reinforcement, or lateral band seam involved in the patch, by replacing the stitching. Re-attach or replace any parts or stitching that was removed or laid aside prior to the patching process.
16. If applicable, re-stencil informational data or gore numbers according to procedures in WP 0018.

GENERAL PARACHUTE REPAIR – CONTINUED

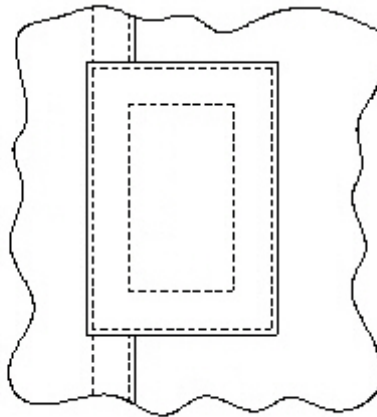

INSIDE VIEW

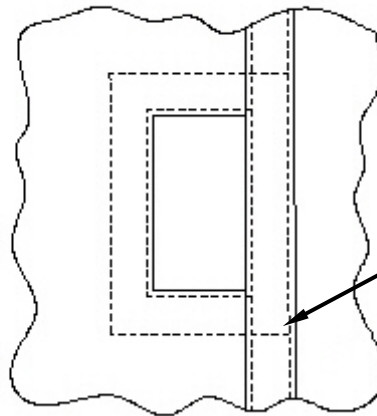

OUTSIDE VIEW

Figure 17. Rectangular Patch Including Main Seam.

GENERAL PARACHUTE REPAIR – CONTINUED

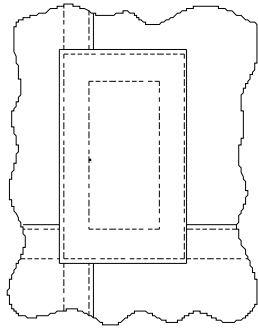

INSIDE VIEW

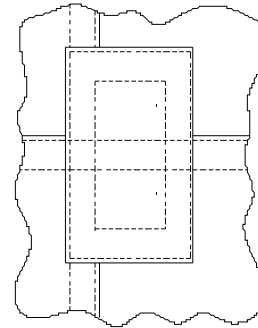

INSIDE VIEW

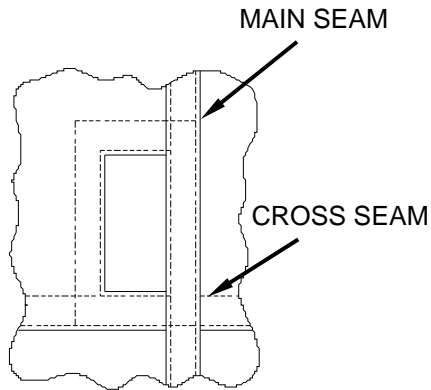

OUTSIDE VIEW

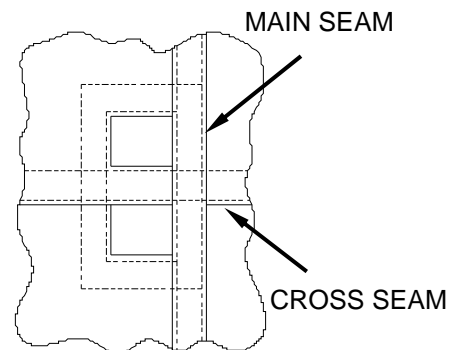

OUTSIDE VIEW

Figure 18. Rectangular Patch Including a Main Seam and a Cross Seam.

Figure 19. Rectangular Patch Crossing a Cross Seam and Including Main Seam.

GENERAL PARACHUTE REPAIR – CONTINUED

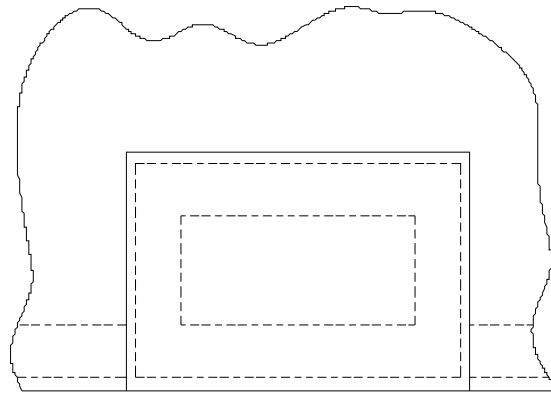

INSIDE VIEW

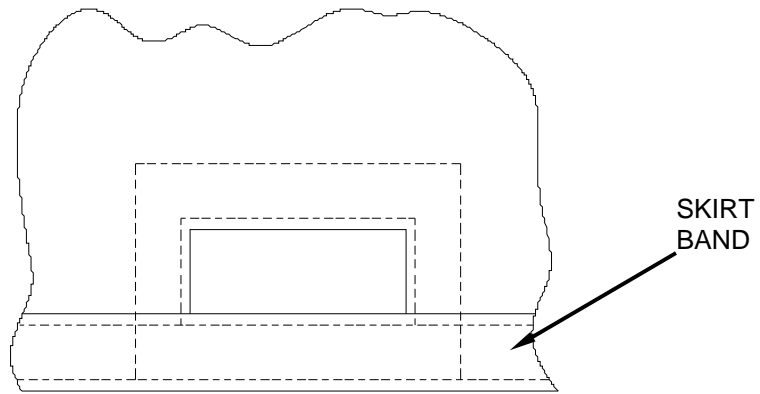

OUTSIDE VIEW

Figure 20. Rectangular Patch Including Lower Lateral Band.

GENERAL PARACHUTE REPAIR – CONTINUED

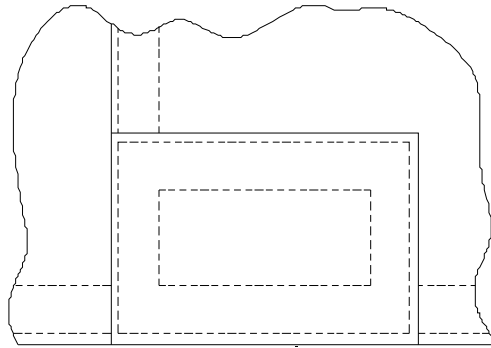

INSIDE VIEW

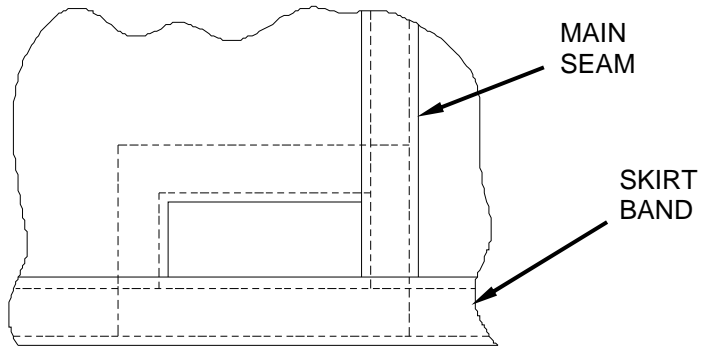

OUTSIDE VIEW

Figure 21. Rectangular Patch Including Main Seam and Lower Lateral Band.

END OF TASK

GENERAL PARACHUTE REPAIR – CONTINUED**Tying a Girth Hitch Knot**

When threading a new line use the following procedures when forming the girth hitch knot (Figure 22):

1. Thread the new line through the loop, from bottom to top.
2. Route back over the top of the loop.
3. Cross back under the new line.
4. Then back through the loop from top to bottom.
5. Then route between the loop and new line which forms a loop then pull tight.

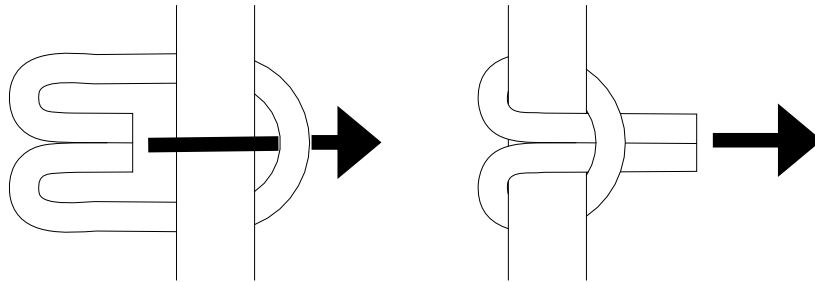

Figure 22. Girth Hitch.

END OF TASK**Tying a Surgeon's Knot Locking Knot**

1. Take two lines and wrap one around the other twice.
2. Form an overhand knot above the wraps using the two working ends of the lines.
3. Flatten the knot by applying pressure on the two standing parts.
4. Form another overhand knot above the wraps using the two working ends of the lines.
5. Tighten the knot with even pressure on the working ends and standing parts (Figure 23).

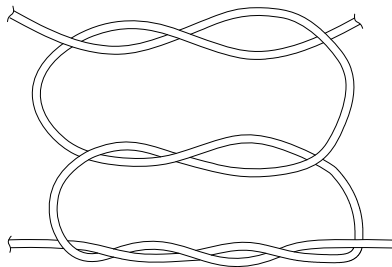

Figure 23. Surgeon's Knot Locking Knot.

END OF TASK

GENERAL PARACHUTE REPAIR – CONTINUED**Tying an Overhand Knot**

1. Hold rope out parallel to the ground and cross it over to form a loop.
2. Wrap the right-hand end through the loop. Pull to tighten (Figure 24).

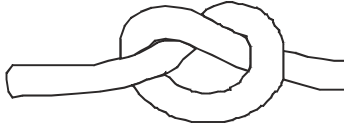

Figure 24. Overhand Knot.

END OF TASK**Tying a Square Knot**

1. Make an "X" with the rope ends, with the right end on top, and tie an overhand knot, twisting the right end around the left end (Figure 25).

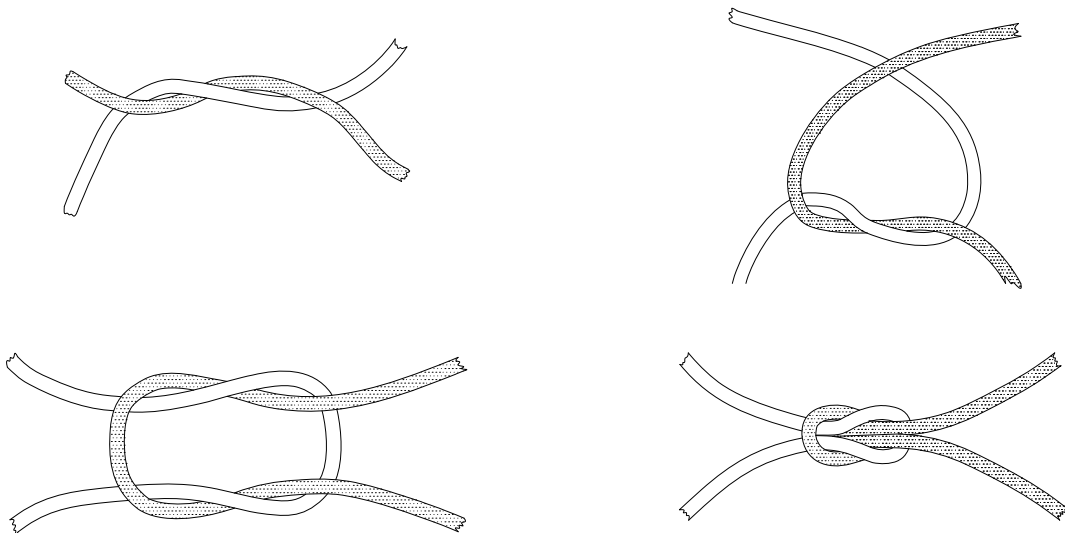

Figure 25. Square Knot.

2. With the "new" right and left, put the left over the right, and tie another overhand knot.

NOTE

The knot should look very neat - like a square - essentially looking like a loop stuck in another loop.

3. Pull tightly.

END OF TASK**Maintenance Forms**

Figures 26 and 27 may be locally reproduced for use in maintenance forms.

GENERAL PARACHUTE REPAIR – CONTINUED

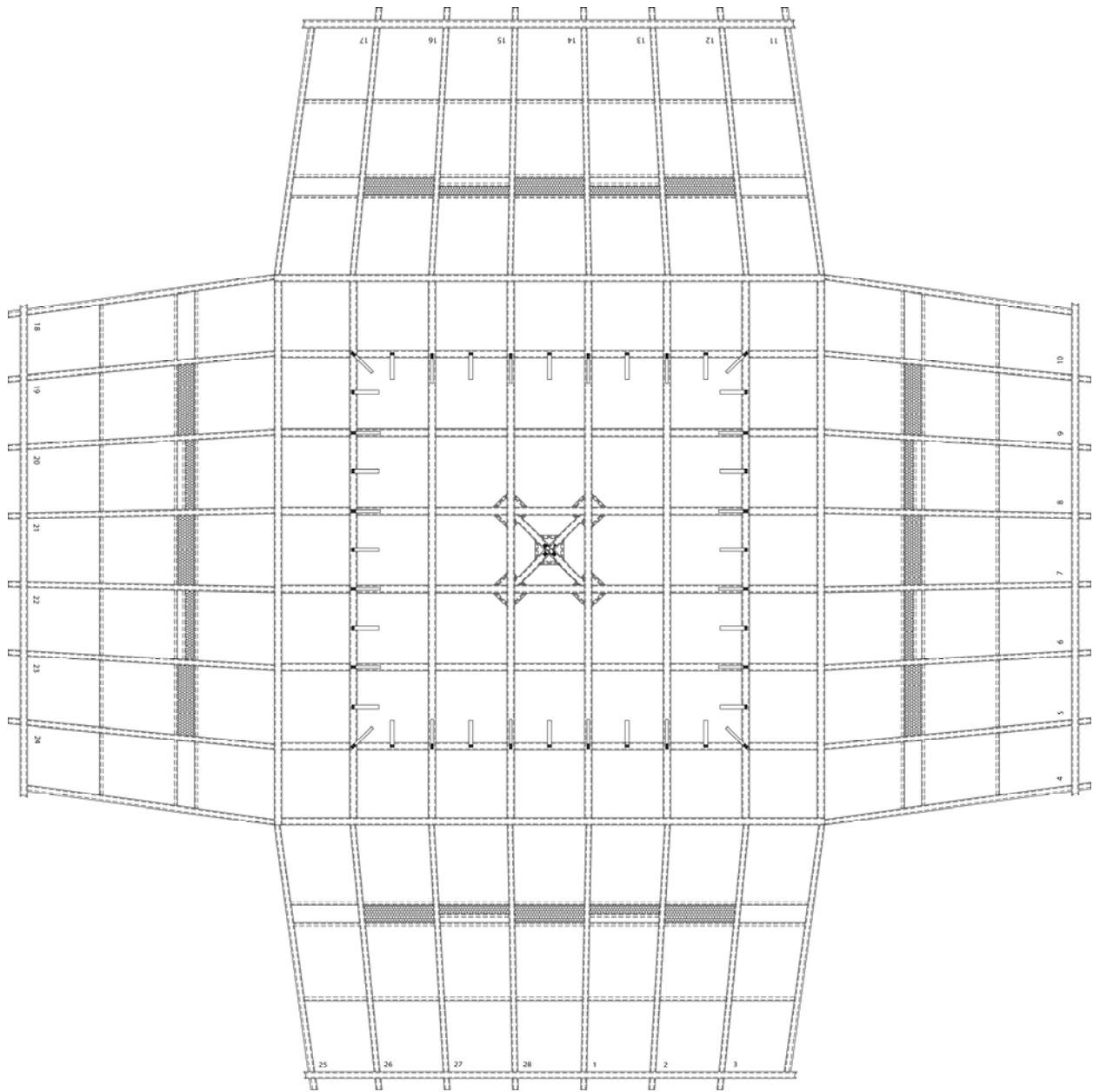

Figure 26. T-11 Main Canopy.

GENERAL PARACHUTE REPAIR – CONTINUED

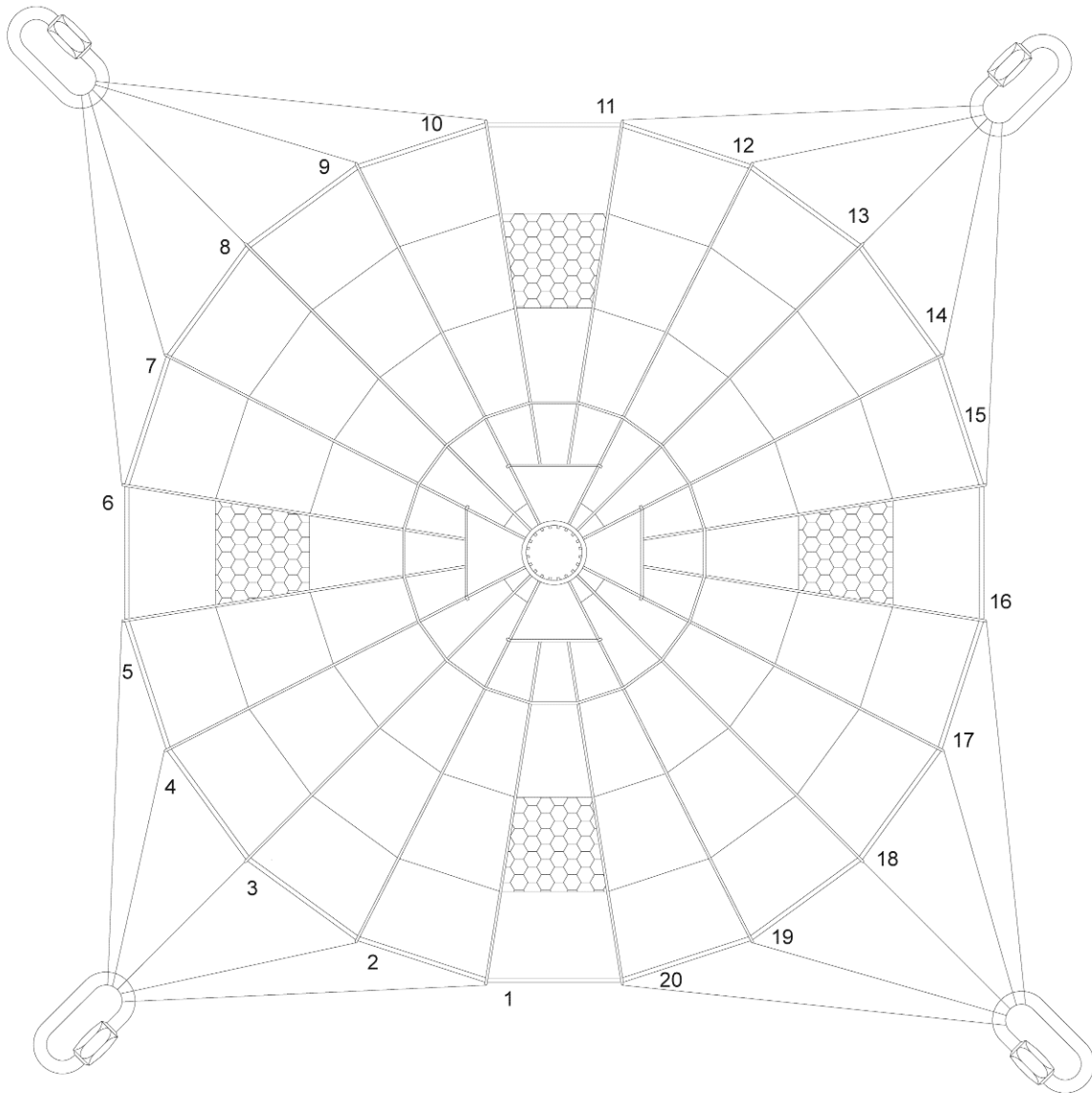

Figure 27. T-11 Reserve Canopy.

END OF WORK PACKAGE

FIELD MAINTENANCE**SEARING AND WAXING
REPAIR****INITIAL SETUP:****Tools and Special Tools**

Electric Pot, Melting (WP 0102, Item 15)
Heated Blade Cutter (WP 0102, Item 18)

Personnel Required

Parachute Rigger 92R1P (1)

Materials/Parts

Beeswax (WP 0101, Item 4)
Wax, Paraffin (WP 0101, Item 55)

References

None required

Equipment Condition

Unpacked.

REPAIR**CAUTION**

Cotton tape, webbing, or cord are not to be seared.

NOTE

Fabric materials such as cord, tape, and webbing, that are cut for use in the maintenance of the T-11 Personnel Parachute System, will normally be heat-seared or dipped in a melted wax mixture, as applicable, to prevent the material from fraying or unraveling. However, in some instances, the preparation of the material may not be necessary and will be specified accordingly.

Searing

The cut ends of nylon tape, webbing, and cord lengths may be prepared by heat-searing, which is performed by pressing the raw end of the material against a hot metal surface (heated blade cutter) until the nylon has melted sufficiently. Avoid forming a sharp edge or lumped effect on the melted end.

END OF TASK**Waxing**

The fraying or unraveling of cotton or nylon tape, webbing, and cord length ends may be prevented by dipping ½ inch of the raw end of the material into a thoroughly melted mixture of half beeswax and half paraffin in an electric melting pot. The wax temperature should be substantial enough to ensure the wax completely penetrates the material, rather than just coating the exterior fabric.

END OF TASK**END OF WORK PACKAGE**

FIELD MAINTENANCE
MARKING AND RESTENCILING
REPAIR

INITIAL SETUP:**Tools and Special Tools**

Brush, Stenciling (WP 0102, Item 7)
Machine, Stencil Cutting (Hand Operated)
(WP 0102, Item 28)

Personnel Required

Parachute Rigger 92R1P (1)

Materials/Parts

Ink, Parachute Marking, Light Blue, A-A-59291
(WP 0101, Item 26)
Marker, Felt Tip, Black, Permanent (WP 0106,
Item 28)
Pen, Ball Point (WP 0106, Item 29)
Stencil Board, Oiled (WP 0106, Item 37)

References

None required

Equipment Condition

Lay out on packing table or other suitable area

REPAIR**NOTE**

Stenciling should be used whenever possible. A ball point pen or permanent felt tip marker should be used only where stenciling is not possible, or when stenciling devices are not available. Only labels may be marked with any type ball point pen using black or blue ink.

Original stenciled data or marking that becomes faded, illegible, obliterated, or removed as a result of performing a repair procedure, will be remarked with a ball point pen, permanent felt tip marker, or re-stenciled. All marking or re-stenciling will be done on, or as near as possible to, the original location and should conform to the original lettering type and size.

If the date placed in service is illegible, use the original manufactured date as the date placed in service.

Marking

Using marking devices, such as a ball point pen or permanent felt tip marker, mark on, or as near as possible to, the original location and conform to the original lettering type and size, on labels only. Do not use ballpoint pens or felt tip markers on the canopy material.

END OF TASK**Re-stenciling**

Proceed as follows:

1. Cut oiled stencil board to match the original lettering type and size of data to be re-stenciled.
2. Place cut stencil board over, or as near as possible to, the original marking to be re-stenciled.

REPAIR - CONTINUED

3. Place an additional sheet of stencil board beneath the area to be re-stenciled to prevent the marking ink from penetrating to other areas.
4. Hold the stencil board in place and, using the stenciling brush filled with parachute marking ink, re-stencil the original marking.

END OF TASK**Remarking and Re-stenciling**

Remark/re-stencil the original stenciled data/markings that become faded, illegible, obliterated, or that have been removed as a result of performing a repair procedure. Ensure all marking/re-stenciling is on, or as near as possible to, the original location, and conforms to the original lettering type and size. Do not use ballpoint pens or felt tip markers on the canopy material.

END OF TASK**END OF WORK PACKAGE**

FIELD MAINTENANCE

T-11 MAIN PARACHUTE ASSEMBLY
REPAIR

INITIAL SETUP:

Tools and Special Tools

None required

Personnel Required

Parachute Rigger 92R1P (1)

Materials/Parts

None required

References

WP 0015
WP 0027
WP 0028
WP 0029
WP 0030
WP 0033
WP 0034

Equipment Condition

Unpacked

REPAIR

Refer to Table 1 for information on repair procedures for the T-11 Main Canopy.

Table 1. T-11 Main Canopy Repair References.

COMPONENT	WORK PACKAGE
General Repairs	WP 0015
Arm Assemblies	WP 0027
Center Section Assembly	WP 0028
Center Section Reinforcement Panels	WP 0029
Main Mesh Panel	WP 0030
Main Seams	WP 0033
Lower Lateral Band	WP 0034

END OF WORK PACKAGE

FIELD MAINTENANCE

MAIN CANOPY SUSPENSION LINE ASSEMBLY REPLACE

INITIAL SETUP:**Tools and Special Tools**

Crowfoot Attachment, Socket Wrench, 3/8 inch Drive, Open End, 7/16 inch (WP 0102, Item 12)
 Knife, Pocket (WP 0102, Item 25)
 Wrench, Adjustable, 8 inch (WP 0102, Item 73)
 Wrench, Torque, 0-300 inch Pounds (WP 0102, Item 74)

Personnel Required

Parachute Rigger 92R1P (1)

References

WP 0007

Materials/Parts

None required

Equipment Condition

Unpacked

REPLACE

1. Place the canopy in proper layout IAW WP 0007.
2. Identify the damaged suspension line at the lower lateral band.

NOTE

When choosing a line adjacent to the damaged suspension line, ensure that both lines run to the same connector link. If possible, both suspension lines should also run through the same arm of the slider.

3. Orient the canopy so that the damaged suspension line (Figure 1, Item 1) and one adjacent line (Figure 1, Item 2) are on top and run free and clear from the lower lateral band to the connector link (Figure 1, Item 3).



Figure 1. Replacing a Main Canopy Suspension Line.

REPLACE – CONTINUED

WARNING

When cutting the damaged suspension line, be careful not to damage the suspension line attachment loop. Repair any damaged suspension line attachment loop. Failure to do so could result in serious injury or death to the parachutist.

4. Cut and remove damaged suspension line from the suspension line attaching loop.
5. Obtain a new suspension line from stock.
6. Girth hitch the new suspension line to the suspension line attachment loop (Figure 2, Item 1).
7. Using the adjacent suspension line as a guide, trace the new suspension line toward the slider, removing all turns, tangles, twists or knots.

WARNING

Proper layout of the slider and proper routing of the suspension line through the slider grommet is critical to proper performance. Failure to remove twists from the slider arms and failure to properly route could result in serious injury or death to the parachutist.

8. Route the suspension line (Figure 2, Item 2) through the appropriate slider grommet (Figure 2, Item 3) from top to bottom, ensuring the slider arms are free of twists.

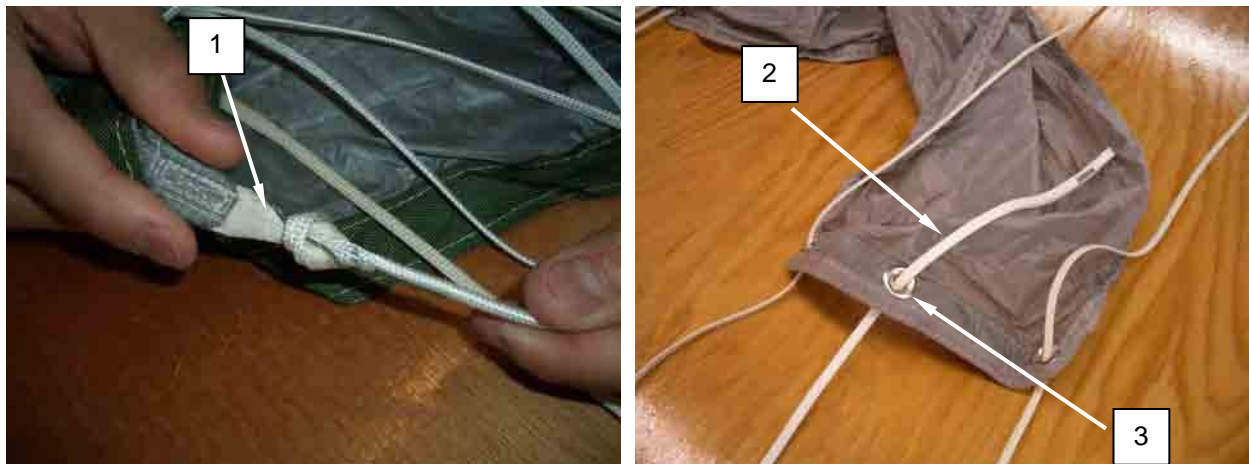

Figure 2. Routing Suspension Line through Slider.

REPLACE – CONTINUED

9. Continue to trace the new suspension line to the connector link (Figure 3, Item 1).

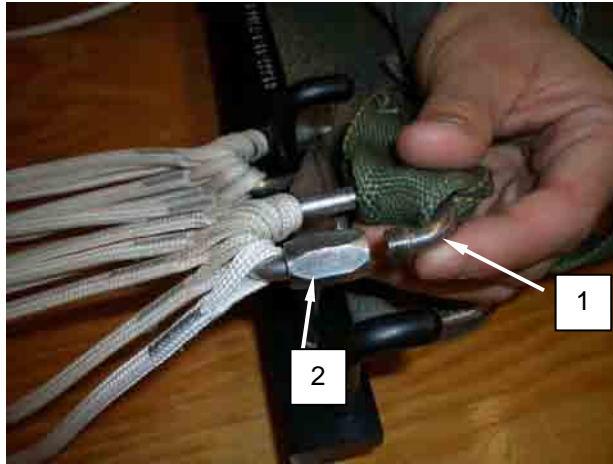

Figure 3. Replacing a Main Canopy Suspension Line.

10. Place new suspension line on an appropriate tool to prevent twists and to maintain positive control.

NOTE

If the damaged suspension line is located on a bottom connector link, moving the top connector link to the opposite side of the pack table will aid in proper line continuity.

11. Using an 8-inch adjustable wrench, loosen barrel nut (Figure 3, Item 2) on the connector link with the damaged suspension line.
12. Using a stitch removal tool, cut and remove the lacing and tying tape on the riser that secures the connector link.

NOTE

All suspension lines will be removed from the connector link, including the damaged line.

13. Remove the suspension lines from the connector link one at a time and place on an appropriate tool.
14. Remove connector link from riser and discard.
15. Obtain new connector link from stock.
16. Position new connector link on the riser so the barrel faces inboard and tightens downward.
17. Install suspension lines onto new connector link sequentially from the tool until the damaged line is reached.
18. Remove damaged line from tool and discard.
19. Place new suspension line on connector link.
20. Continue installing the remaining suspension lines onto the connector link sequentially until they are all transferred.

REPLACE – CONTINUED

21. Finger tighten barrel nut.

22. Perform a line continuity check, tack riser and tighten barrel nut IAW sections of WP 0007 entitled “Perform 100% Line Continuity Check” and “Torque and Tack Main Risers.”

END OF TASK

END OF WORK PACKAGE

FIELD MAINTENANCE

**MAIN CANOPY SUSPENSION LINE PARACHUTE CONNECTOR LINK
REPLACE**

INITIAL SETUP:**Tools and Special Tools**

Crowfoot Attachment, Socket Wrench, 3/8 inch Drive, Open End, 7/16 inch (WP 0102, Item 12)
 Knife, Pocket (WP 0102, Item 25)
 Needle, Upholsterer's, Curved, Size 3 (WP 0102, Item 31)
 Stitch Removal Tool (WP 0102, Item 64)
 Wrench, Adjustable, 8 inch (WP 0102, Item 73)
 Wrench, Torque, 0-300 inch Pounds (WP 0107, Item 74)

Personnel Required

Parachute Rigger 92R1P (1)

References

WP 0007

Materials/Parts

Tape, Lacing and Tying, Nylon, A-A-52080-B-3 (WP 0101, Item 41)

Equipment Condition

Unpacked.

REPLACE**NOTE**

Whenever a connector link is opened it must be replaced.

A parachute suspension line connector link that is damaged will be replaced with a new suspension line connector link assembly from stock. Use the following procedures:

1. Place the canopy in proper layout IAW WP 0007 on the repair table or repair surface.

REPLACE - CONTINUED**CAUTION**

When cutting the lacing and tying tape, ensure surrounding webbing is not damaged.

2. Using a stitch removal tool, cut and remove the lacing and tying tape (Figure 1, Item 1) that secures the connector link (Figure 1, Item 2).
3. Using an 8-inch adjustable wrench, loosen barrel nut (Figure 1, Item 3) on defective connector link.
4. Remove all suspension lines (Figure 1, Item 4) sequentially and place on an appropriate tool.
5. Remove defective connector link from riser and discard.
6. Obtain a new connector link.
7. Position new connector link on the riser so that barrels face inboard and tighten downward.

NOTE

When installing suspension lines onto connector link, ensure there are no twists in the lines.

8. Install suspension lines (Figure 1, Item 4) onto new connector link sequentially from tool (Figure 1, Item 2).
9. Finger tighten barrel nut (Figure 1, Item 3).

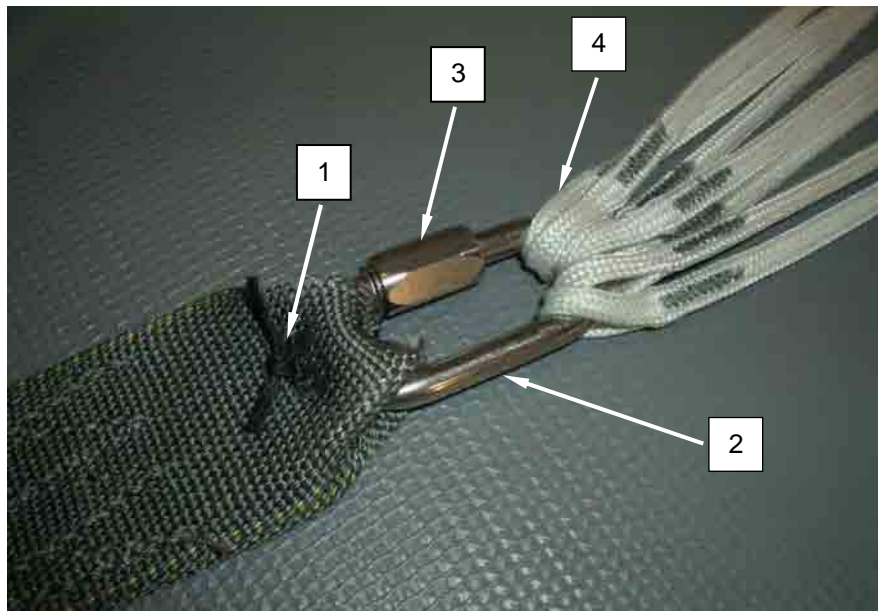

Figure 1. Replacing Main Canopy Suspension Line Connector Link.

10. Perform a line continuity check and tack riser and tighten barrel nut IAW sections of WP 0007 entitled "Perform 100% Line Continuity Check" and "Torque and Tack Main Risers."

END OF TASK

END OF WORK PACKAGE

FIELD MAINTENANCE

T-11 MAIN BRIDLE ASSEMBLY
REPLACE

INITIAL SETUP:

Tools and Special Tools

Sleeve Organizer, Deployment, T-11 Main
(WP 0102, Item 62)
Wrench, Adjustable, 8 inch (WP 0102, Item
73)

Materials/Parts

N/A

Personnel Required

Parachute Rigger 92R1P (1)

References

WP 0007

Equipment Condition

Parachute in proper layout.

REPLACE

1. At the upper end of the pack table, detach the bridle line ring from the quick release hook and move below the deployment sleeve organizer.
2. Swing the deployment sleeve organizer into position on pack table.
3. Open the hook and pile tape (Figure 1, Item 1) on the upper end of the deployment sleeve and feed the deployment sleeve onto the deployment sleeve organizer (Figure 1, Item 2). Ensure that the bridle line attachment loop (Figure 1, Item 3) is exposed and facing up.



Figure 1. Place Sleeve onto Sleeve Organizer.

4. Remove connector link and discard.
5. Remove defective bridle line from bridle line attachment loop and discard.
6. Obtain serviceable items from stock.

REPLACE-CONTINUED

7. To attach new bridle line refer to section of WP 0007 entitled "Attach the Main Parachute Bridle Line".

END OF TASK

END OF WORK PACKAGE

FIELD MAINTENANCE

BRIDLE LINE PARACHUTE CONNECTOR LINK
REPLACE

INITIAL SETUP:

Tools and Special Tools

None required

Personnel Required

Parachute Rigger 92R1P (1)

Materials/Parts

None required

Equipment Condition

Parachute in proper layout.

REPLACE

1. Loosen barrel nut (Figure 1, Item 1) on bridle line connector link (Figure 1, Item 2).
2. Remove bridle line connector link (Figure 1, Item 2).

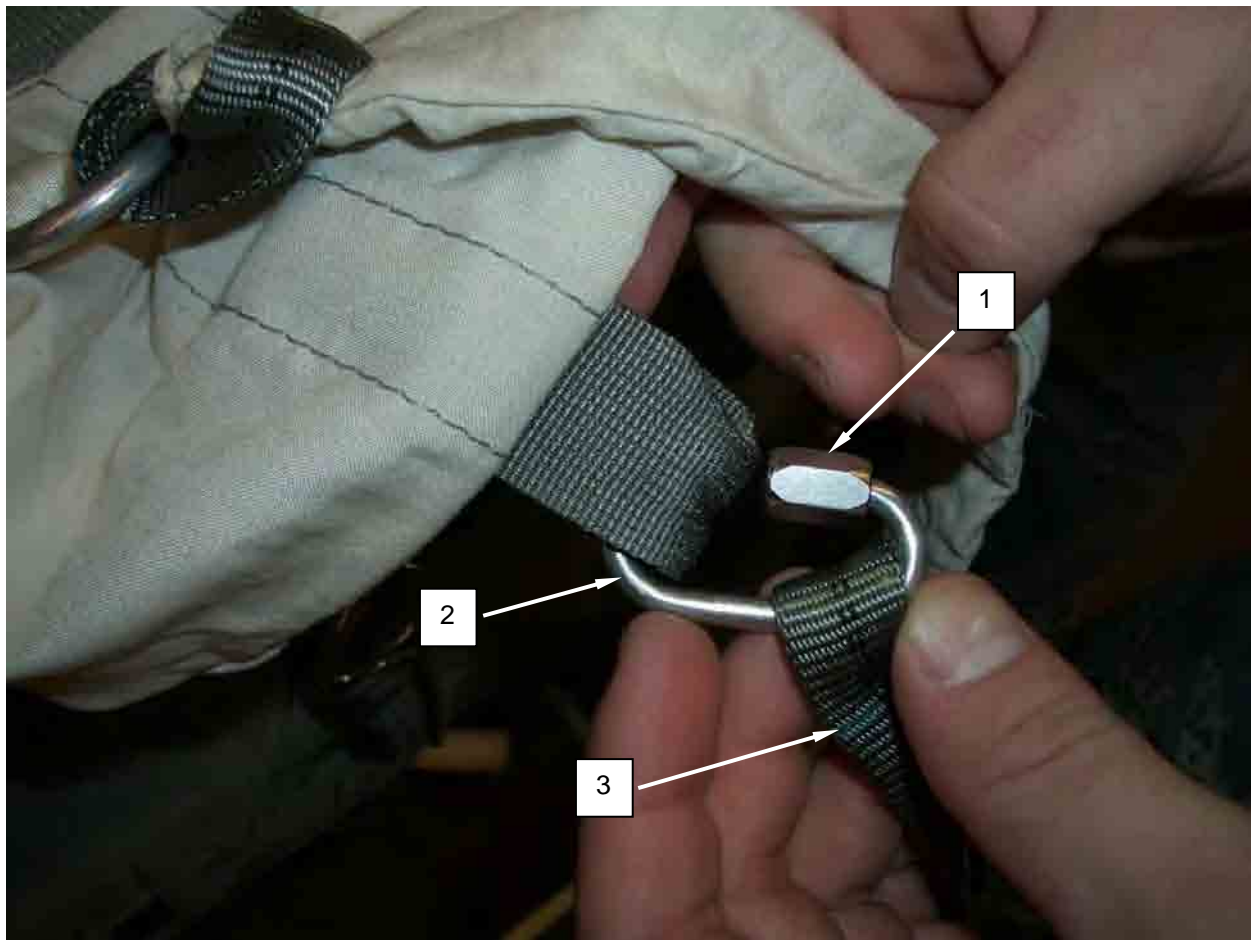

Figure 1. Replacing Connector Links.

REPLACE - CONTINUED

3. Discard unserviceable link.
4. Obtain serviceable item from stock.
5. Attach the new connector link (Figure 2, Item 1) to the end of the main parachute bridle line (Figure 2, Item 2) to the connector link attaching loop (Figure 2, Item 3).
6. Ensure barrel nut (Figure 2, Item 4) closes toward the bridle line, with barrel nut on right (Rigger's view), and is finger tight.



Figure 2. Connecting Bridle Line Link to Connector Link Loop on Sleeve.

END OF TASK

END OF WORK PACKAGE

FIELD MAINTENANCE

T-11 MAIN DROGUE ASSEMBLY
REPLACE

INITIAL SETUP:

Tools and Special Tools

None required

Materials/Parts

None required

Personnel Required

Parachute Rigger 92R1P (1)

References

WP 0007

Equipment Condition

Unpacked

REPLACE

1. Remove the girth hitch attaching the drogue parachute (Figure 1, Item 1) to the deployment sleeve (Figure 1, Item 2).
2. Discard defective drogue parachute and obtain a serviceable item from stock.

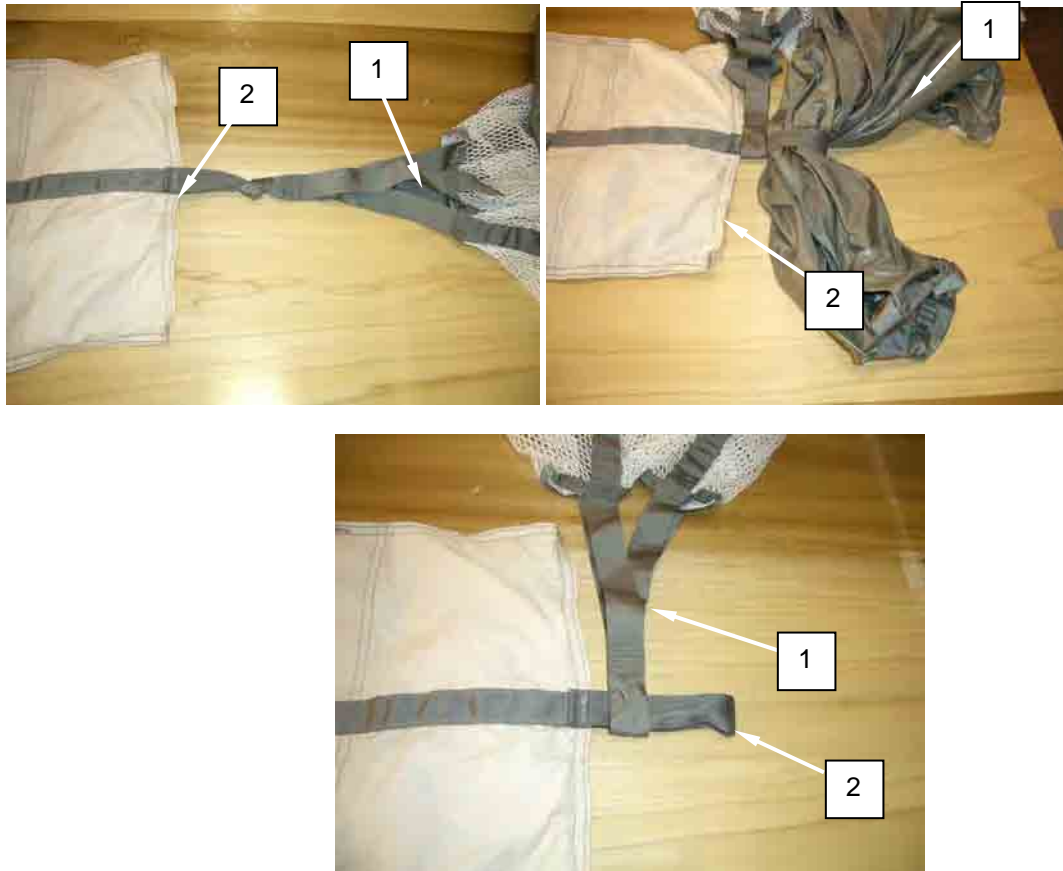

Figure 1. Remove Main Drogue Parachute.

REPLACE - CONTINUED

3. Attach drogue parachute IAW section entitled "Attach the Drogue" in WP 0007.

END OF TASK

END OF WORK PACKAGE

FIELD MAINTENANCE**T-11 MAIN SLIDER PANEL
REPLACE**

INITIAL SETUP:**Tools and Special Tools**

Needle, Upholsterer's, Curved, Size 5
(WP 0102, Item 32)
Scissors, 8 Inch (WP 0102, Item 48)
Stitch Removal Tool (WP 0102, Item 64)
Wrench, Adjustable, 8-inch (WP 0102, Item 73)

Personnel Required

Parachute Rigger 92R1P (2)

References

WP 0007

Materials/Parts

Tape, Lacing and Tying, Nylon, A-A-52080-B-3
(WP 0101, Item 41)

Equipment Condition

Unpacked

REPLACE

1. Place canopy in proper layout IAW WP 0007.

REPLACE - CONTINUED**CAUTION**

When cutting the lacing and tying tape, ensure surrounding webbing is not damaged.

2. Using the 8-inch adjustable wrench, loosen barrel nuts (Figure 1, Item 1) on connector links (Figure 1, Item 2).
3. Using stitch removal tool, cut lacing and tying tape (Figure 1, Item 3) that secures risers (Figure 1, Item 4) to connector links.
4. Remove connector links from risers.
5. Remove all suspension lines (Figure 1, Item 5) from connector links and discard connector links.

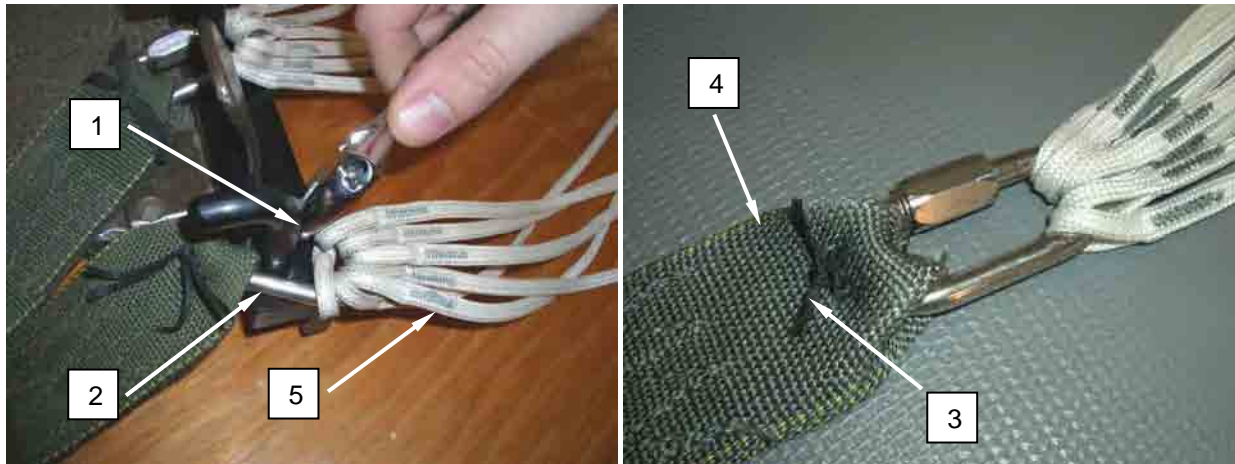

Figure 1. Removing Connector Links.

6. Obtain new connector links.
7. Place a connector link on each tension plate adapter hook so that the barrel nut faces the lower end of the table and to the outside (Figure 2).

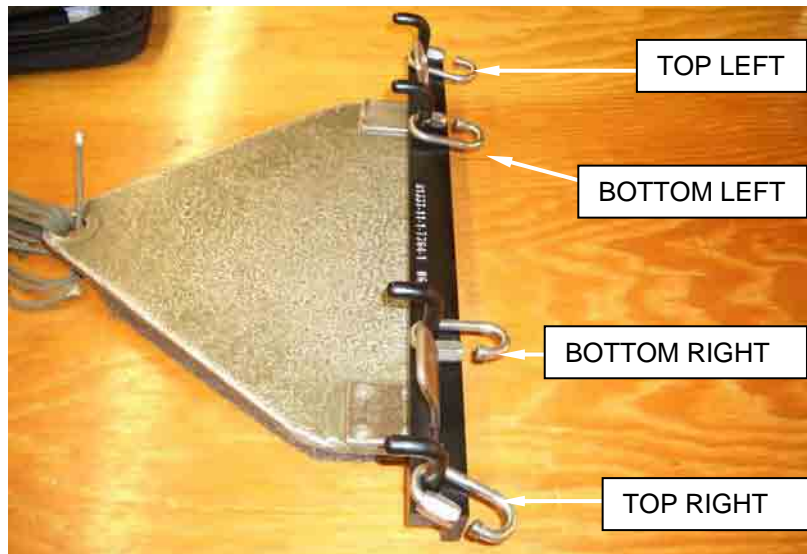

Figure 2. Tension Plate Adapter Layout.

REPLACE - CONTINUED

8. Remove the slider (Figure 3, Item 1) from the suspension lines (Figure 3, Item 2) by sliding the slider down the suspension lines away from the canopy until the slider is free of all suspension lines.



Figure 3. Removing Slider from Suspension Lines.

NOTE

Refer to Figure 4 at the end of this work package for visual reference to connector link and slider grommet numbers.

9. At the lower lateral band, locate suspension lines 1 through 7. Temporarily tie suspension lines together and place on canopy. This is the top-right line group.
10. Repeat step 9 for suspension lines 8 through 14. This is the bottom-right line group.
11. Repeat step 9 for suspension lines 28 through 22. This is the top-left line group.
12. Clear remaining suspension lines off the table.
13. Obtain serviceable slider from stock.
14. Orient the new slider on the table halfway between the connector link and canopy so that the data block is facing up and grommet marked 1 is lower right.

NOTE

When installing suspension lines onto connector link, ensure there are no twists in the suspension lines.

15. At the lower lateral band, locate suspension line 15. Trace suspension line 15 toward the slider, removing all twists.

REPLACE - CONTINUED**NOTE**

Ensure the slider remains flat and properly oriented. All suspension lines shall be routed from top to bottom. However, routing the bottom-left and bottom-right line groups under the slider after they are routed through the grommet will aid in proper line control. Running the top-left and top-right line groups back toward the canopy, while placing the suspension lines on top of the slider will also aid in proper line control.

16. Route suspension line 15 through slider grommet 15 from top to bottom and continuing under the slider.
17. Place suspension line 15 on the bottom-left connector link.
18. Repeat steps 15 through 17 for the remaining suspension lines in the bottom-left (15 through 21) line group.
19. Finger-tighten the bottom-left connector link.
20. Locate and untie the top-left line group (28 through 22).
21. At the lower lateral band, locate suspension line 28. Trace suspension line 28 toward the slider, removing all twists.
22. Route suspension line 28 through slider grommet 28 from top to bottom and continuing under the slider.
23. Place suspension line 28 on the top-left connector link.
24. Trace suspension line 28 back toward the canopy, placing the suspension line on top of the slider.
25. Repeat steps 21 through 24 for the remaining suspension lines in the top-left (28 through 22) line group.
26. Finger-Tighten the top-left connector link.
27. Locate and untie the bottom-right line group (14 through 8).
28. Repeat steps 15 through 19 for the bottom-right line group, starting with suspension line 14. The bottom-right line group connects to the bottom-right connector link.
29. Locate and untie the top-right line group (1 through 7).
30. Repeat steps 21 through 26 for the top-right line group, starting with suspension line 1. The top-right line group connects to the top-right connector link.
31. Attach main risers and perform line continuity check IAW WP 0007 section entitled "Attach the Main Risers to the Main Canopy" and "Perform a 100% Line Continuity Check." Torque connector links and tack risers IAW WP 0007 section entitled "Torque and Tack Main Risers."

REPLACE - CONTINUED

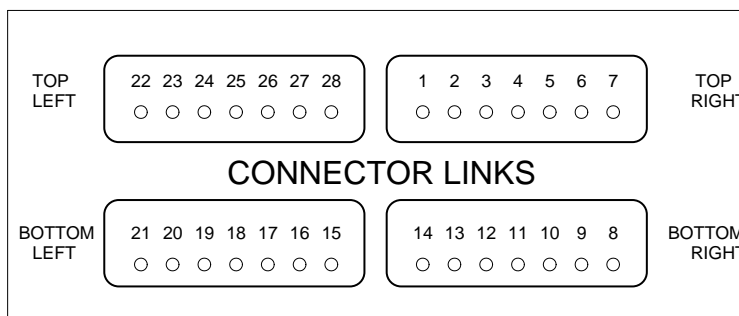
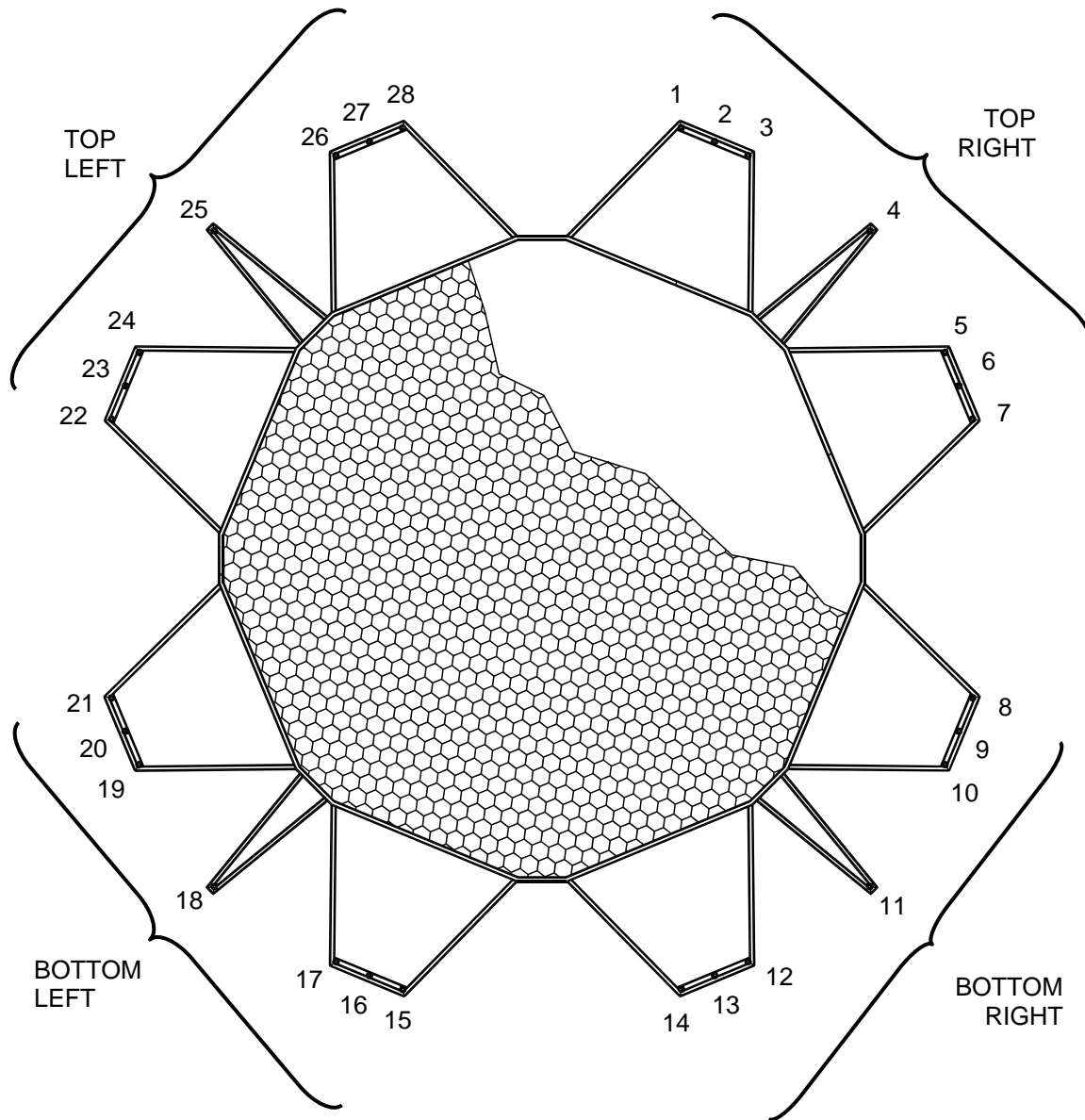

Figure 4. Running Suspension Lines through Slider Grommets.

END OF TASK

END OF WORK PACKAGE

FIELD MAINTENANCE
SLIDER PANEL METALLIC GROMMETS
REPAIR

INITIAL SETUP:**Tools and Special Tools**

File, Hand, Flat (WP 0102, Item 16)
Mallet, Rawhide (WP 0102, Item 29)
Press, Grommet and Eyelet, Hand Operated
(WP 0102, Item 41)
Punch and Die, Grommet Inserting, Size 0
(WP 0102, Item 43)
Scissors, 8 Inch (WP 0102, Item 48)
Stitch Removal Tool (WP 0102, Item 64)
Needle, Upholsterer's, Curved, Size 5
(WP 0102, Item 32)

Personnel Required

Parachute Riggers 92R1P (1)

References

WP 0007
WP 0025

Equipment Condition

Proper layout

Materials/Parts

Cloth, Abrasive (WP 0101, Item 10)
Tape, Lacing and Tying, Nylon, A-A-52080-B-3
(WP 0101, Item 41)

WARNING

The replacement of slider grommets is not authorized. If a slider grommet is damaged or missing, replace the slider IAW WP 0025. A slider with a defective grommet may result in death to the parachutist.

REPAIR**Repair Slider Grommets**

Remove burrs, sharp edges, rough spots, rust, or corrosion from a grommet by filing with a file or by buffing with an abrasive cloth.

REPAIR – CONTINUED**Reseat Slider Grommets**

1. Place the canopy in proper layout IAW WP 0007.
2. At the lower lateral band, locate the suspension line that runs through the damaged slider grommet.
3. Orient the canopy so that the affected suspension line is on top and runs free and clear from the lower lateral band to the connector link on top.
4. Trace affected suspension line to appropriate connector link.

NOTE

If the damaged suspension line is located on a bottom connector link, moving the top connector link to the opposite side of the pack table will aid in proper line continuity.

5. Using an 8-inch adjustable wrench, loosen barrel nut on the connector link with the affected suspension line.
6. Remove suspension lines from connector link sequentially and place suspension lines on an appropriate tool until the affected suspension line is reached.
7. Remove affected suspension line from connector link and pull up through damaged slider grommet.

CAUTION

Ensure the smooth side of grommet facing down towards the base.

8. Using a size 0 chuck and die, and a rawhide mallet, hammer until barrel collar (Figure 1, Item 1) is rolled down smooth on washer (Figure 1, Item 2).



Figure 1. Repair Grommet.

REPAIR – CONTINUED**NOTE**

If grommet barrel splits during hammering process, remove and replace the slider with a serviceable item from stock (WP 0025).

If fabric area around original grommet has been damaged, remove and replace the slider with a serviceable item from stock (WP 0025).

9. Check seating of grommet. If grommet can be turned by hand, repeat step 8 until grommet is firmly seated.

NOTE

When choosing a line adjacent to the damaged suspension line, ensure that both lines run to the same connector link. If possible, both suspension lines should also run through the same arm of the slider.

10. At lower lateral band, locate affected suspension line and one adjacent suspension line.
11. Using the adjacent suspension line as a guide, trace suspension line toward slide, removing all turns, tangles and twists.

WARNING

Proper layout of the slider and proper routing of the suspension line through the slider grommet is critical to proper performance. Failure to remove twists from the slider arms and failure to properly route could result in serious injury or death to the parachutist.

12. Route suspension line through the repaired slider grommet from top to bottom, ensuring the slider arms are free of twists.
13. Continue to trace the suspension line to the connector link.
14. Place suspension line on tool used in step 6, ensuring no turns, tangles or twists is introduced.
15. Continue to transfer suspension lines from the connector link to the appropriate tool as in step 6 until all suspension lines are transferred.
16. Using a stitch removal tool, cut and remove the lacing and tying tape on the riser that secures the connector link.
17. Remove connector link from riser and discard.
18. Obtain a new connector link from stock.
19. Position new connector link on the riser so the barrel faces inboard and tightens downward.
20. Install suspension lines onto new connector link sequentially from the tool until all lines are transferred.

REPAIR – CONTINUED

21. Finger tighten connector link barrel nut.
22. Perform a line continuity check and tack riser and tighten barrel nut IAW sections of WP 0007 entitled “Perform 100% Line Continuity Check” and “Torque and Tack Main Risers.”

END OF TASK**END OF WORK PACKAGE**

FIELD MAINTENANCE

ARM ASSEMBLY PANELS
REPAIR, REPLACE

INITIAL SETUP:

Tools and Special Tools

Needle, Upholsterer's, Curved, Size 3
(WP 0102, Item 31)
Ruler, Tab, Metal 16 Inches (WP 0102,
Item 46)
Scissors, 8 Inch (WP 0102, Item 48)
Sewing Machine, Light Duty (WP 0102,
Item 57)
Shears, Tailors, 12 inch (WP 0102, Item 61)
Stitch Removal Tool (WP 0102, Item 64)
Tape, Measuring (WP 0102, Item 65)
Yard Stick, 36 inches (WP 0102, Item 75)

Personnel Required

Parachute Rigger 92R1P (1)

References

WP 0016
WP 0018
WP 0030

Materials/Parts

Cloth, Parachute, Nylon, Low Permeability,
Ripstop Type IV (WP 0101, Item 12)
Pencil, China Marker, Yellow, A-A-87
(WP 0101, Item 30)
Pin, Steel, T, Size 24 (WP 0101, Item 32)
Thread, Nylon, V-T-295, Type I, Class A, Size
A, White/Natural (WP 0101, Item 53)
Thread Nylon, V-T-295, Type I or II, Class A,
Size E, FG504 (WP 0101, Item 54)

REPAIR

Repair arm sections by restitching, patching, or restenciling in accordance with WP 0016 and WP 0018. Stitching will be done as specified in WP 0016, Table 2.

If patching is required, a maximum of three patches per center section is authorized providing the area does not exceed 50% of the section. Any damage in excess of 50% will require a panel replacement.

Repair a damaged panel IAW WP 0016, section marked patching, using a light duty sewing machine size E thread, sewing 7 to 11 stitches per inch, $\frac{1}{16}$ -inch from folded edge. Finish with 2-inch locking stitch.

END OF TASK

REPLACE**NOTE**

Use of a 45-inch wide repair table will facilitate replacement procedures.

1. Invert the damaged panel. Smooth out the damaged panel on a repair table and secure the surrounding area with T-pins. As required, remove or lay aside items that may interfere with the panel replacement process (Figure 1).



Figure 1. Inverting Damaged Panel and Securing with T-pins.

2. Measure from the edge of the outside seam to the edge of outside of all seams surrounding the damaged panel. Cut new material of same type a minimum of 2 inches longer and wider than damage (Figure 2). If damaged panel is adjacent to mesh panel, mesh panel must be replaced IAW WP 0030.



Figure 2. Measuring from Edge of Outside Seam and Cutting New Material.

REPLACE - CONTINUED

NOTE

Warp and fill of new material must align with warp and fill of damaged section.

3. Center and pin the new material to the damaged panel. Measure 1 inch from the outside seams of the damaged panel and mark on new material. Cut along marked line (Figure 3).



Figure 3. Centering and Pinning New Material to Damaged Panel.

4. Fold the ends under 1 inch and secure with T-pins so that the rolled edge will match the width of the reinforcement tape. Secure the new material to the damaged panel with T-pins. Remove the T-pins securing the canopy to the table (Figure 4).



Figure 4. Folding Ends under and securing with T-pins.

REPLACE – CONTINUED

5. Sew the new material to the damaged section 1/16-inch in from the edge (Figure 5).



Figure 5. Sewing New Material to Damaged Panel.

6. Re invert the damaged panel. Place it on the repair table with new material facing down. Secure the panel to the table.
7. Mark $\frac{1}{2}$ inch in from the inside of the seam. Remove the damaged panel by cutting along the marked line (Figure 6).

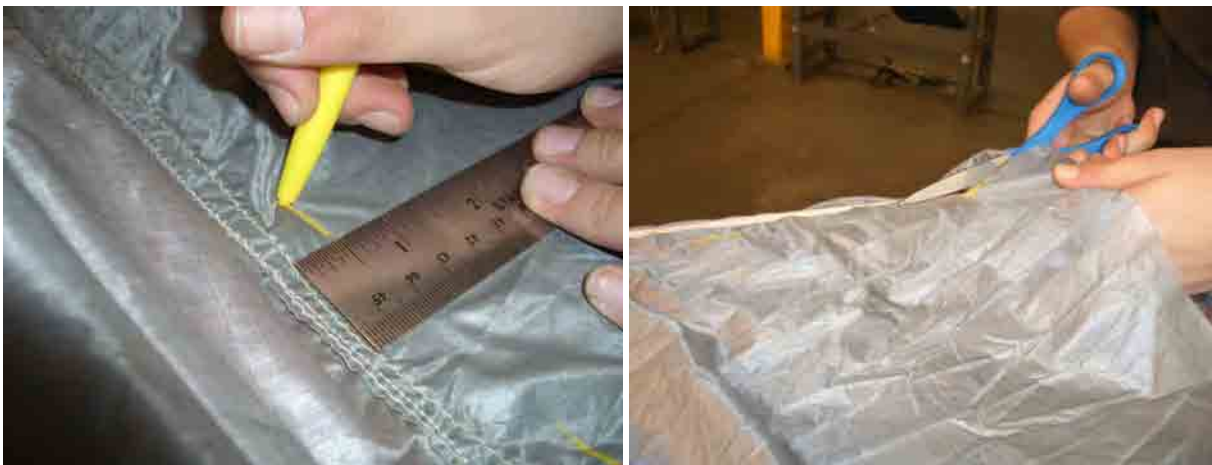

Figure 6. Removing Damaged Panel.

REPLACE – CONTINUED

8. Measure in $\frac{1}{2}$ inch from the inside corner at a 45 degree angle. Cut along marked lines (Figure 7).



Figure 7. Cutting in Corners at 45 Degree Angle.

REPLACE – CONTINUED

9. Fold along the inside edge under $\frac{1}{2}$ inch, incorporating the new material. Sew $\frac{1}{16}$ inch from the folded edge (Figure 8).



Figure 8. Folding along Inside Edge and Sewing along Folded Edge.

10. If necessary, re-stitch the mesh panel back to the canopy.

END OF TASK

END OF WORK PACKAGE

FIELD MAINTENANCE
CENTER SECTION ASSEMBLY
REPAIR, REPLACE

INITIAL SETUP:**Tools and Special Tools**

Ruler, Tab, Metal 16 Inches (WP 0102, Item 46)
 Needle, Upholsterer's, Curved, Size 3 (WP 0102, Item 31)
 Scissors, 8 Inch (WP 0102, Item 48)
 Sewing Machine, Double Needle (WP 0102, Item 54)
 Sewing Machine, Light Duty (WP 0102, Item 57)
 Shears, Tailors, 12 inch (WP 0102, Item 61)
 Stitch Removal Tool (WP 0102, Item 64)
 Tape, Measuring (WP 0102, Item 65)
 Yardstick, 36 Inches (WP 0102, Item 75)

Personnel Required

Parachute Rigger 92R1P (1)

References

WP 0016
 WP 0018
 WP 0029
 WP 0078
 WP 0079

Materials/Parts

Cloth, Parachute, Nylon, Low Permeability, Ripstop, Type IV FG504 (WP 101, Item 12)
 Pin, Steel, T, Size 24 (WP 0101, Item 32)
 Thread, Nylon, V-T-295, Type I or II, Class A, Size E, FG504 (WP 0101, Item 54)
 Pencil, China Marker, Yellow, A-A-87 (WP 0101, Item 30)
 Thread, Nylon, V-T-295, Type I, Class A, Size A, White/Natural (WP 0101, Item 53)

Equipment Condition

Unpacked

REPAIR

Repair center section assembly by re-stitching, patching, or re-stenciling, in accordance with WP 0016 and WP 0018. Stitching will be done as specified in WP 0016, Table 2.

1. If patching is required, a maximum of three patches per center panel is authorized providing the area does not exceed 50% of the panel. Any damage in excess of 50% will require a panel replacement.
2. If patch required encompasses packing loops or packing tabs, refer to WP 0078 and WP 0079 for appropriate procedures.
3. Panel replacements and patching against the center and apex reinforcement squares will require that the patch material cover three rows of stitching on the reinforcement. Holes in the reinforcement squares may be patched IAW WP 0029.
4. Repair a damaged panel IAW WP 0016, section marked patching, using a light duty sewing machine size E thread, sewing 7-11 stitches per inch, 1/16-inch from folded edge. Finish with 2-inch locking stitch.

END OF TASK

REPLACE**NOTE**

Use of a 45-inch wide repair table will facilitate replacement procedures.

If patch required encompasses packing loops or packing tabs, refer to WP 0078 and WP 0079 for appropriate procedures.

1. Invert the damaged panel. Smooth out the damaged panel on a repair table and secure the surrounding area with T-pins. As required, remove or lay aside items that may interfere with the panel replacement process (Figure 1).



Figure 1. Inverting Damaged Panel and Securing with T-pins.

2. Measure from the edge of the outside seam to the edge of outside of all seams surrounding the damaged panel. Cut new material of same type a minimum of 2 inches longer and wider than damaged panel (Figure 2).



Figure 2. Measuring from Edge of Outside Seam and Cutting New Material.

REPLACE - CONTINUED**NOTE**

Warp and fill of new material must align with warp and fill of damaged panel.

3. Center and pin the new material to the damaged panel. Measure 1 inch from the outside seams of the damaged panel and mark on new material. Cut along marked line. (Figure 3)



Figure 3. Centering and Pinning New Material to Damaged Panel.

NOTE

The new material should be pinned to the damaged panel.

4. Fold the ends under 1 inch and secure with T-pins so the rolled edge will match the width of the reinforcement tape. Secure the new material to the damaged panel with T-pins or by basting. Remove the T-pins securing the canopy to the table (Figure 4).



Figure 4. Folding Ends Under and Securing with T-pins.

REPLACE – CONTINUED

5. Sew the new material to the damaged panel $\frac{1}{16}$ inch in from the edge, finishing with a 2-inch locking stitch (Figure 5).



Figure 5. Sewing New Material to Damaged Panel.

6. Re-invert the damaged panel. Place it on the repair table with new material facing down. Secure the panel to the table. (Figure 6)



Figure 6. Re-inverting Damaged Panel and Placing on Repair Table.

REPLACE – CONTINUED

7. Mark $\frac{1}{2}$ inch in from the inside of the seam. Remove the damaged panel by cutting along the marked line (Figure 7).



Figure 7. Removing Damaged Panel.

8. Measure in $\frac{1}{2}$ inch from the inside corner at a 45 degree angle. Cut along marked lines (Figure 8).



Figure 8. Cutting in Corners at 45 Degree Angle.

REPLACE – CONTINUED

9. Fold along the inside edge under $\frac{1}{2}$ inch, incorporating the new material. Sew $\frac{1}{16}$ -inch from the folded edge (Figure 9).



Figure 9. Folding along Inside Edge and Sewing along Folded Edge.

10. If reinforcement panel is involved, re-stitch over existing stitch patterns (Figure 10).



Figure 10. Stitch Over Existing Stitch Patterns.

END OF TASK

END OF WORK PACKAGE

FIELD MAINTENANCE

CENTER SECTION ASSEMBLY REINFORCEMENT PANELS
REPAIR**INITIAL SETUP:****Tools and Special Tools**

Needle, Upholsterer's, Curved, Size 5
(WP 0102, Item 32)
Sewing Machine, Medium Duty (WP 0102, Item
59)
Shears, Tailors, 12-inch (WP 0102, Item 61)
Tape, Measuring (WP 0102, Item 65)

Personnel Required

Parachute Rigger 92R1P (1)

References

None required

Equipment Condition

Unpacked

Materials/Parts

Cloth, Duck, Nylon, Type III, Class 3, FG504,
PIA-C-7219A (WP 0101, Item 11)
Pin, Steel, T, Size 24 (WP 0101, Item 32)
Thread, Nylon, V-T-295, Type I or II, Class A,
Size E (WP 0101, Item 54)

REPAIR**Re-stitching.**

Re-stitch main canopy reinforcement panel using a light duty sewing machine and size E nylon thread that contrasts the color of the original stitching and material when possible. Re-stitch directly over the original stitch pattern as closely as possible with 7 to 11 stitches per inch. Lock each row of stitching 2 inches at each end.



Figure 1. Re-stitching Main Canopy Reinforcement Panel.

REPAIR - CONTINUED**NOTE**

Repair is limited to damage that is no closer than 1 inch to the outside edge of the reinforcement panel.

Repair a damaged reinforcement panel as follows:

1. Smooth out the damaged area on a repair table and secure the surrounding area with T-pins.
2. Measure the damaged area. Cut new material of same type and width 3 inches longer than the damaged area.
3. Place the new material centered over the damaged area, folding the ends under $\frac{1}{2}$ inch and securing with T-pins. Remove the T-pins surrounding the damaged area.
4. Using a light duty sewing machine with size E thread, sewing 7 to 11 stitches per inch, sew the new material over the damaged area $\frac{1}{16}$ -inch from the edges, finishing with a 2-inch locking stitch.

END OF TASK

END OF WORK PACKAGE

FIELD MAINTENANCE**T-11 LARGE AND SMALL MESH PANELS
REPAIR, REPLACE**

INITIAL SETUP:**Tools and Special Tools**

Knife, Pocket (WP 0102, Item 25)
Needle, Upholsterer's, Curved, Size 5
(WP 0102, Item 32)
Sewing Machine, Double Needle (WP 0102,
Item 54)
Sewing Machine, Light Duty (WP 0102, Item 57)
Sewing Machine, Zig-Zag (WP 0102, Item 60)
Shears, Tailors, 12 inch (WP 0102, Item 61)
Stitch Removal Tool (WP 0102, Item 64)

Personnel Required

Parachute Rigger 92R1P (1)

Equipment Condition

Unpacked

Materials/Parts

Pin, Steel, T, Size 24 (WP 0101, Item 32)
Thread, Nylon, V-T-295, Type I or II, Class A,
Size E (WP 0101, Item 50)

REPAIR

Re-stitching. Re-stitch main mesh panel using a light duty sewing machine and size E nylon thread that contrasts the color of the original stitching and material when possible. Re-stitch directly over the original stitch pattern as closely as possible with 7 to 11 stitches per inch. Lock each row of stitching 2 inches at each end.

REPAIR - CONTINUED

NOTE

Only straight tears can be repaired. Do not repair if parts of the mesh are missing.

No single repair may be more than 6 inches in length. No more than four repairs per mesh panel. No more than 12 inches of repaired damage in total. Repairs may not cross one another.

Repair a damaged mesh panel as follows (Figure 1).

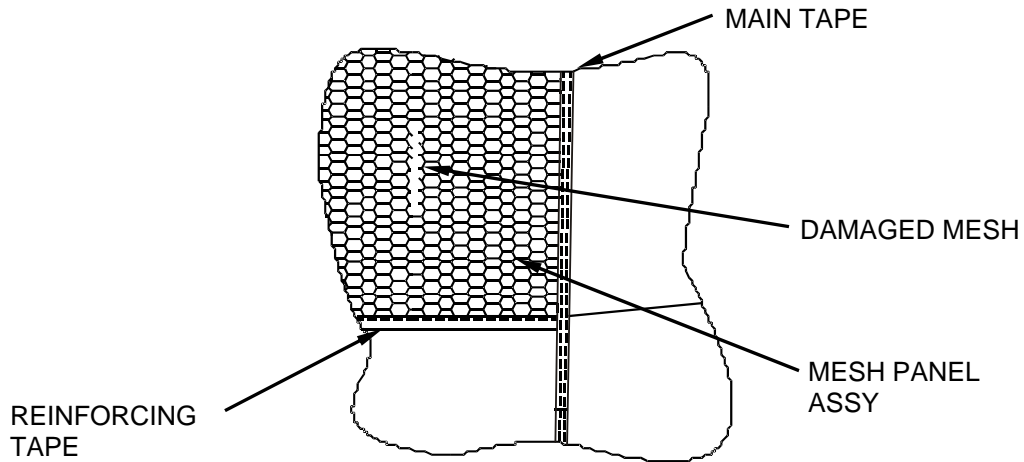

Figure 1. Repair Damaged Mesh Panel.

1. Invert canopy.
2. Pinch the torn edges together.
3. Using a zig-zag sewing machine set to a $\frac{3}{16}$ -inch wide stitch and size E nylon thread, start sewing at least 1 inch before the tear and at least $\frac{1}{8}$ inch in from the edge. Sew the length of the tear binding the torn edges together. Continue sewing to at least 1 inch past the tear (Figure 2).

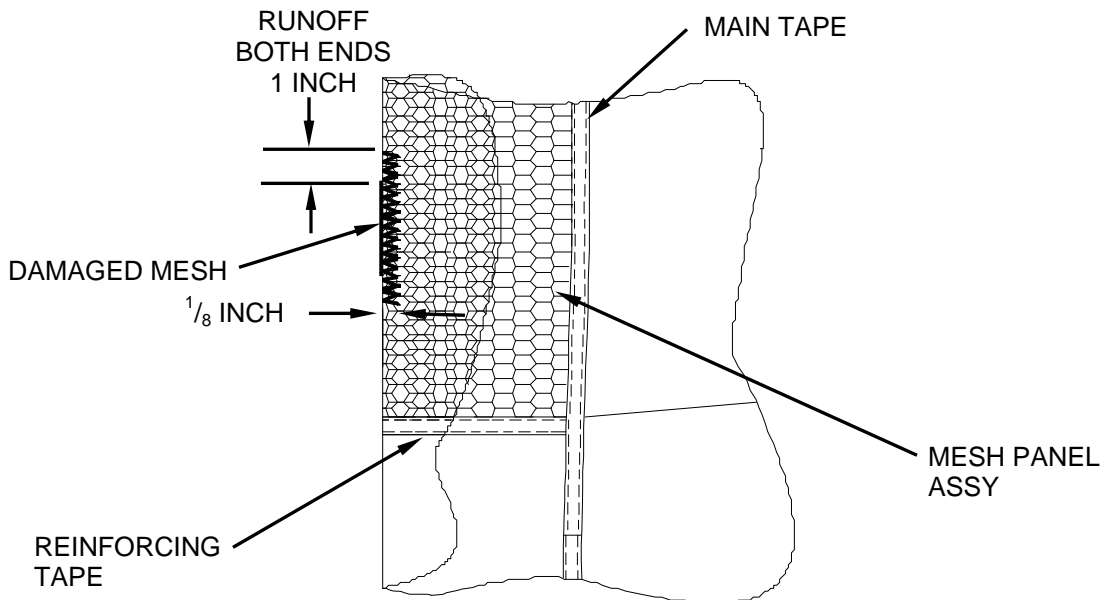

Figure 2. Sew before Tear.

REPAIR - CONTINUED

4. Verify that the repair is functional by using hand tension to pull the mesh perpendicular to the repair. If it pulls apart, attempt the repair again or replace the entire mesh panel.

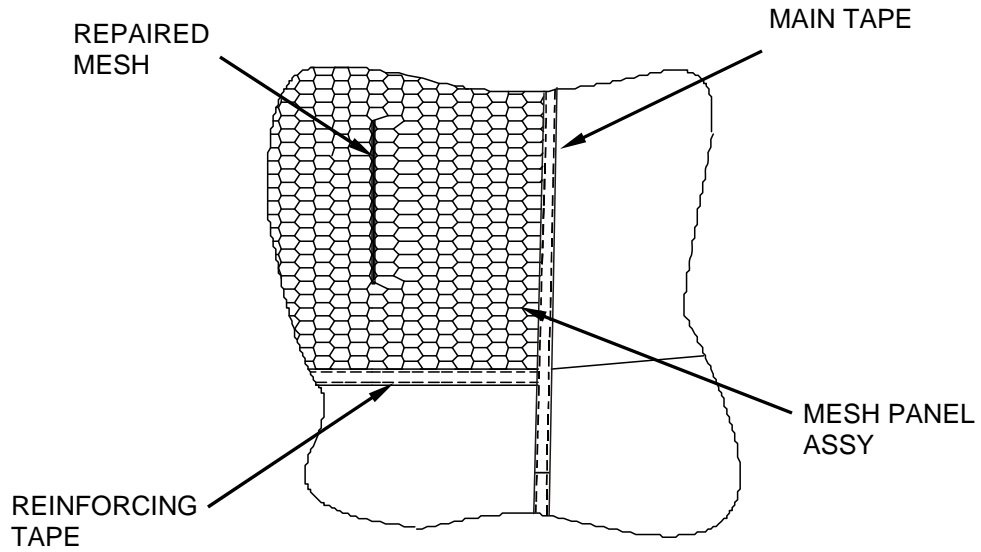

Figure 3. Verify Repair is Functional.

END OF TASK

REPLACE**NOTE**

Each mesh panel is a complete assembly that is sewn over a finished opening. Replacement entails removing the damaged mesh panel assembly and sewing a new one in the same location.

A single needle sewing machine may be used in place of a double needle sewing machine.

Replace a damaged mesh panel as follows:

1. Invert the damaged panel. Smooth out the damaged panel on a repair table and secure the surrounding area with T-pins. As required, remove or lay aside items that may interfere with the panel replacement process. Unstitch and carefully remove the damaged mesh panel assembly.
2. Center the new mesh panel assembly over the opening and secure with T-pins, ensuring that reinforcement tape is aligned with cross seams (Figure 4).



Figure 4. Centering New Mesh Panel over Opening and Securing with T-pins.

REPLACE - CONTINUED

3. Remove the T-pins securing the damaged area to the table.
4. Using a double needle sewing machine and size E nylon thread, begin sewing at least 2 inches before the end of the mesh panel main tape (Figure 5). Sew the entire main seam of the new mesh panel to the canopy following both rows of stitching on the seams. Sew past the other end by at least 2 inches. Repeat for the remaining seams.



Figure 5. Sewing New Mesh Panel in Place.

END OF TASK

END OF WORK PACKAGE

FIELD MAINTENANCE

DEPLOYMENT SLEEVE ASSEMBLY
REPAIR, REPLACE**INITIAL SETUP:****Tools and Special Tools**

Sewing Machine, Bartack, Industrial (WP 0102, Item 50)
Sewing Machine, Light Duty (WP 0102, Item 57)
Stitch Removal Tool (WP 0102, Item 64)

Personnel Required

Parachute Rigger 92R1P (1)

Equipment Condition

Unpacked

Materials/Parts

Thread, Nylon, V-T-295, Type I or II, Class A, Size E (WP 0101, Item 50)

References

WP 0007
WP 0016
WP 0065

REPAIR**NOTE**

Patching is not authorized for the deployment sleeve.

Restitching

1. Re-stitch IAW WP 0016 using a light duty sewing machine with size E thread, sewing 7 to 11 stitches per inch (Figure 1).



Figure 1. Light Duty Sewing Machine Re-stitching.

REPAIR - CONTINUED**CAUTION**

Stitch removal requirements will vary according to the type of item being repaired. Due to the unique type of stitch formations found on the T-11 Personnel Parachute System, use of a stitch removal tool is mandated when removing Bartack or Box X stitch formations.

NOTE

Due to the length of the deployment sleeve, damage will be repaired if the damaged area is accessible with the sewing machine. Inaccessible damage will require replacement of the deployment sleeve.

Bartacks are used for the drogue attachment point and the bridle line stowage bars.

2. If bartack stitching requires repair, bartacks will be completely removed and replaced with new bartack with same stitch length and width.
3. No patches are authorized on the cotton sleeve.
4. Allowable damage is acceptable under the following conditions:
 - a. Holes cannot exceed 1 inch in diameter.
 - b. Holes cannot be within 12 inches of one another.
5. All other damage will require replacement of the cotton sleeve.

END OF TASK**Darning****NOTE**

Darning is limited to holes no larger than $\frac{3}{4}$ inch in diameter.

Refer to WP 0016.

END OF TASK**Replacement of Hook and Pile Tape Fastener**

Refer to WP 0065.

END OF TASK**REPLACE**

1. Pull bridle back through sleeve toward the apex hook and remove bridle assembly.
2. Remove bridle assembly from main canopy.
3. Refer to WP 0007 to attach new deployment sleeve.

END OF TASK**END OF WORK PACKAGE**

FIELD MAINTENANCE

**MAIN CANOPY SUSPENSION LINE ATTACHING LOOP
REPAIR, REPLACE**

INITIAL SETUP:**Tools and Special Tools**

Crowfoot Attachment, Socket Wrench, 3/8 inch Drive, Open End, 7/16 inch (WP 0102, Item 12)
 Heated Blade Cutter (WP 0102, Item 18)
 Sewing Machine, Bartack, Industrial (WP 0102, Item 50)
 Sewing Machine, Medium Duty (WP 0102, Item 59)
 Shears, Tailors, 12 inch (WP 0102, Item 61)
 Stitch Removal Tool (WP 0102, Item 64)
 Tape Measure (WP 0102, Item 65)
 Ruler, Tab, Metal 16 Inches (WP 0102, Item 46)
 Wrench, Adjustable, 8 inch (WP 0102, Item 73)
 Wrench, Torque, 0-300 inch Pounds (WP 0102, Item 74)

Personnel Required

Parachute Rigger 92R1P (1)

Equipment Condition

Parachute in proper layout with damaged suspension line attaching loop on top.

Reference

WP 0007
 WP 0016

Materials/Parts

Thread, Nylon Type I or II, Size E, Natural (WP 0101, Item 50)
 Thread, Nylon, V-T-295, Type I or II, Class A, Size E, FG504(WP 0101, Item 54)
 Webbing, Nylon, Type I, Class 2, 9/16 inch wide, Natural (WP 0101, Item 63)

REPAIR

Only re-stitching of broken stitching is authorized. Refer to WP 0016 for sewing procedure.

END OF TASK

REPLACE**CAUTION**

Do not use vise grips or other type pliers to hold connector link body when tightening, as damage to connector link can occur.

Ensure that only the damaged line attachment point is cut away in the following step and that the suspension line is not damaged. If the suspension line is damaged, it must be replaced.

NOTE

Using a screwdriver, passed through the connector link, may help to stabilize it while applying torque.

1. Remove damaged suspension line attaching loop (Figure 1, Item 1) by cutting loop with a pair of shears even with the lower lateral band. Do not cut suspension line or lower lateral band.
2. Pin suspension line to canopy.
3. Discard damaged suspension line attaching loop. If previously repaired, carefully remove stitching and remove damaged suspension line attaching loop.



Figure 1. Remove Damaged Suspension Line Attaching Loop.

REPLACE – CONTINUED

WARNING

Take care when handling the heated blade cutter to avoid burns. Failure to do so may result in injury to personnel.

4. Using a hot knife, cut a 4 $\frac{3}{4}$ -inch length of $\frac{9}{16}$ -inch wide Type I webbing. Fold the new suspension line loop in half.



Figure 2. Measure and Cut Type I Webbing.

5. Measure 1 $\frac{1}{4}$ -inch from folded end and mark on each side.
6. Place the new suspension line loop over the previously damaged loop with the open end sandwiching the lower lateral band forming a 1 $\frac{1}{4}$ -inch loop.

NOTE

Two parallel $\frac{1}{8}$ - x $\frac{3}{4}$ -inch, 42-stitch bartacks may be used in place of the box X stitch pattern.

7. Using the box X sewing machine, size E nylon thread, 7 to 11 stitches per inch, sew in place (refer to WP 0016 for box X stitch pattern).



Figure 3. Attach New Suspension Line Loop (Bartack Option Shown).

8. Place the canopy in proper layout on the repair table or repair surface IAW WP 0007.

REPLACE – CONTINUED**NOTE**

When choosing a line adjacent to the damaged suspension line, ensure that both lines run to the same connector link. If possible, both suspension lines should also run through the same arm of the slider.

9. Orient the canopy so that the suspension line from the repaired suspension line attaching loop and one adjacent line are on top and run free and clear from the lower lateral band to the connector link .
10. Using an 8-inch adjustable wrench, loosen the barrel nut on the appropriate connector link.
11. Using a stitch removal tool, cut and remove the lacing and tying tape on the riser that secures the connector link.
12. Remove the suspension lines from the connector link one at a time and place on an appropriate tool until the affected suspension line is reached.
13. Remove affected suspension line from connector link.
14. Pull affected suspension line out of slider and unpin from canopy.
15. Girth hitch the suspension line to the new suspension line attaching loop.
16. Using the adjacent suspension lines as a guide, trace the new suspension line toward the slider, removing all turns, tangles, twists or knots.

**WARNING**

Proper layout of the slider and proper routing of the suspension line through the slider grommet is critical to proper performance. Failure to remove twists from the slider arms and failure to properly route could result in serious injury or death to the parachutist.

17. Route the suspension line through the appropriate slider grommet from top to bottom, ensuring the slider arms are free of twists.
18. Continue tracing the suspension line to the connector link.
19. Place suspension line on appropriate tool as indicated in step 12.
20. Continue removing suspension lines from connector link, as in step 12, until all suspension lines are removed.
21. Using a stitch removal tool, cut and remove the lacing and tying tape on the riser that secures the connector link.
22. Remove connector link from riser and discard.
23. Obtain new connector link from stock.
24. Position new connector link on the riser so the barrel faces inboard and tightens downward.

REPLACE – CONTINUED

25. Install suspension lines onto new connector link sequentially from the tool until the damaged line is reached.
26. Finger tighten barrel nut.
27. Perform a line continuity check and tack riser and tighten barrel nut IAW sections of WP 0007 entitled "Perform 100% Line Continuity Check" and "Torque and Tack Main Risers."

END OF TASK**END OF WORK PACKAGE**

FIELD MAINTENANCE

MAIN SEAMS
REPAIR

INITIAL SETUP:

Tools and Special Tools

Sewing Machine, Double Needle (WP 0102, Item 54)
 Sewing Machine, Light Duty (WP 0102, Item 57)
 Shears, Tailors, 12 inch (WP 0102, Item 61)
 Tape Measuring (WP 0102, Item 65)
 Ruler, Tab, Metal 16 Inches (WP 0102, Item 46)

Personnel Required

Parachute Rigger 92R1P (1)

Equipment Condition

Unpacked

Materials/Parts

Pencil, China Marker, Yellow, A-A-87 (WP 0101, Item 30)
 Pin, Steel, T, Size 24 (WP 0101, Item 32)
 Tape, Textile, Nylon Type III, Class 1A, 1-inch Wide, Natural (WP 0101, Item 45)
 Thread, Nylon, V-T-295, Type I or II, Class A, Size E, FG504 (WP 0101, Item 54)
 Webbing, Nylon, Type I, 9/16-inch wide (WP 0101, Item 65)

References

WP 0016

REPAIR

Re-stitching. Re-stitch lower lateral band using a light duty sewing machine and size E nylon thread that contrasts the color of the original stitching and material when possible. Re-stitch directly over the original stitch pattern as closely as possible with 7 to 11 stitches per inch. Lock each row of stitching 2 inches at each end.

Repairing a Main Seam

1. Smooth out the damaged area on a repair table and secure the surrounding area with T-pins.
2. Measure the damaged seam (Figure 1). Cut new material of same panel type and width 9 inches longer than the damaged seam.



Figure 1. Measure the Damaged Area.

REPAIR - CONTINUED

3. Place the new material centered over the damaged seam folding the ends under ½ inch and secure with T-pins (Figure 2). Remove the T-pins surrounding the damaged seam.

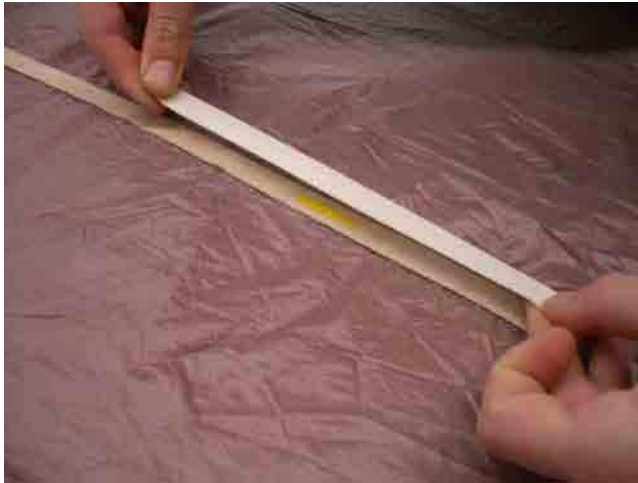

Figure 2. Place the New Material Centered over the Damaged Area.

4. Using a light duty sewing machine, size E nylon thread, 7 to 11 stitches per inch, sew the new material over the damaged seam as per the original stitching (Figure 3). Overstitch by 2 inches past the new material.



Figure 3. Sew the New Material over the Damaged Area.

END OF TASK

END OF WORK PACKAGE

FIELD MAINTENANCE

LOWER LATERAL BAND
REPAIR

INITIAL SETUP

Tools and Special Tools

Sewing Machine, Light Duty (WP 00102, Item 57)
 Shears, Tailors, 12 Inch (WP 00102, Item 61)
 Stitch Removal Tool (WP 00102, Item 64)
 Tape, Measuring (WP 00102, Item 65)
 Ruler, Tab, Metal 16 Inches (WP 0102, Item 46)

Personnel Required

Parachute Rigger 92R1P (1)

Equipment Condition

Unpacked

Materials/Parts

Pencil, China Marker, Yellow, A-A-87 (WP 0101, Item 30)
 Pin, Steel, T, Size 24 (WP 0101, Item 32)
 Tape, Textile, Nylon, Type II, Class 1A, 1 inch wide, FG504 (WP 00101, Item 44)
 Thread, Nylon, V-T-295, Type I or II, Class A, Size E, FG504 (WP 00101, Item 54)

REPAIR

Re-stitching. Re-stitch lower lateral band using a light duty sewing machine and size E nylon thread that contrasts the color of the original stitching and material when possible. Re-stitch directly over the original stitch pattern as closely as possible with 7 to 11 stitches per inch. Lock each row of stitching 2 inches at each end.

CAUTION

Stitch removal requirements will vary according to the type of item being repaired. Due to the unique type of stitch formations found on the T-11 Personnel Parachute System, use of a stitch removal tool is mandated when removing Bartack or Box X stitch formations.

If bartack stitching requires repair, bartacks will be completely removed and replaced with a new bartack with the same stitch length and width.

Repair Lower Lateral Band

Repair the lower lateral band with the exception of the following limitations:

- a. Damaged tape cannot be cut more than 50 percent.
- b. Damaged area not to exceed 6 inches.
- c. No more than one repair per arm.

REPAIR – CONTINUED

Repair a lower lateral band as follows:

1. Smooth out the damaged area on a repair table and secure the surrounding area with T-pins (Figure 1).



Figure 1. Smooth Out Damaged Area on a Repair Table.

2. Measure the damaged area. Cut new material of same type and width 9 inches longer than the damaged area (Figure 2).

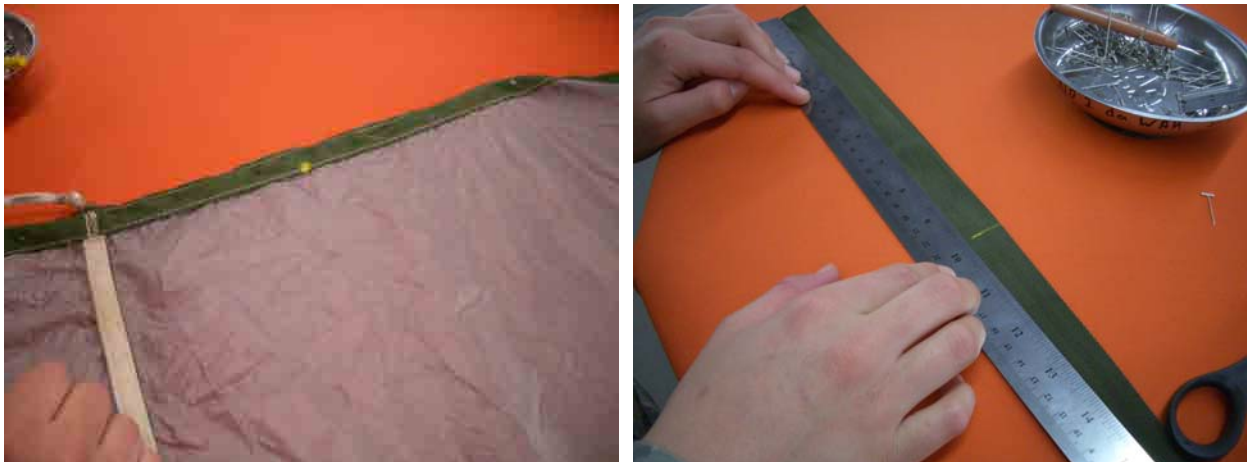

Figure 2. Measure Damaged Area and Cut New Material.

REPAIR – CONTINUED

3. Place the new material centered over the damaged area folding the ends under $\frac{1}{2}$ inch and secure with T-pins. Remove the T-pins surrounding the damaged area (Figure 3).



Figure 3. Place New Material Centered over Damaged Area.

4. Using a light duty sewing machine, size E nylon thread, 7 to 11 stitches per inch, sew the new material over the damaged area as per the original stitching. Overstitch by 2 inches past the new material (Figure 4).



Figure 4. Sew New Material over Damaged Area.

END OF TASK

END OF WORK PACKAGE

FIELD MAINTENANCE

BRIDLE ATTACHMENT ASSEMBLY
REPAIR, REPLACE**INITIAL SETUP:****Tools and Special Tools**

Heated Blade Cutter (WP 0102, Item 18)
 Sewing Machine, Bartack, Industrial (WP 0102, Item 50)
 Shears, Tailors, 12 inch (WP 0102, Item 61)
 Stitch Removal Tool (WP 0102, Item 64)
 Tape, Measuring (WP 0102, Item 65)
 Wrench, Adjustable, 8 inch (WP 0102, Item 73)
 Ruler, Tab, Metal 16 Inches (WP 0102, Item 46)

Personnel Required

Parachute Rigger 92R1P (1)

Reference

WP 0016

Materials/Parts

Pencil, China Marker, Yellow, A-A-87 (WP 0101, Item 30)
 Ring, No. 3 (WP 0101, Item 34)
 Thread, Nylon, V-T-295, Type I or II, Class A, Size E, FG504 (WP 0101, Item 54)
 Webbing, Nylon, Type I, 9/16-inch wide, Natural (WP 0101, Item 65)

Equipment Condition

Unpacked

REPAIR

If bartack stitching requires repair, bartacks will be completely removed and replaced with new bartack with same stitch length and width. Re-stitch using a bartack sewing machine with size E thread, 42-stitch bartack. Refer to WP 0016 for complete bartack information.

END OF TASK

REPLACE**CAUTION**

Stitch removal requirements will vary according to the type of item being repaired. Due to the unique type of stitch formations found on the T-11 Personnel Parachute System, use of a stitch removal tool is mandated when removing Bartack, Box X, or Double Box X stitch formations.

NOTE

Bartacks are used for the drogue attachment point and the bridle line stowage bars.

1. Mark the placement and carefully remove damaged apex bridle attachment assembly (Figure 1) by unpicking the bartacks that hold the bridle attachment assembly to the canopy. Remove all loose stitching. If the ring is not distorted or damaged, reuse this ring for the new bridle attachment assembly.



Figure 1. Removing the Damaged Apex Bridle Attachment Assembly.

REPLACE – CONTINUED

- Using a heated blade cutter, cut two, 7-inch lengths of webbing (Figure 2, Item 1). Place both lengths of webbing on top of each other and run them through the ring (Figure 2, Item 2).

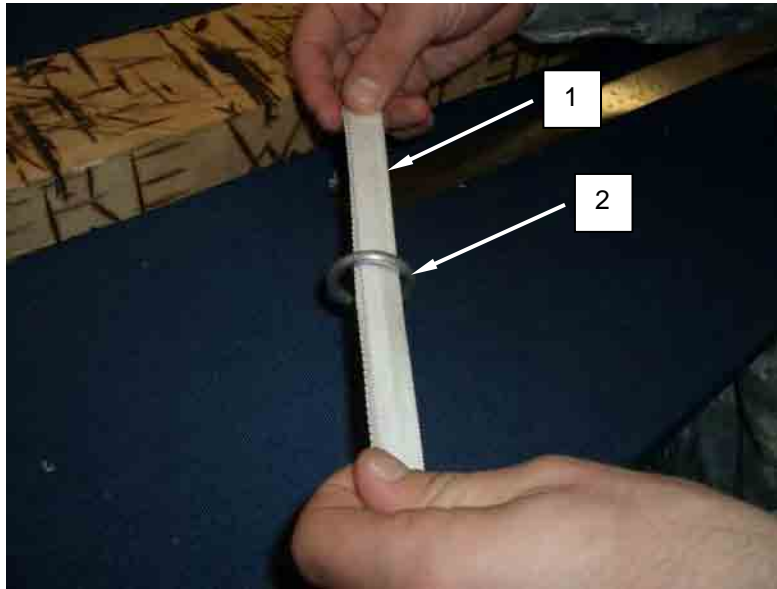

Figure 2. Cutting Two Lengths of Webbing with Heated Blade Cutter.

- Fold the webbing in half forming a loop around the ring (Figure 3, Item 1). Place a $\frac{1}{8}$ - x $\frac{1}{2}$ -inch, 42-stitch bartack (Figure 3, Item 2) the width of the webbing 1 inch from the end of the loop trapping the ring (Figure 3, Item 1) inside the loop forming a new bridle attachment assembly (Figure 3, Item 3).

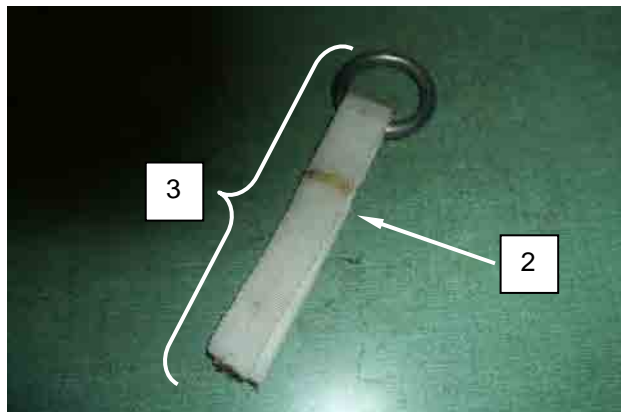
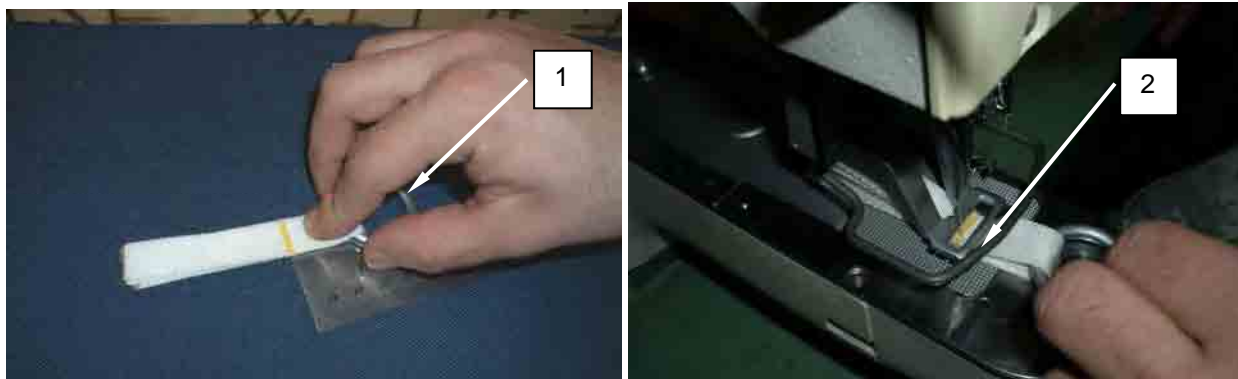

Figure 3. Fabricating a New Bridle Attachment Assembly.

REPLACE - CONTINUED

4. Separate the four running ends of the new bridle loop assembly and fold under $\frac{1}{2}$ inch.
5. Place the new bridle loop assembly on the canopy in the same place as the original loop by locating the marks made in step 1 and sew with two $\frac{1}{8}$ - x $\frac{1}{2}$ -inch, 42-stitch bartacks $\frac{1}{8}$ inch from the end. The second bartack will be $\frac{1}{8}$ inch from the first (Figure 4).



Figure 4. Attaching the New Bridle Attachment Assembly to the Canopy.

END OF TASK

END OF WORK PACKAGE

FIELD MAINTENANCE**T-11 MAIN RISER SET
REPAIR, REPLACE****INITIAL SETUP:****Tools and Special Tools**

Adapter, Tension Plate (WP 0102, Item 1)
 Knife, Pocket (WP 0102, Item 25)
 Plate, Tension, Parachute Packing (WP 0102,
 Item 37)
 Sewing Machine, Medium Duty (WP 0102,
 Item 59)
 Screwdriver, Flat-tip, 1/4-Inch (WP 0102,
 Item 49)
 Wrench, Adjustable, 8-inch (WP 0102, Item 73)

Personnel Required

Parachute Rigger 92R1P (1)

References

WP 0007

Equipment Condition

Unpacked

Materials/Parts

Thread, Nylon, V-T-295, Type I or II, Class A,
 Size E, FG504 (WP 0101, Item 54)
 Webbing, Nylon, Type I, 9/16 inch wide, FG504
 (WP 0101, Item 65)

REPAIR**Re-stitching**

Re-stitch main risers using a medium duty sewing machine and size E nylon thread that contrasts the color of the original stitching and material when possible. Re-stitch directly over the original stitch pattern as closely as possible with 7 to 11 stitches per inch. Lock each row of stitching 2 inches at each end.

END OF TASK

REPLACE**Remove Main Risers from Main Canopy**

1. Place canopy in proper layout.

CAUTION

When cutting the lacing and tying tape, ensure surrounding webbing is not damaged.

Do not use vise grips or other type pliers to hold connector link body when tightening, as damage to connector link can occur.

NOTE

Using a screwdriver passed through the connector link may help to stabilize it while applying torque.

2. Place the left set of connector links (Figure 1, Item 1) on the left post (Figure 1, Item 2) of the tension plate adapter (Figure 1, Item 3) and the right set of connector links (Figure 1, Item 4) on the right post (Figure 1, Item 5) of the tension plate adapter.

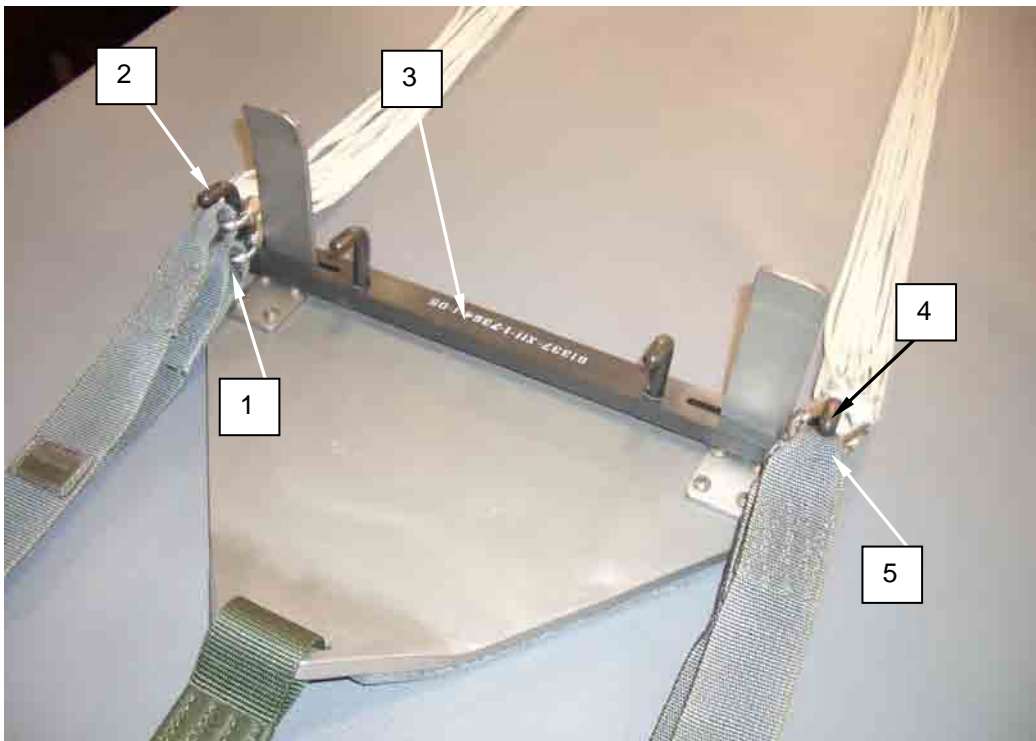

Figure 1. Place Connector Links on Tension Plate Adapter.

3. Cut tape, lacing and tying, that secures risers to the connector links.
4. Using an 8-inch adjustable wrench, completely open the barrel nuts.
5. Remove risers from connector links, keeping suspension lines attached to connector links.
6. Remove the log record book from the old risers and retain for transfer to new risers.

END OF TASK

REPLACE – CONTINUED**Attach the Main Risers to the Main Canopy**

1. Layout the new main risers (Figure 2, Item 1) directly behind the left (Figure 2, Item 2) and right (Figure 2, Item 6) connector link groups ensuring that there are no twists. Ensure that the label and slip assist tabs are facing up.

NOTE

Connector link barrel nuts must be oriented so they face inboard and tighten downward.

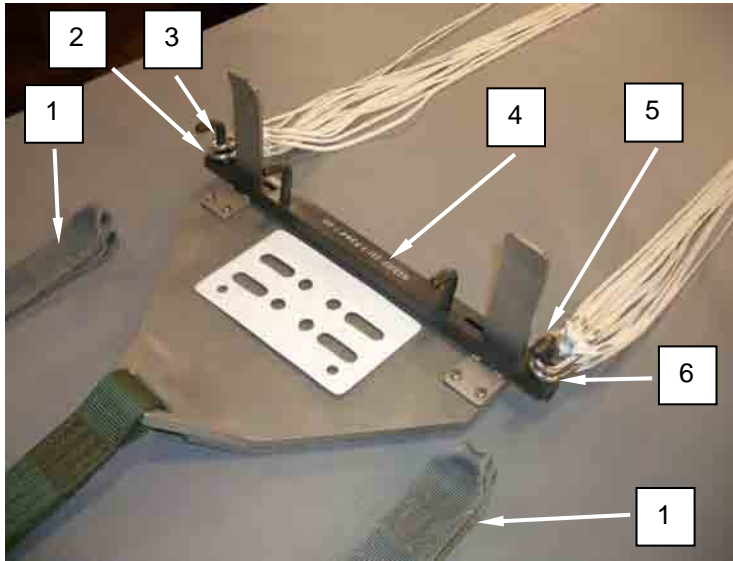

Figure 2. Lay Out Riser Assembly.

2. Obtain new connector links from stock.
3. Place new connector links on risers.
4. Starting with one riser, rotate riser sideways on the long portion of the connector link opposite the barrel nut.

NOTE

The intermediate step of transferring suspension lines to an appropriate tool ensures that suspension line sequence is maintained. Transferring directly from connector link to connector link will result in a reverse sequence.

5. Transfer suspension lines off the old connector link sequentially to an appropriate tool.
6. Sequentially transfer suspension lines from tool to new connector link.
7. Finger tighten new connector link.
8. Repeat steps 4 through 6 for remaining connector links.
9. Discard old connector links.

REPLACE - CONTINUED

10. Perform a line continuity check, tack riser and tighten barrel nut IAW sections of WP 0007 entitled "Perform 100% Line Continuity Check" and "Torque and Tack Main Risers."
11. Reattach log record IAW WP 0007, section entitled "Parachute Log Record". Make required repair entries to Log Record IAW WP 0007, section entitled "Completing a Log Record Entry."

END OF TASK**END OF WORK PACKAGE**

FIELD MAINTENANCE**LOG RECORD POCKET
REPAIR, REPLACE**

INITIAL SETUP:**Tools and Special Tools**

Sewing Machine, Medium Duty (WP 0102,
Item 59)
Stitch Removal Tool (WP 00102, Item 64)

Personnel Required

Parachute Rigger 92R1P (1)

Materials/Parts

Pencil, China Marker, Yellow, A-A-87
(WP 0101, Item 30)
Thread, Nylon, V-T-295, Type I or II, Class A,
Size E, FG504 (WP 0101, Item 54)

Equipment Condition

Unpacked

REPAIR**Re-stitching**

Re-stitch log record pocket using a medium duty sewing machine and size E nylon thread that contrasts the color of the original stitching and material when possible. Re-stitch directly over the original stitch pattern as closely as possible with 7 to 11 stitches per inch. Lock each row of stitching 2 inches at each end.

END OF TASK**REPLACE****Replace Log Record Pocket**

1. Mark location of log record pocket. Carefully remove the log record pocket from the riser.
2. Discard and obtain serviceable item from stock.
3. Reposition the new log record pocket in its original position. Using a medium duty sewing machine and size E nylon thread, 7 to 11 stitches per inch, sew in place as per original stitching.

END OF TASK**END OF WORK PACKAGE**

FIELD MAINTENANCE

T-11 MAIN PACK TRAY
REPAIR, REPLACE

INITIAL SETUP:

Tools and Special Tools

Knife, Pocket (WP 0102, Item 24)
 Needle, Upholsterer's, Curved, Size 3 (WP 0102, Item 29)
 Needle, Upholsterer's, Curved, Size 5 (WP 0102, Item 30)
 Sewing Machine, Bartack, Industrial (WP 0102, Item 50)
 Sewing Machine, Darning (WP 0102, Item 52)
 Sewing Machine, Light Duty (WP 0102, Item 57)
 Wrench, Adjustable, 8-inch (WP 0102, Item 73)

Personnel Required

Parachute Rigger 92R1P (1)

Materials/Parts

Band, Rubber, Parachute, 1-¼-inch, 3/8-inch Wide (WP 0101, Item 2)
 Band, Rubber, Parachute, 2-inch Long, 3/8-inch Wide (WP 0101, Item 3)
 Lacing and Tying, Nylon, (WP 0101, Item 42)
 Thread, Nylon, V-T-295, Type I or II, Class A, Size E, FG504 (WP 0101, Item 54)

References

WP 0016

Equipment Condition

Unpacked

REPAIR

Re-stitching. Re-stitch main pack tray using a light duty sewing machine and size E nylon thread that contrasts the color of the original stitching and material when possible. Re-stitch directly over the original stitch pattern as closely as possible with 7 to 11 stitches per inch. Lock each row of stitching 2 inches at each end.

If bartack stitching requires repair, bartacks will be completely removed and a new bartack will be replaced with the same stitch length and width.

Darn Main Pack Tray

NOTE

For darning holes, repair of holes are limited to ¾ inch in diameter.

Refer to WP 0016 for General Parachute Repairs procedures.

Repair Main Pack Tray

Refer to WP 0016 General Parachute Repair for patching. Refer to applicable work packages for additional items needing repair.

REPAIR - CONTINUED**Splicing**

Splice an edge binding (an unlimited number of times) as follows:

1. Cut a length of $\frac{3}{4}$ -inch wide nylon tape 2 inches longer than damaged area.
2. Make a $\frac{1}{2}$ -inch fold under on each end of tape length.
3. Center and fold tape lengthwise over edge of the damaged area. Secure splice by stitching (a box stitch formation, $\frac{1}{16}$ inch in from each edge, along full length of splice material.) Replace with two rows of stitching overlapping the original stitching 1 inch past the splice creating a locking stitch on both ends.

END OF TASK**REPLACE****Remove Harness Assembly from Unserviceable Pack Tray**

1. If not already done, remove the canopy and risers from the harness by opening the canopy release assemblies.
2. Layout the pack tray (Figure 1, Item 1) and harness assembly (Figure 1, Item 2) assembly on the pack table with the harness assembly facing up.
3. Remove the harness assembly (Figure 1, Item 2) from the pack tray (Figure 1, Item 1) by unsnapping the diagonal back strap retainer (Figure 1, Item 3) and remove from behind the diagonal back strap keeper (Figure 1, Item 4). Remove from the diagonal back strap sizing channels (Figure 1, Item 5) on both the left and right.



Figure 1. Remove Harness Assembly from Pack Tray.

REPLACE - CONTINUED

4. Remove the horizontal back strap (Figure 2, Item 1) from the pack tray (Figure 2, Item 2) by unsnapping the horizontal back strap retainer snap fasteners (Figure 2, Item 3). Remove the horizontal back strap retainers (Figure 2, Item 4) from behind the horizontal back strap keeper (Figure 2, Item 5). Remove harness assembly (Figure 2, Item 6).

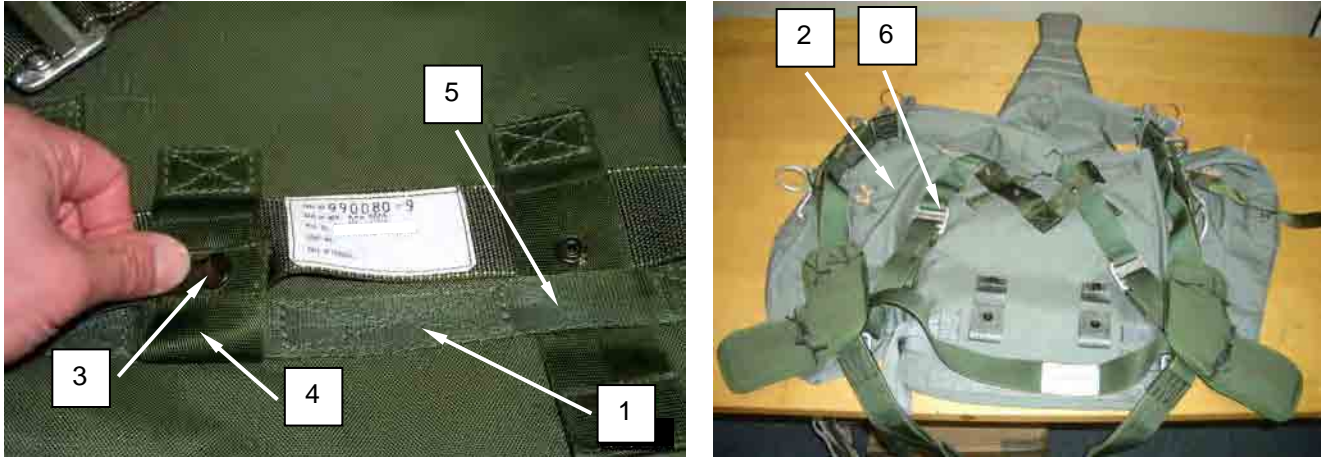

Figure 2. Removing Unserviceable Pack Tray.

END OF TASK

REPLACE – CONTINUED**Routing and Securing Main Closing Loop**

1. Route the main closing loop (Figure 3, Item 1) under the main closing loop protective cover (Figure 3, Item 2) and through the grommet (Figure 3, Item 3).
2. Rotate the main closing loop tab (Figure 3, Item 4) 90 degree ensuring the loop opening is facing to the inside of the pack tray (Figure 3, Item 5).



Figure 3. Routing Main Closing Loop.

REPLACE – CONTINUED

CAUTION

Do not attempt to tack through stiffener. Failure to heed caution will result in damage to the stiffener.

3. Using two 12-inch lengths of one turn double, lacing and tying tape, tack both sides of the main closing loop protective cover (Figure 4). Secure with a surgeon's knot locking knot to the inside of the pack tray. Trim the ends to within ½ inch.

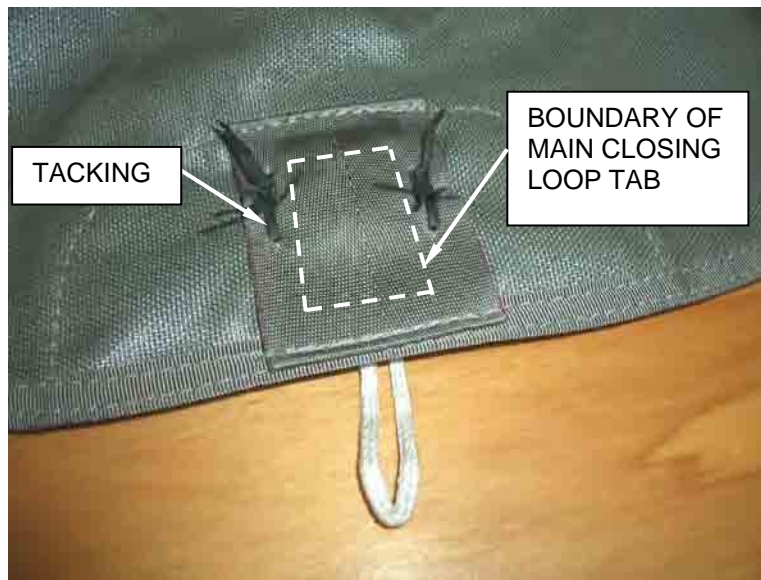

Figure 4. Tacking Both Sides of the Protective Cover.

END OF TASK

REPLACE - CONTINUED**Attaching the Harness Assembly to New Pack Tray**

1. Attach the harness assembly to the pack tray as follows:
 - a. Lay pack tray (Figure 5, Item 1) on pack table with the harness assembly attaching points (Figure 5, Item 2) facing up.
 - b. Place the new harness assembly (Figure 5, Item 3) on the pack tray (Figure 5, Item 1) with the hip (Figure 5, Item 4) and shoulder pads (Figure 5, Item 5) facing up. Ensure the diagonal back straps intersect (Figure 5, Item 6) in the center of the pack tray, and ensure there are no twists in the upper main lift web (Figure 5, Item 7), and lower saddle assembly (Figure 5, Item 8).

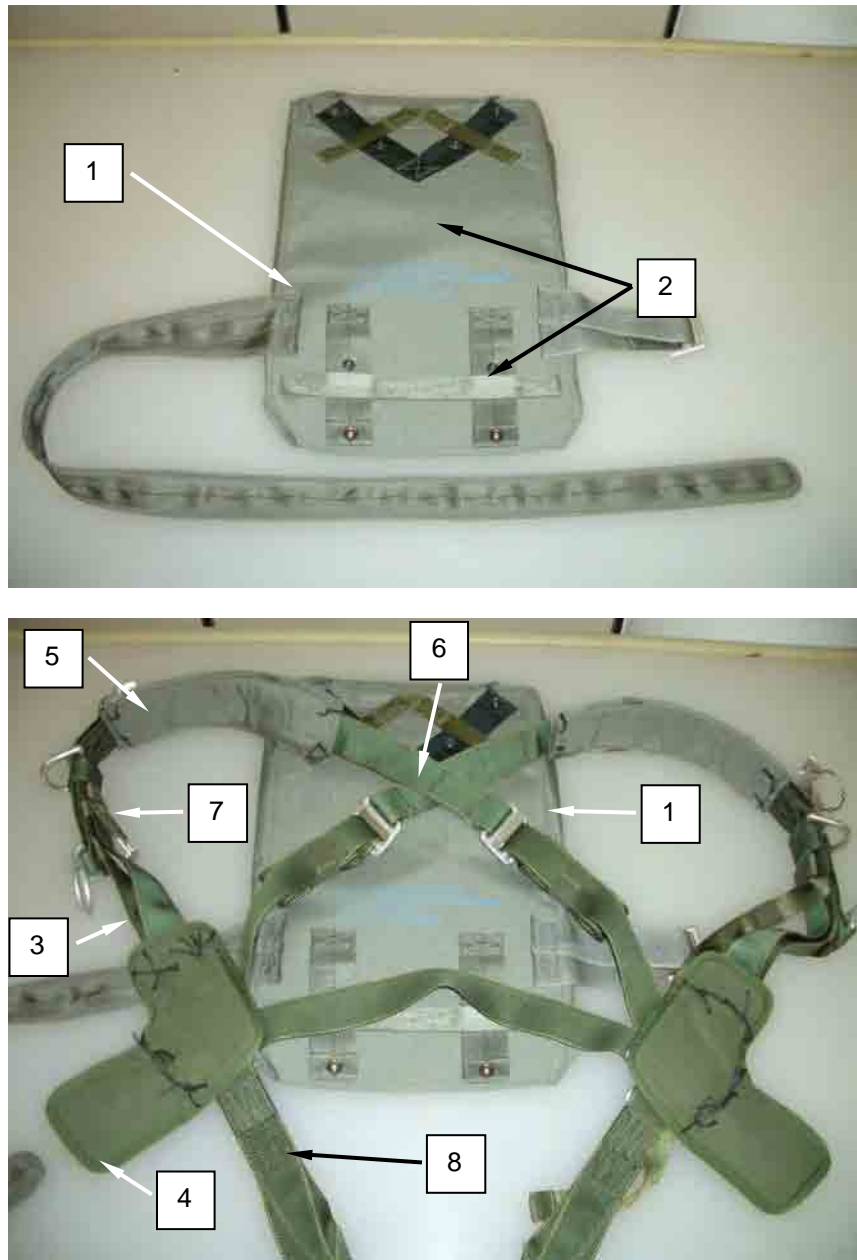

Figure 5. Pack Tray and Harness Assembly.

REPLACE – CONTINUED

2. Secure the horizontal back strap (Figure 6, Item 1) by routing both pack tray horizontal back strap retainers (Figure 6, Item 2) over the horizontal back strap (Figure 6, Item 1), and under the horizontal back strap keepers and secure the snap fasteners (Figure 6, Item 3).

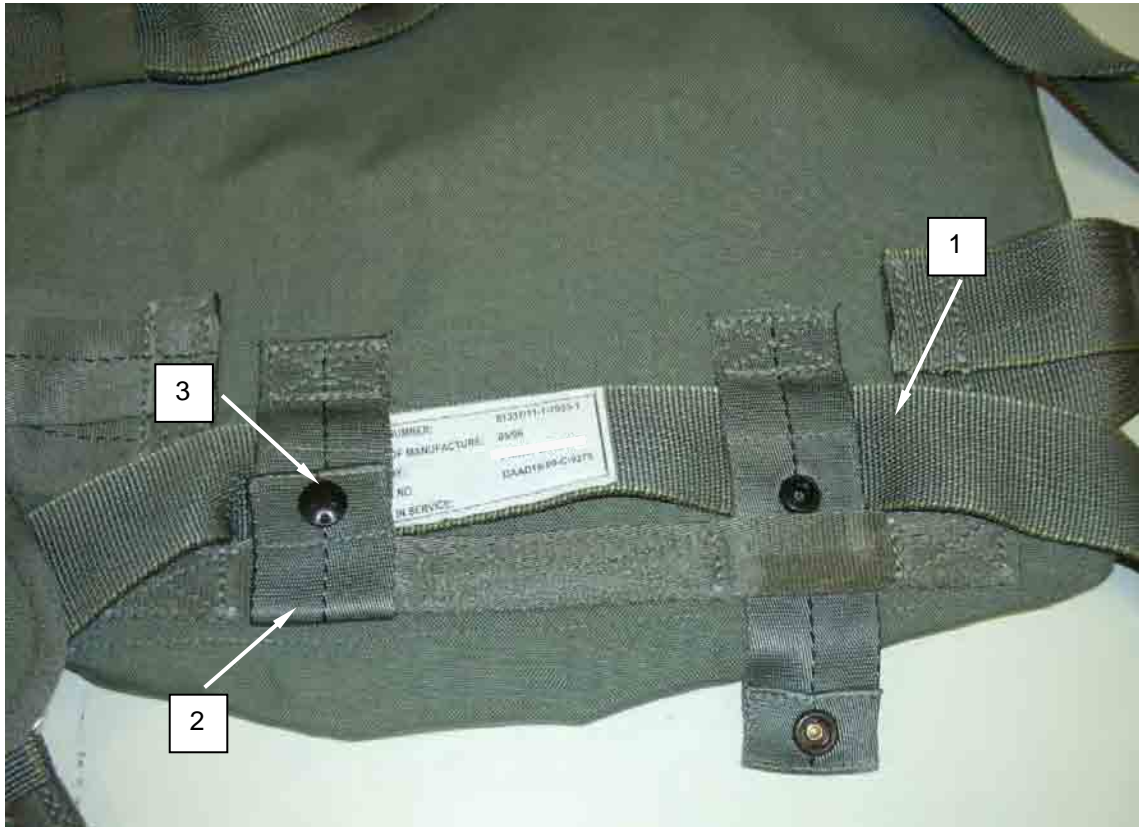

Figure 6. Securing Horizontal Back Strap.

REPLACE – CONTINUED

3. Attach diagonal back straps (Figure 7, Item 1) by routing the diagonal backstrap retainer (Figure 7, Item 2) through the selected sizing channel (Figure 7, Item 3).
4. Route the diagonal backstrap retainer (Figure 7, Item 2) through the diagonal backstrap keeper (Figure 7, Item 4).
5. Close snap fastener (Figure 7, Item 5) to secure.
6. Repeat for the opposite side (Figure 7, Item 6), ensure that the same sizing channel is used for both sides.

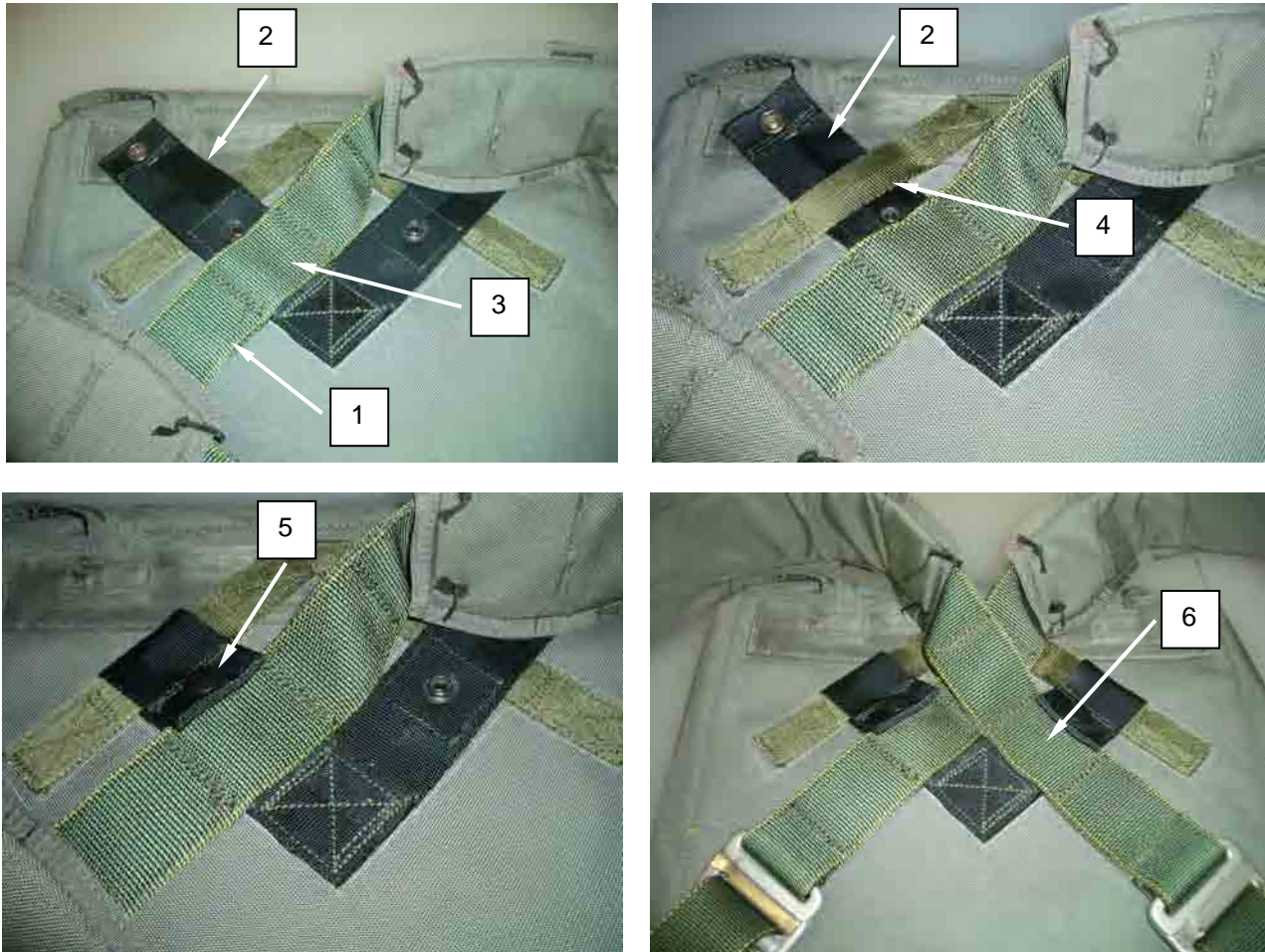

Figure 7. Route Tuck Tabs, Close Snap Fastener, and Snap Fastener Secured.

END OF TASK

REPLACE – CONTINUED**Attach Retainer Bands to Pack Tray Assembly**

Attach two large retainer bands (Figure 8, Item 1) on each outer static line stow bar (Figure 8, Item 2) and one large retainer band on each inner static line stow bar. Attach two small retainer bands to the static line slack retainer (Figure 8, Item 3) of the pack tray (Figure 8, Item 4).

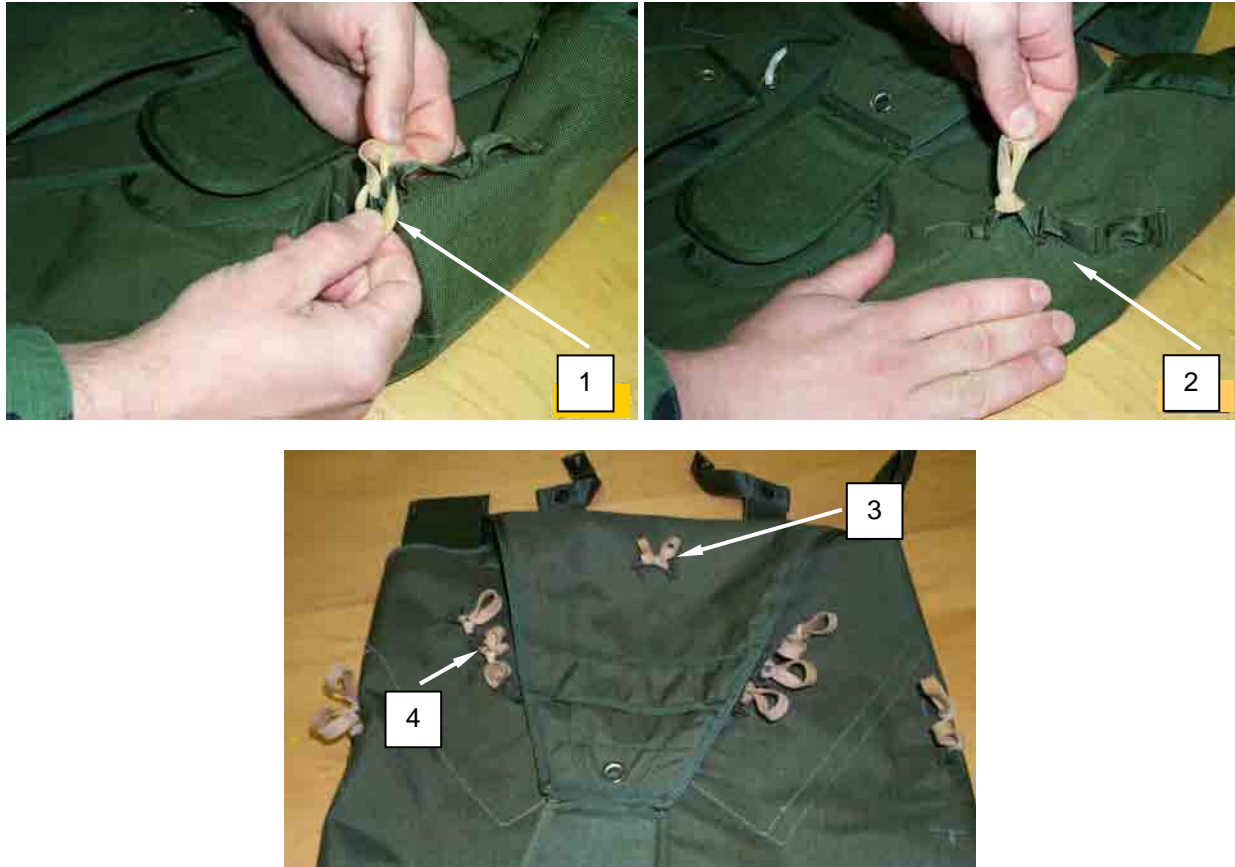

Figure 8. Attaching Retainer Bands to Static Line Stow Bars and Static Line Slack Retainer.

END OF TASK

END OF WORK PACKAGE

FIELD MAINTENANCE**MAIN PACK TRAY LARGE FABRIC LOOP
REPLACE**

INITIAL SETUP:**Tools and Special Tools**

Knife, Pocket (WP 0102, Item 25)
Needle, Upholsterer's Curved, Size 5 (WP 0102,
Item 32)

Personnel Required

Parachute Rigger 92R1P (1)

Materials/Parts

Tape, Lacing and Tying, Nylon, A-A-52080-B-3
(WP 0101, Item 41)

Equipment Condition

Unpacked

REPLACE**Replace Main Closing Loop (Large Fabric Loop) on Main Pack Tray**

1. Lay out on packing table or other suitable area.
2. Remove the damaged main closing loop; cut the lacing and tying tape, securing the main closing loop protective cover.
3. Remove the main closing loop from the pack tray.
4. Replace damaged main closing loop with a new main closing loop, no exceptions.

REPLACE – CONTINUED

5. Route the main closing loop (Figure 1, Item 1) under the main closing loop protective cover (Figure 1, Item 2) and through the grommet (Figure 1, Item 3).
6. Rotate the main closing loop tab (Figure 1, Item 4) 90 degrees ensuring the loop opening is facing to the inside of the pack tray (Figure 1, Item 5).



Figure 1. Routing Main Closing Loop.

REPLACE-CONTINUED

CAUTION

Do not attempt to tack through stiffener. Failure to heed caution will result in damage to the stiffener.

- Using two, 12-inch lengths of one turn double, lacing and tying tape, tack both sides of the main closing loop protective cover (Figure 2). Secure with a surgeon's knot locking knot to the inside of the pack tray. Trim the ends to within $\frac{1}{2}$ inch.

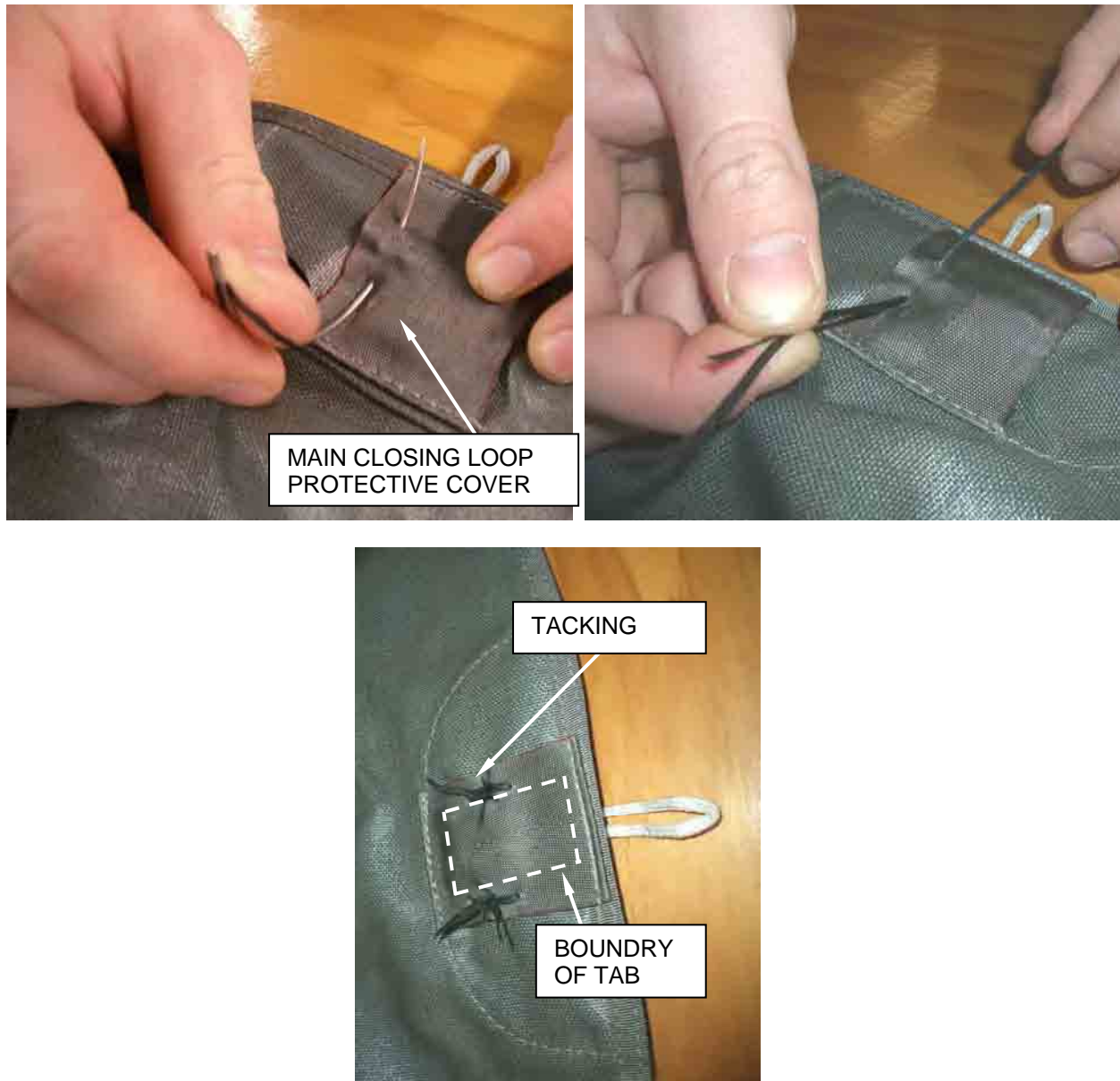
**END OF TASK****END OF WORK PACKAGE**

FIELD MAINTENANCE

MAIN PACK TRAY CLOSING PIN COVER
REPLACE

INITIAL SETUP:

Tools and Special Tools

Mallet, Rawhide (WP 0102, Item 29)
Pliers, Diagonal Cutting (WP 0102, Item 38)
Punch and Die, Grommet Inserting, Size 0,
Spur (WP 0102, Item 43)
Punch, Cutting, Double Bow (WP 0102,
Item 44)
Sewing Machine, Medium Duty (WP 0102,
Item 59)
Shears, Tailors, 12 inch (WP 0102, Item 61)
Stitch Removal Tool (WP 0102, Item 64)

Personnel Required

Parachute Rigger 92R1P (1)

Equipment Condition

Unpacked

MATERIALS/PARTS

Grommet, Rolled Rim/Spur Washer, 305
Stainless Steel, No. 0L (WP 0101, Item 25)
Thread, Nylon, V-T-295, Type I or II, Class A,
Size E, FG504 (WP 0101, Item 54)

REPLACE

1. Lay out on packing table or other suitable area.
2. Using a stitch removal tool, carefully remove the damaged pin protector cover (Figure 1, Item 1).
3. Remove any loose stitching.



Figure 1. Remove Damaged Pin Protector Cover.

REPLACE – CONTINUED

4. Insert barrel of replacement grommet (Figure 2, Item 2) through accommodating hole in the material (Figure 2, Item 1) and ensure grommet flange (Figure 2, Item 3) is located on the same side of the material as original grommet.

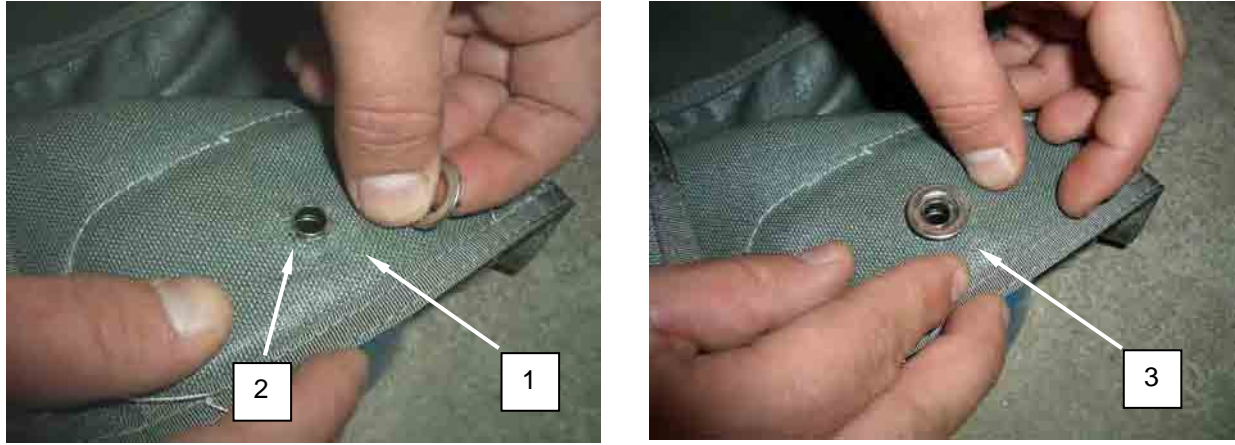

Figure 2. Insert Barrel of Replacement Grommet through Accommodating Hole.

5. Position grommet on the die (Figure 3, Item 1) with the barrel facing up and place washer over grommet barrel. Ensure grommet barrel and washer are aligned to prevent off-center setting of grommet.



Figure 3. Position Grommet on the Die.

6. Using a punch (Figure 4, Item 1) and rawhide mallet or other non-steel impact device, spread grommet barrel by hammering until barrel collar is rolled down smooth on washer.
7. If grommet barrel splits during hammering, remove and replace installed grommet with a serviceable item from stock. Remove the damaged grommet and repeat the entire procedure.
8. Ensure grommet components are tight against material and do not spin.

REPLACE – CONTINUED

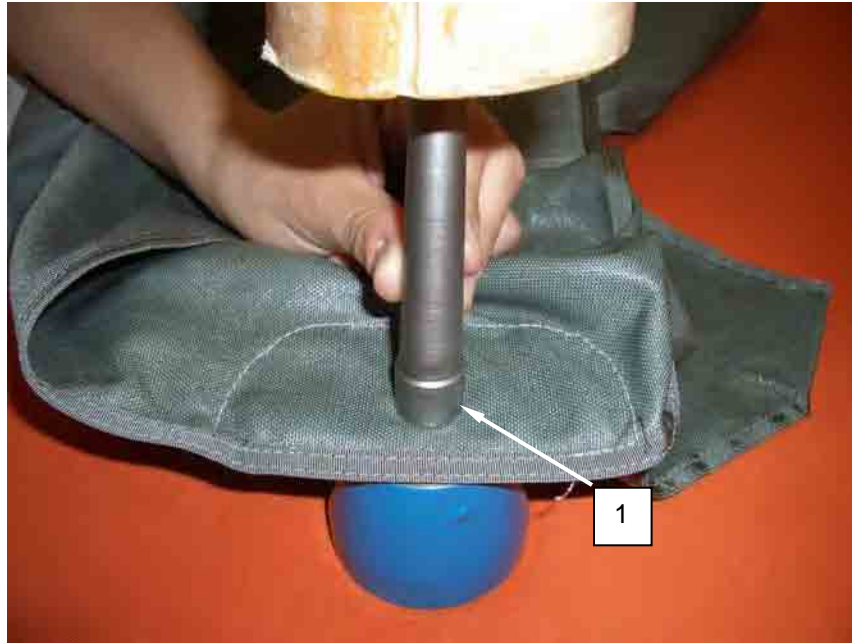

Figure 4. Spread Grommet Barrel.

9. Center the new pin protector cover (Figure 5, Item 1) overlapping the binding tape (Figure 5, Item 2) at the end of the inside edge of top flap. Fold the running end of the binding tape (Figure 5, Item 3) between top cover and pin protection cover.



Figure 5. Replace Damaged Pin Protector Flap.

REPLACE – CONTINUED

10. Using a medium duty sewing machine and size E nylon thread, 7 to 11 stitches per inch and centered between two rows of existing stitching. Complete three passes of stitching from edge to edge. Sew the pin protector cover (Figure 6, Item 1) to the binding tape.

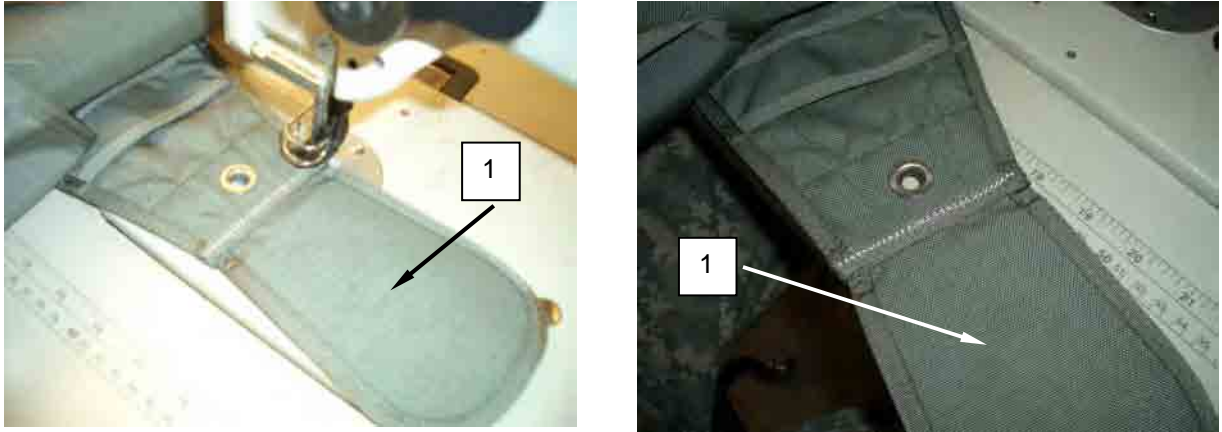

Figure 6. Sew Pin Protector Cover to Binding Tape.

END OF TASK

END OF WORK PACKAGE

FIELD MAINTENANCE

**MAIN PACK TRAY STIFFENER METALLIC GROMMETS
REPAIR, REPLACE**

INITIAL SETUP:**Tools and Special Tools**

Mallet, Rawhide (WP 0102, Item 29)
 Pliers, Diagonal Cutting (WP 0102, Item 38)
 Punch and Die, Grommet Inserting, Size 0,
 Spur (WP 0102, Item 43)
 Punch, Cutting, Double Bow (WP 0102,
 Item 44)
 Sewing Machine, Medium Duty (WP 0102,
 Item 59)
 Shears, Tailors, 12 inch (WP 0102, Item 61)
 Stitch Removal Tool (WP 0102, Item 64)

Personnel Required

Parachute Rigger 92R1P (1)

References

WP 0043

Equipment Condition

Unpacked

Materials/Parts

Cloth, Abrasive (WP 0101, Item 10)
 Grommet, Rolled Rim/Spur Washer, 305
 Stainless Steel, No. 0L (WP 0101, Item 25)
 Thread, Nylon, V-T-295, Type I or II, Class A,
 Size E, FG504 (WP 0101, Item 54)
 Webbing, Nylon, MIL-W-4088, Type XII, 1-inch
 Wide, FG504 (WP 0101, Item 61)

REPAIR**Repair Grommets**

Remove burrs, rough spots, rust, or corrosion from an installed grommet by buffing with crocus cloth.

Reseat a loose grommet as follows:

1. Insert barrel of replacement grommet (Figure 1, Item 1) through accommodating hole in the material and ensure grommet flange is located on the same side of the material as original grommet.



Figure 1. Insert Barrel of Replacement Grommet through Accommodating Hole.

REPAIR – CONTINUED

2. Position grommet on the die (Figure 2, Item 1) with the barrel facing up and place washer over grommet barrel. Ensure grommet barrel and washer are aligned to prevent off-center setting of grommet.



Figure 2. Position Grommet on the Die.

3. Using a punch (Figure 3, Item 1) and rawhide mallet or other non-steel impact device, spread grommet barrel by hammering until barrel collar is rolled down smooth on washer.
4. If grommet barrel splits during hammering, remove and replace installed grommet with a serviceable item from stock. Remove the damaged grommet and repeat the entire procedure.
5. Ensure grommet components are tight against material and do not spin.

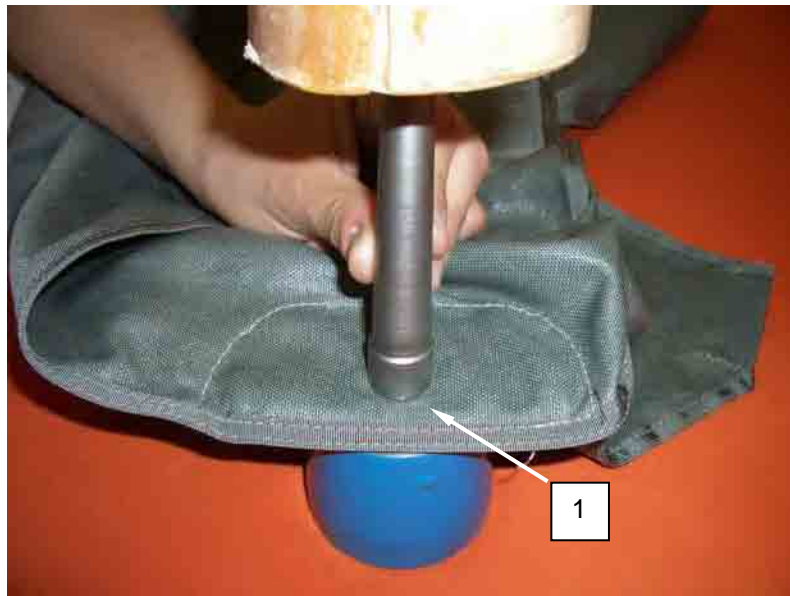

Figure 3. Spread Grommet Barrel.

END OF TASK

REPLACE

Replace Grommet and Stiffener

Refer to WP 0043 to replace a damaged main pack tray side stiffener grommet.

END OF TASK

END OF WORK PACKAGE

FIELD MAINTENANCE

**MAIN PACK TRAY SNAP FASTENER
REPAIR, REPLACE**

INITIAL SETUP:**Tools and Special Tools**

Chuck, Socket (WP 0102, Item 8)
 Die Tool, Fastener (WP 0102, Item 13)
 Die, Eyelet (WP 0102, Item 14)
 Heated Blade Cutter (WP 0102, Item 18)
 Holder, Die Fastener (WP 0102, Item 20)
 Key Set, Socket Head Screw (WP 0102,
 Item 23)
 Mallet, Rawhide (WP 0102, Item 29)
 Pliers, Diagonal Cutting (WP 0102, Item 38)
 Shears, Tailors, 12 inch (WP 0102, Item 61)

Personnel Required

Parachute Rigger 92R1P (1)

Materials/Parts

Cap, Snap Fastener Style 4, 24 Line
 (WP 0101, Item 8)
 Eyelet, Metallic, Style 4 (WP 0101, Item 21)
 Socket, Snap Fastener, Style 4 (WP 0101,
 Item 36)
 Stud, Snap Fastener, Style 4 (WP 0101,
 Item 39)
 Thread, Nylon, V-T-295, Type I or II, Class A,
 Size E, FG504 (WP 0101, Item 54)
 Webbing, Nylon, MIL-W-4088, Type II, 1 inch
 Wide, FG504 (WP 0101, Item 59)

Equipment Condition

Unpacked

REPAIR

Snap fastener repair is limited to reseating, which will be accomplished using the applicable procedures and tools prescribed in the replace procedures detailed below.

END OF TASK**REPLACE****NOTE**

Directional snap fasteners will only be found on the horizontal strap back fastener.

A snap fastener that is unserviceable or cannot be reseated will be replaced with a serviceable item from stock. However, if only one part of a fastener is unserviceable, such as the socket or stud, just that particular portion of the fastener assembly requires replacement. Replace a damaged snap fastener as follows:

REPLACE – CONTINUED**WARNING**

Ensure that eye protection is worn. Serious injury can result from flying metal pieces coming in contact with eyes if proper safety precautions are not observed.

Remove Original Snap Fastener

1. Remove original snap fastener by one of the following methods:
 - a. Cut crimped edge of applicable snap fastener assembly part at three or four points with diagonal cutters.
 - b. Using a suitable type tool, pry back fastener crimped edges and remove unserviceable fastener parts.

Installing New Snap Fastener

If fabric area around original snap fastener is damaged, repair the area by applying a reinforcement patch to the outside of the material. Use a 1-inch square of seared type II nylon webbing.

Hand-held Method.

1. Place selected chuck (Figure 1, Item 1) in open end of holder (Figure 1, Item 2) and secure chuck in place using locking screw (Figure 1, Item 3) located on one side of holder (Figure 1, Item 2). Then place the die (Figure 1, Item 4) into anvil (Figure 1, Item 5).

NOTE

Snap fasteners located on the harness assembly are not authorized for replacement.

2. Fit socket or stud (Figure 1, Item 6), as applicable, on chuck (Figure 1, Item 1) lower end. Place cap or post, as applicable, on die (Figure 1, Item 4) with barrel facing up.
3. Position material over barrel of cap or post. Ensure that fastener socket or stud (Figure 1, Item 7) is located on proper side of material for subsequent fastener engagement.
4. Place socket or stud on barrel of cap or post. With a mallet, strike holder, clinching the two snap fastener components to material.
5. Remove clinched snap fastener components from chuck (Figure 1, Item 1) and die set (Figure 1, Item 4) and check seating of joined components. If applicable components are not properly seated, repeat procedures in step 4 above.
6. Check engagement of installed snap fastener components with opposite mating components to ensure open and closed snapping process without hindrance. If snap engaging process cannot be accomplished without difficulty, replace opposite mating snap fastener components using procedures in steps 1 through 5 above. As required, remove chuck and die from applicable snap fastener tools by reversing procedures in step 1 above.

REPLACE - CONTINUED

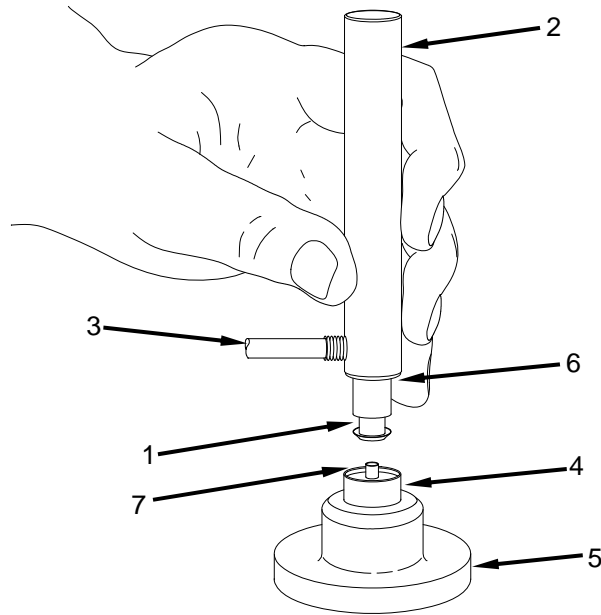

Figure 1. Hand-held Method.

Hand or Foot-Press Method. Installation of a snap fastener assembly by hand or foot operated press (Figure 2, Item 1) may be accomplished using the procedures in step 1 above, except one uses the hand or foot to press the two pieces together, and the chuck (Figure 2, Item 2) and die (Figure 2, Item 3) will be secured within the applicable press assembly using the available locking screws (Figure 2, Item 4).

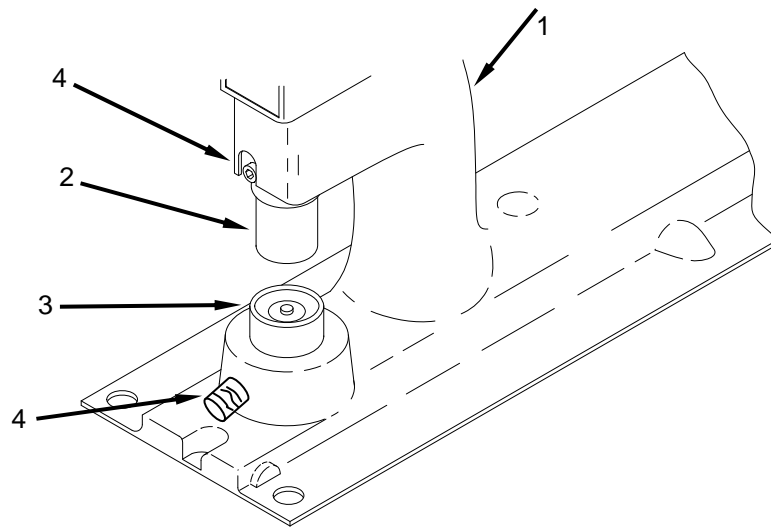

Figure 2. Hand or Foot Operated Press Method.

END OF TASK

END OF WORK PACKAGE

FIELD MAINTENANCE**MAIN SIDE STIFFENERS
REPAIR, REPLACE**

INITIAL SETUP:**Tools and Special Tools**

Mallet, Rawhide (WP 0102, Item 29)
Pliers, Diagonal Cut (WP 0102, Item 38)
Punch and Die, Grommet Inserting, Size 0,
(WP 0102, Item 43)
Punch, Cutting, Double Bow
(WP 0102, Item 44)
Sewing Machine, Medium Duty
(WP 0102, Item 59)
Shears, Tailors, 12 inch (WP 0102, Item 61)
Stitch Removal Tool (WP 0102, Item 64)

Personnel Required

Parachute Rigger 92R1P (1)

Materials/Parts

Cloth, Abrasive (WP 0101, Item 10)
Grommet, Rolled Rim/Spur Washer, 305
Stainless Steel, No. 0L (WP 0101, Item 25)
Thread, Nylon, V-T-295, Type I or II, Class A,
Size E, FG504 (WP 0101, Item 54)
Webbing, Nylon, MIL-W-4088, Type XII, 1 inch
Wide, FG504 (WP 0101, Item 61)

REPAIR**Repair Grommets**

1. Remove burrs, sharp edges, rough spots, rust, or corrosion from an installed grommet by buffing with abrasive cloth.
2. Reseat a loose grommet using steps 4 through 8 of the replace procedure.

END OF TASK

REPLACE**Replace Stiffener and Grommet****NOTE**

If stiffener needs to be replaced, the grommet must also be replaced.

1. Remove original grommet as follows:

WARNING

Ensure that eye protection is worn. Serious injury can result from flying metal pieces coming in contact with eyes if proper safety precautions are not observed.

- a. Using the diagonal pliers, lift edge of original washer at one point.
- b. Grip lift washer edge (Figure 1, Item 1) with diagonal pliers and roll washer edge back to lift washer from original grommet. Remove original grommet from material.
- c. If fabric area around the original grommet has been damaged, repair area by applying a reinforcement patch to the outside of flap. Use a 1-inch square of seared type XII nylon webbing.



Figure 1. Remove Original Grommet.

2. Remove the stitching bordering the stiffener on the inside surface of the pack tray (Figure 2). Remove the stiffener.

REPLACE - CONTINUED



Figure 2. Remove Stitching Bordering the Stiffener.

3. Insert a new stiffener (Figure 3, Item 1). Using a medium duty sewing machine and size E nylon thread, 7 to 11 stitches per inch, close the open side of the type II nylon webbing locking the stitching along the binding tape.



Figure 3. Insert a New Stiffener.

4. Insert barrel (Figure 4, Item 1) of replacement grommet through accommodating hole in the material and ensure grommet flange (Figure 4, Item 2) is located on the same side of the material as original grommet.

REPLACE - CONTINUED

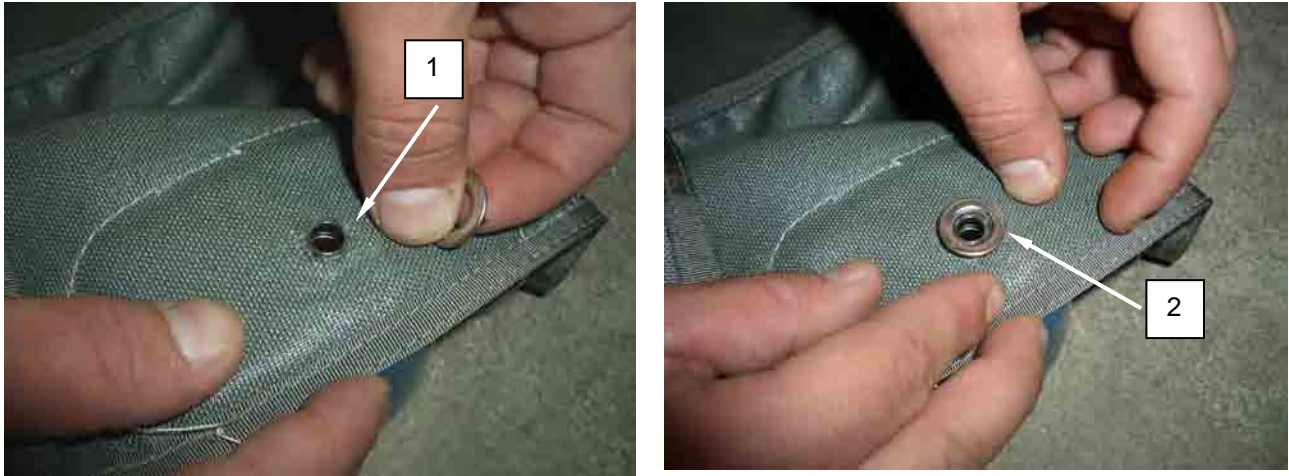

Figure 4. Insert Barrel of Replacement Grommet.

5. Position grommet (Figure 5, Item 1) on the die (Figure 5, Item 2) with the barrel facing up and place washer over grommet barrel. Ensure grommet barrel and washer are aligned to prevent off-center setting of grommet.



Figure 5. Position Grommet on Die with Barrel Facing Up and Place Washer over Grommet Barrel.

REPLACE - CONTINUED

6. Using a punch and rawhide mallet or other non-steel impact device (Figure 6, Item 1), spread grommet barrel by hammering until barrel collar is rolled down smooth on washer.

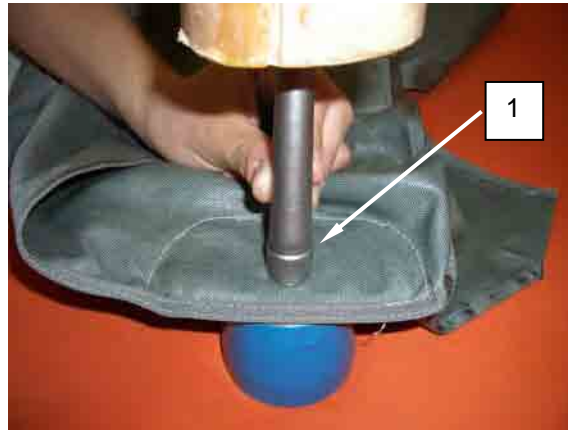

Figure 6. Spread Grommet Barrel.

7. If grommet barrel splits during hammering, remove and replace installed grommet with a serviceable item from stock. Remove the damaged grommet and repeat the entire procedure.
8. Ensure grommet components are tight against material and do not spin.

END OF TASK

END OF WORK PACKAGE

FIELD MAINTENANCE**MAIN PACK TRAY TOP/BOTTOM STIFFENERS
REPAIR, REPLACE**

INITIAL SETUP:**Tools and Special Tools**

Mallet, Rawhide (WP 0102, Item 29)
Pliers, Diagonal Cutting (WP 0102, Item 38)
Punch and Die, Grommet Inserting, Size 0
(WP 0102, Item 43)
Punch, Cutting, Double Bow (WP 0102,
Item 44)
Sewing Machine, Medium Duty (WP 0102,
Item 59)
Shears, Tailors, 12 inch (WP 0102, Item 61)
Stitch Removal Tool (WP 0102, Item 64)

Personnel Required

Parachute Rigger 92R1P (1)

Materials/Parts

Grommet, Rolled Rim/Spur Washer, 305
Stainless Steel, No. 0 (WP 0101, Item 25)
Thread, Nylon, V-T-295, Type I or II, Class A,
Size E, FG504 (WP 0101, Item 54)
Webbing, Nylon, MIL-W-4088, Type XII, 1-inch
Wide, FG504 (WP 0101, Item 61)

REPAIR**Repair Grommets**

1. Remove burrs, sharp edges, rough spots, rust, or corrosion from an installed grommet by buffing with abrasive cloth.
2. Reseat a loose grommet using Steps 4 through 8 of the replace procedure.

END OF TASK

REPLACE**Replace Stiffener and Grommet****NOTE**

If stiffener needs to be replaced the grommet must also be replaced.

1. Remove original grommet as follows:

WARNING

Ensure that eye protection is worn. Serious injury can result from flying metal pieces coming in contact with eyes if proper safety precautions are not observed.

- a. Using the diagonal pliers, lift edge of original washer at one point.
- b. Grip lifted washer edge (Figure 1, Item 1) with diagonal pliers and roll washer edge back to lift washer from original grommet. Remove original grommet from material.
- c. If fabric area around the original grommet has been damaged, repair area by applying a reinforcement patch to the outside of flap. Use a 1-inch square of seared type II nylon webbing.



Figure 1. Remove Original Grommet.

REPLACE - CONTINUED

2. Remove the stitching bordering the stiffener on the inside surface of the pack tray. Remove the stiffener (Figure 2, Item 1).

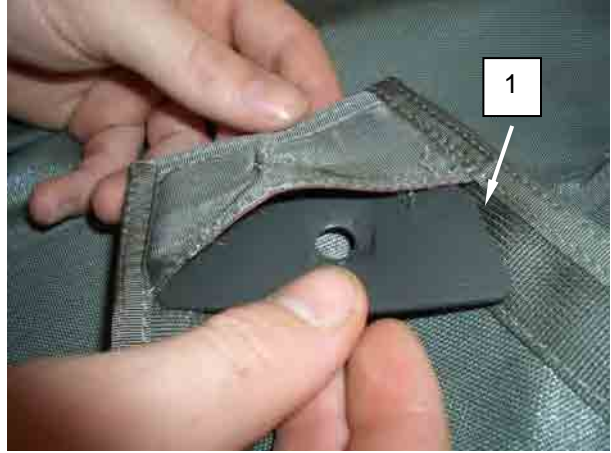

Figure 2. Remove Stiffener.

3. Insert a new stiffener (Figure 3, Item 1). Using a medium duty sewing machine and size E nylon thread, 7 to 11 stitches per inch, close the open side of the type XII nylon webbing locking the stitching along the binding tape.



Figure 3. Insert New Stiffener.

REPLACE - CONTINUED

4. Insert barrel of replacement grommet (Figure 4, Item 1) through accommodating hole in the material and ensure grommet flange is located on the same side of the material as original grommet.

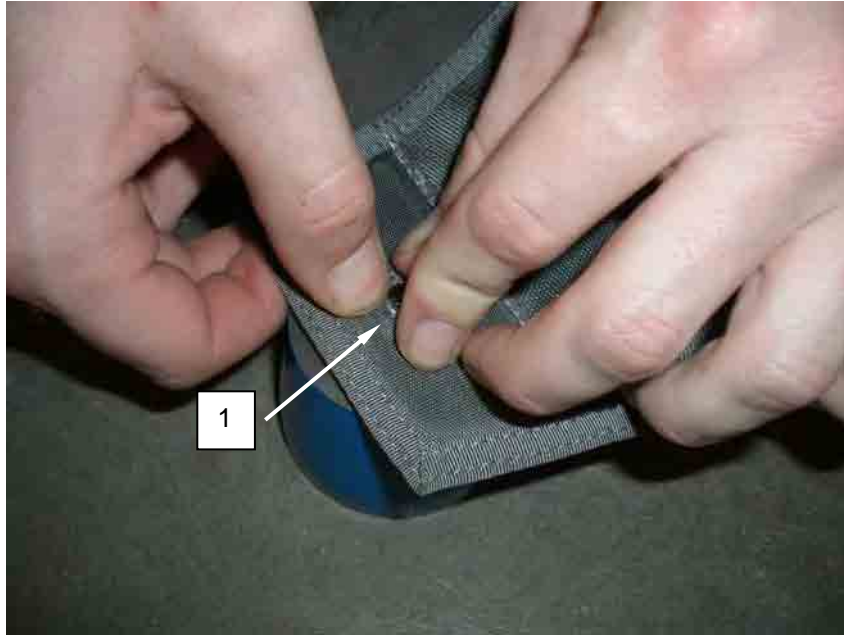

Figure 4. Insert Barrel of Replacement Grommet through Accommodating Hole in Material.

5. Position grommet (Figure 5, Item 1) on the die (Figure 5, Item 2) with the barrel facing up and place washer over grommet barrel. Ensure grommet barrel and washer are aligned to prevent off-center setting of grommet.

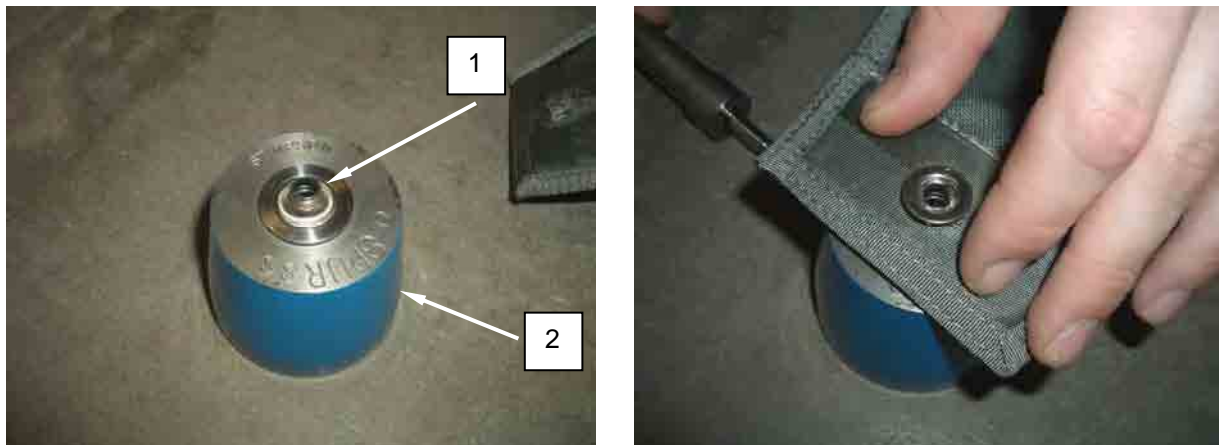

Figure 5. Position Grommet on Die with Barrel Facing up and Place Washer over Grommet Barrel.

REPLACE - CONTINUED

6. Using a punch and rawhide mallet or other non-steel impact device, spread grommet barrel by hammering until barrel collar is rolled down smooth on washer (Figure 6).



Figure 6. Spread Grommet Barrel.

7. If grommet barrel splits during hammering, remove and replace installed grommet with a serviceable item from stock. Remove the damaged grommet and repeat the entire procedure.
8. Ensure grommet components are tight against material and do not spin.

END OF TASK

END OF WORK PACKAGE

FIELD MAINTENANCE

DIAGONAL BACK STRAP RETAINER
REPLACE

INITIAL SETUP:

Tools and Special Tools

Sewing Machine, Medium Duty
(WP 0102, Item 59)
Stitch Removal Tool (WP 0102, Item 64)

Personnel Required

Parachute Rigger 92R1P (1)

Equipment Condition

Materials/Parts

Thread, Nylon, V-T-295, Type I or II, Class A,
Size E, FG504 (WP 0101, Item 54)

Unpacked

REPLACE

Replace Diagonal Back Strap Retainer

1. Lay out on packing table or other suitable area.
2. Remove damaged diagonal back strap retainer (Figure 1, Item 1) by removing stitching with stitch removal tool.
3. Obtain a new diagonal back strap retainer from stock and place in position with snap fasteners (Figure 1, Item 2) facing up and lower end of retainer overlapping lower end of back strap retainer on opposite side.
4. Using a medium duty sewing machine, size E nylon thread, 7 to 11 stitches per inch, sew in place with a double Box-X pattern.

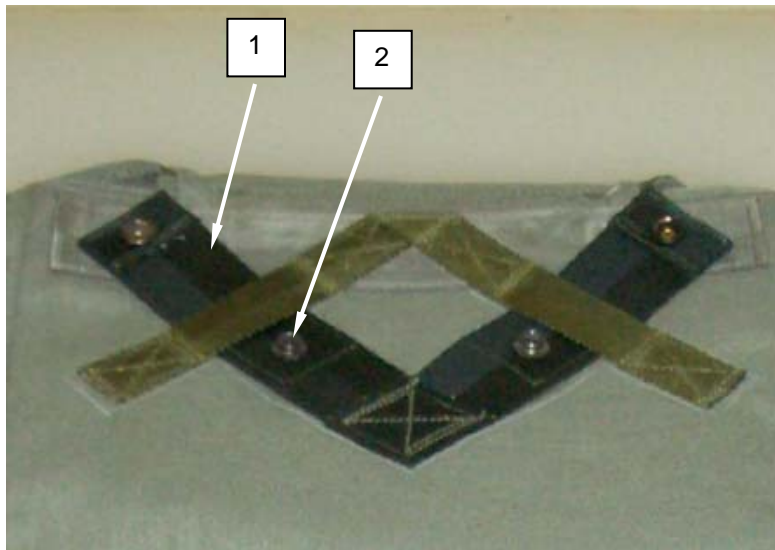

Figure 1. Replacing Diagonal Back Strap Retainer.

END OF TASK

END OF WORK PACKAGE

0045-1/2 blank

FIELD MAINTENANCE**HORIZONTAL BACK STRAP RETAINER
REPAIR, REPLACE**

INITIAL SETUP:**Tools and Special Tools**

Heated Blade Cutter (WP 0102, Item 18)
Sewing Machine, Medium Duty (WP 0102,
Item 59)
Shears, Tailors, 12-inch (WP 0102, Item 61)
Stitch Removal Tool (WP 0102, Item 64)

Personnel Required

Parachute Rigger 92R1P (1)

References

WP 0042

Materials/Parts

Pencil, China Marker, Yellow, A-A-87
(WP 0101, Item 30)
Thread, Nylon, V-T-295, Type I or II, Class A,
Size E, FG504 (WP 0101, Item 54)

Equipment Condition

Lay out on packing table or other suitable area.

REPAIR**CAUTION**

If the horizontal back strap retainer has been completely ripped off during a parachute operation, the main pack tray shall be removed from service.

Re-stitch the horizontal back strap retainer using a medium duty sewing machine with size E nylon thread 7 to 11 stitches per inch.

Refer to WP 0042 if repairing a snap directional fastener.

END OF TASK**REPLACE**

1. Trace the outside edges of the horizontal back strap using a marking device. This will be used as a guide during installation of the new horizontal back strap retainer.
2. Remove stitching securing the damaged horizontal back strap retainer to the main pack tray, ensuring all loose stitching is removed.
3. Discard damaged back strap retainer and obtain a serviceable item from stock.
4. Position the new horizontal back strap retainer onto the pack tray by aligning with the marks placed onto the pack tray in step 1.

REPLACE - CONTINUED**NOTE**

A glue gun is authorized to secure the new horizontal back strap retainer to the main pack tray.

Ensure snap fasteners are not closed during this step.

5. Route the horizontal back strap retainer under the horizontal back strap keeper ensuring that the snap fastener closes back over the horizontal back strap keeper.
6. After the horizontal back strap retainer has been positioned, sew to main pack tray using medium duty sewing machine with size E nylon thread, 7 to 11 stitches per inch, making a box X stitching $\frac{3}{4}$ -inch X $1\frac{3}{8}$ -inch with double rows on the top and bottom.

END OF TASK**END OF WORK PACKAGE**

FIELD MAINTENANCE

T-11 HARNESS ASSEMBLY
REPLACE

INITIAL SETUP:

Materials/Parts

Marker, Felt Tip, Black, Permanent (WP 0106, Item 28)
Pen, Ball Point (WP 0106, Item 29)

Personnel Required

Parachute Rigger 92R1P (1)

Equipment Condition

Lay out on packing table or other suitable area.

References

WP 0018

REPLACE

NOTE

If harness assembly is not attached to the pack tray, start with procedure entitled "Attaching the New Harness Assembly to Tray Pack."

Remove Unserviceable Harness Assembly from Main Pack Tray**NOTE**

If necessary, remove main risers from pack tray assembly.

1. Layout the pack tray (Figure 1, Item 1) and harness assembly (Figure 1, Item 2) on the pack table with the harness assembly facing up.
2. Remove the harness assembly (Figure 1, Item 2) from the pack tray (Figure 1, Item 1) by unsnapping the diagonal back strap retainer (Figure 1, Item 3) and remove from behind the diagonal back strap keeper (Figure 1, Item 4).
3. Remove from the diagonal back strap sizing channels (Figure 1, Item 5) on both the left and right.

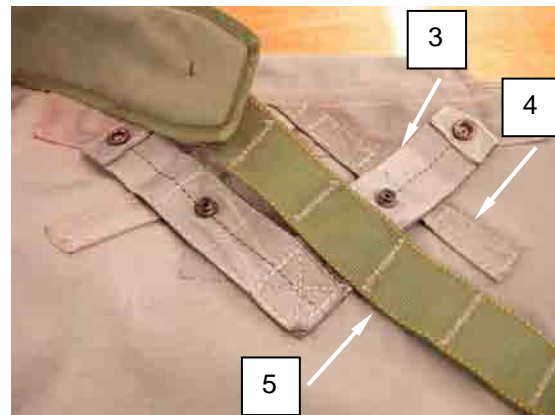

Figure 1. Remove Harness Assembly from Pack Tray.

REPLACE - CONTINUED

4. Remove the horizontal back strap (Figure 2, Item 1) from the pack tray (Figure 2, Item 2) by unsnapping the horizontal back strap retainer snap fasteners (Figure 2, Item 3).
5. Remove the horizontal back strap retainers (Figure 2, Item 4) from behind the horizontal back strap keeper (Figure 2, Item 5).
6. Remove harness assembly (Figure 2, Item 6).

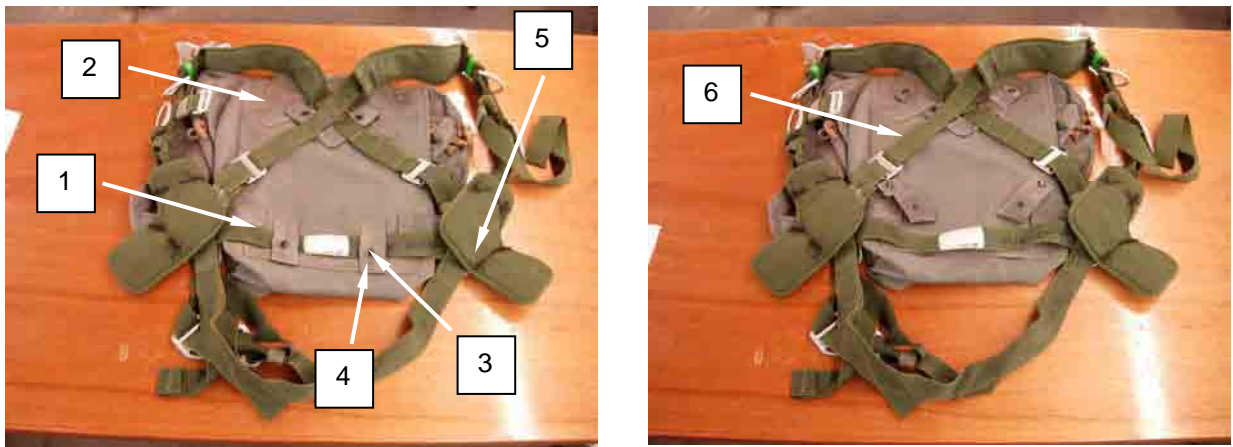

Figure 2. Removing Unserviceable Pack Tray.

END OF TASK

REPLACE - CONTINUED**Attaching the New Harness Assembly to Main Pack Tray**

1. Lay pack tray (Figure 3, Item 1) on pack table with the harness attaching points (Figure 3, Item 2) facing up.

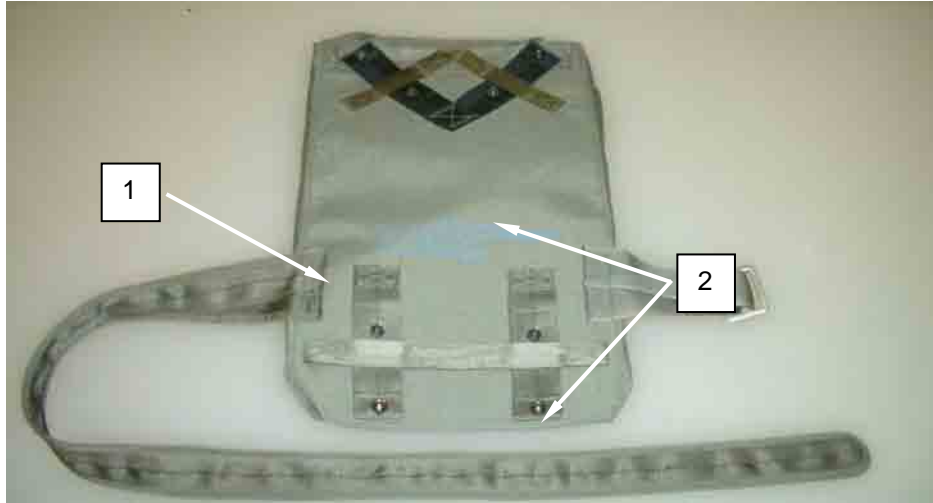

Figure 3. Main Pack Tray.

2. Place the new harness assembly (Figure 4, Item 1) assembly on the pack tray (Figure 3, Item 1) with the hip (Figure 4, Item 2) and shoulder pads (Figure 4, Item 3) facing up. Ensure the diagonal back straps intersect (Figure 4, Item 4) in the center of the pack tray, and ensure there are no twists in the upper main lift web (Figure 4, Item 5), and lower saddle assembly (Figure 4, Item 6).

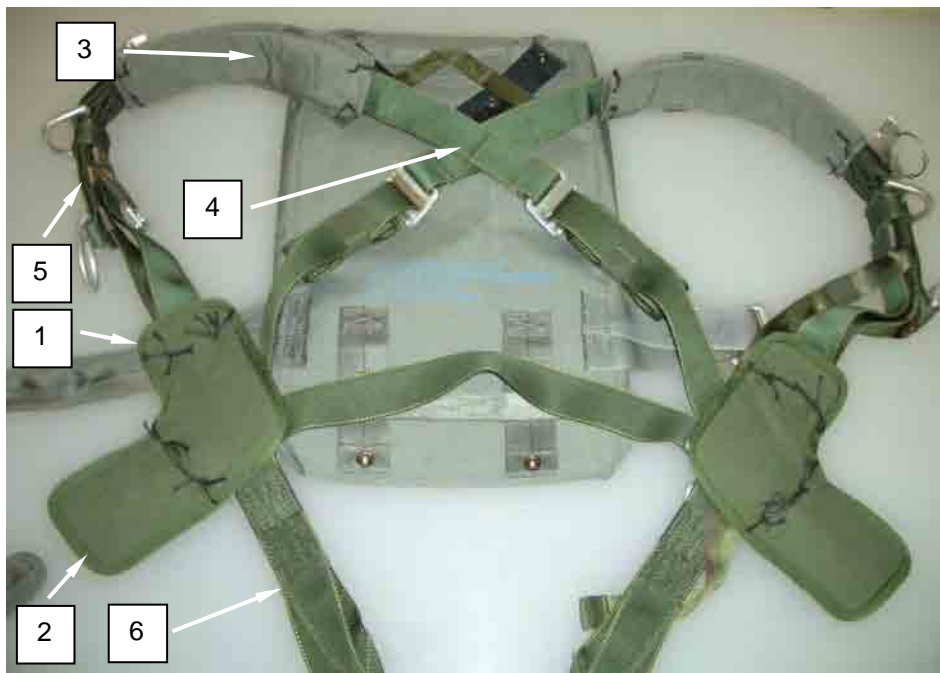

Figure 4. Pack Tray and Harness Assembly.

REPLACE – CONTINUED

3. Secure the horizontal back strap (Figure 5, Item 1) by routing both pack tray horizontal back strap retainers (Figure 5, Item 2) over the horizontal back strap (Figure 5, Item 1), and under the horizontal back strap keepers and secure the directional snap fasteners (Figure 5, Item 3).

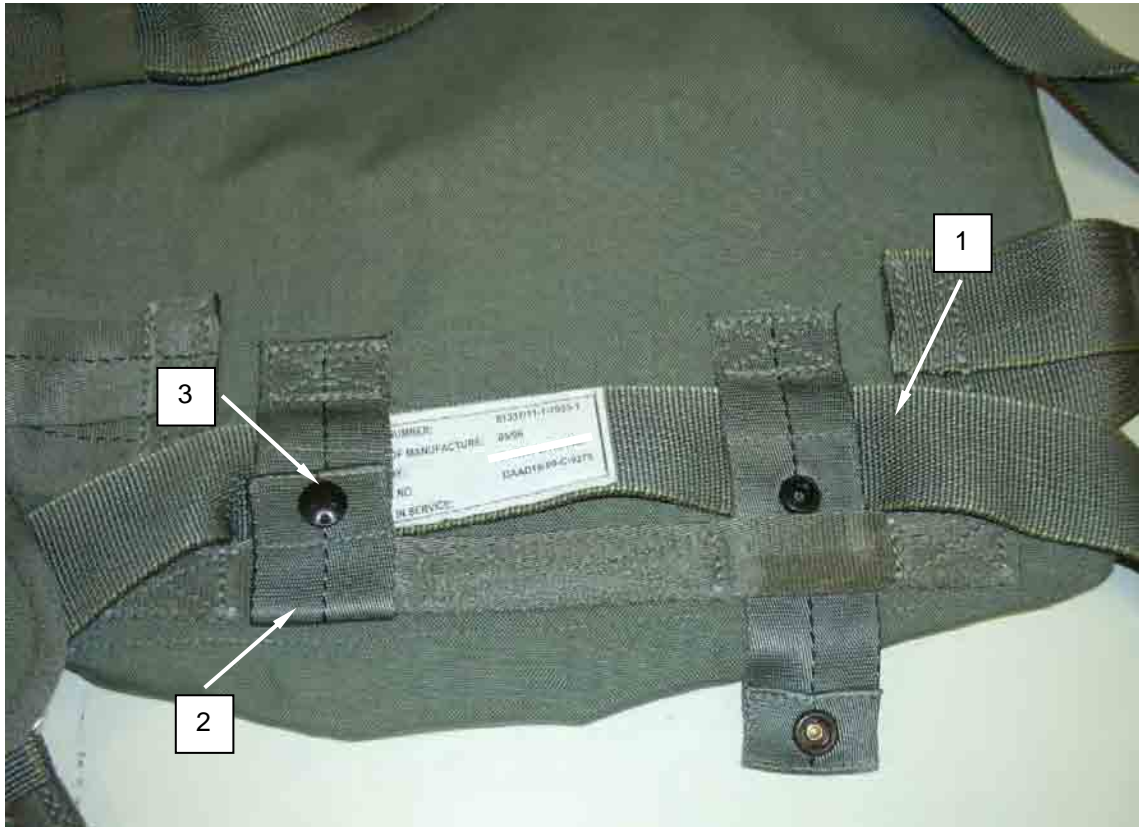

Figure 5. Securing Horizontal Back Strap.

REPLACE – CONTINUED

4. Attach diagonal back straps (Figure 6, Item 1) by routing the diagonal backstrap retainer (Figure 6, Item 2) through the selected sizing channel (Figure 6, Item 3).
5. Route the diagonal backstrap retainer (Figure 6, Item 2) through the diagonal backstrap keeper (Figure 6, Item 4).
6. Close directional snap fastener (Figure 6, Item 5) to secure.
7. Repeat for the opposite side (Figure 6, Item 6); ensure that the same sizing channel is used for both sides.

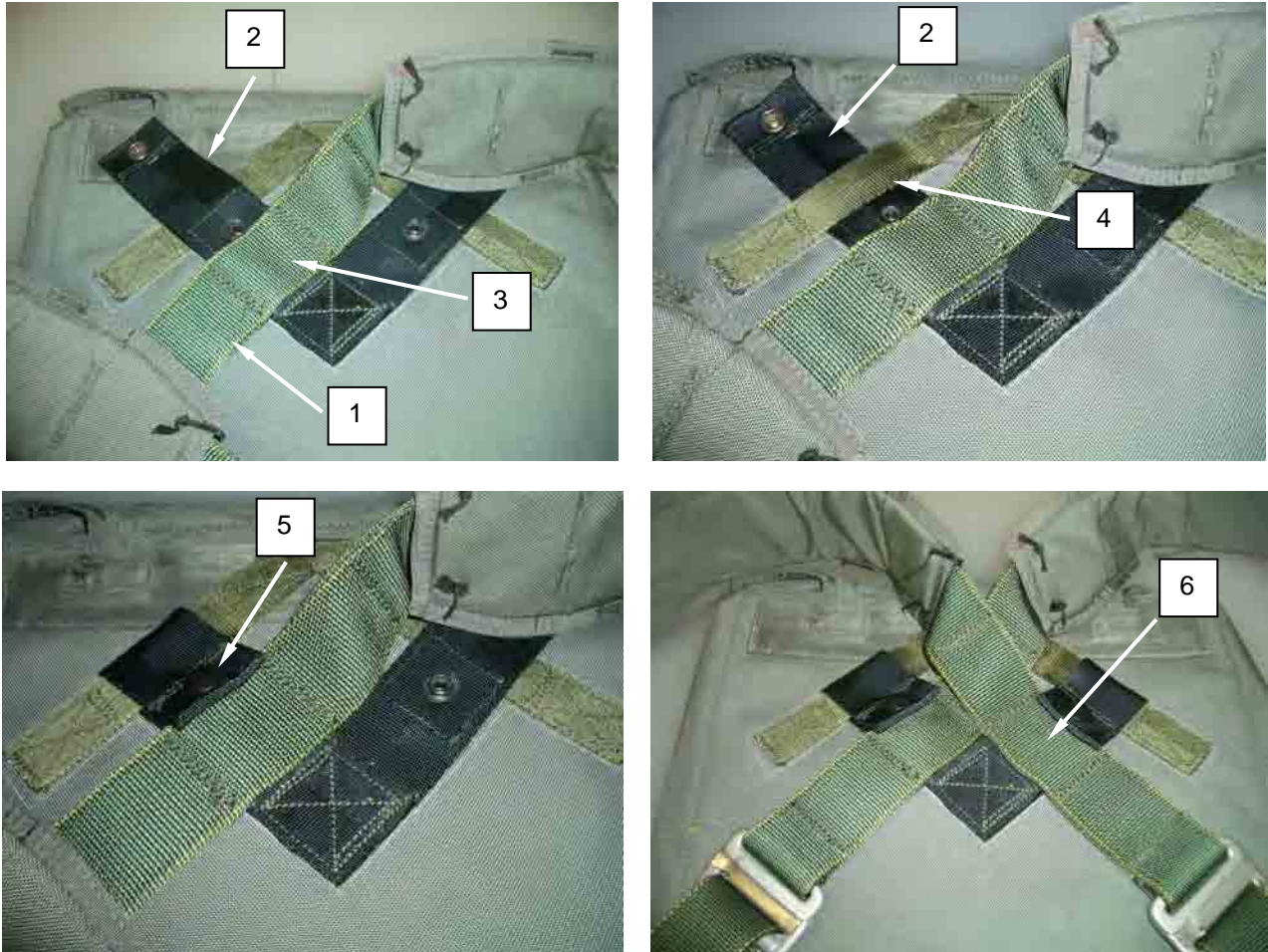

Figure 6. Route Diagonal Back Strap Keeper.

REPLACE – CONTINUED

8. Enter the placed in service date on the data label on the horizontal back strap (Figure 7, Item 1) IAW WP 0018.



Figure 7. Enter the Date in Service on Horizontal Back Strap in Data Label.

END OF TASK

END OF WORK PACKAGE

FIELD MAINTENANCE**T-11 HIP PAD ASSEMBLY
REPAIR, REPLACE**

INITIAL SETUP:**Tools and Special Tools**

Needle, Upholsterers, Curved, Size 5 (WP 0102, Item 32)
 Sewing Machine, Light Duty (WP 0102, Item 57)
 Shears, Tailors, 12 inch (WP 0102, Item 61)
 Stitch Removal Tool (WP 0102, Item 64)

Personnel Required

Parachute Rigger 92R1P (1)

References

WP 0016

Materials/Parts

Tape, Lacing And Tying, Nylon, A-A-502080-B-3 (WP 0101, Item 41)
 Thread, Nylon, V-T-295, Type I or II, Size E, FG504 (WP 0101, Item 54)

Equipment Condition

Lay out on packing table or other suitable area.

REPAIR**Re-stitching**

1. Re-stitch the L-shaped ejector snap pad directly over the original stitch pattern, as closely as possible, using a light-duty sewing machine, size E nylon thread that contrasts the color of the original stitching and material when possible, and 7 to 11 stitches per inches.
2. Lock each row of stitching with a 2-inch backstitch.

END OF TASK

REPLACE

1. Using a stitch removal tool, remove the lacing and tying tape (Figure 1, Item 1) that secures the damaged L-shaped ejector snap pad (Figure 1, Item 2) to the harness assembly (Figure 1, Item 3).



Figure 1. Removing Damaged L-Shaped Ejector Snap Pad.

2. Remove L-shaped ejector snap pad (Figure 1, Item 2) from harness assembly (Figure 1, Item 3).

REPLACE - CONTINUED

3. Ensure the ejector snap (Figure 1, Item 1) is facing down. Place new L-shaped ejector snap pad (Figure 1, Item 2) so that the L-shaped is facing outward.
4. Tack the L-shaped ejector snap pad (Figure 1, Item 2) to the harness assembly (Figure 1, Item 3) using a one turn double of lacing and tying tape (Figure 1, item 4).
5. Route the lacing and tying tape down through the L-shaped ejector snap pad and through the adjustment buckle to the outside of the main lift web strap and back up through the L-shaped ejector snap pad.

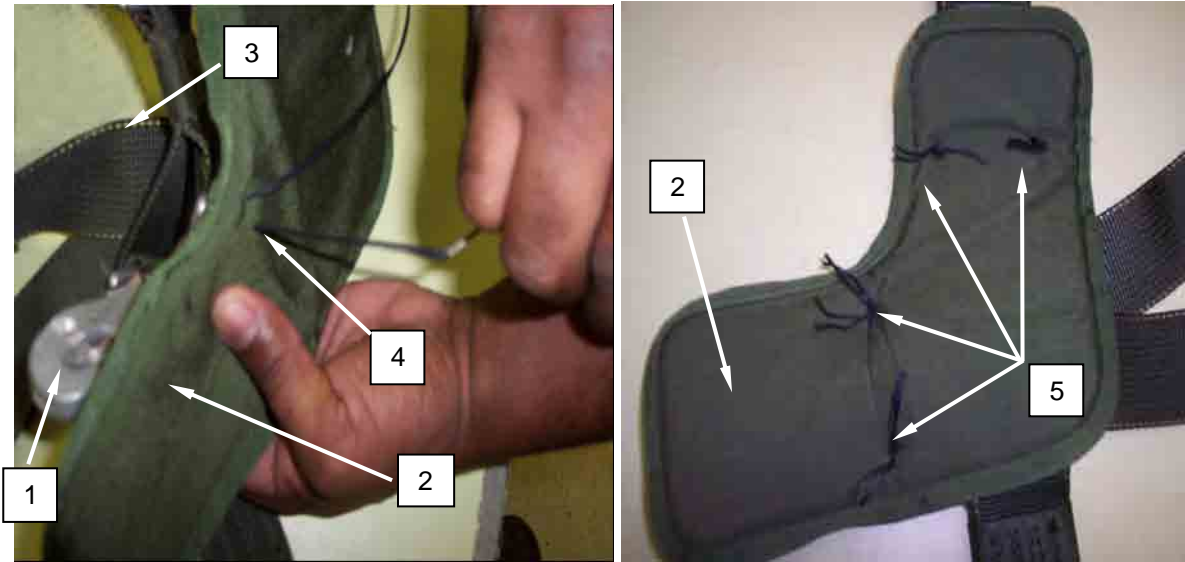

Figure 2. Tacking New L-Shaped Ejector Snap Pad.

6. Repeat this procedure for the second tie.
7. Tie the ends off using a surgeon's knot locking knot.
8. Route the lacing tape down through the L-shaped ejector snap pad and through the ejector snap buckle to the outside of the strap and back up through the L-shaped ejector snap pad.
9. Repeat this procedure for the second tie.
10. Tie the ends off using a surgeon's knot locking knot.
11. The L-shaped ejector snap pad must be tacked in four locations (Figure 1, Item 5) — two ties each on the adjustment buckle and ejector snap.

END OF TASK

END OF WORK PACKAGE

FIELD MAINTENANCE
**T-11 SADDLE ASSEMBLY
 RIGHT AND LEFT UPPER HARNESS
 T-11 DIAGONAL ASSEMBLY
 TUCK TAB ASSEMBLY
 REPAIR, REPLACE**

INITIAL SETUP:**Tools**

Gun, Glue (WP 0102, Item 17)
 Ruler, Tab, Metal, 16-inches (WP 0102, Item 46)
 Sewing Machine, Heavy Duty (WP 0102,
 Item 55)
 Sewing Machine, Medium Duty (WP 0102,
 Item 59)
 Shears, Tailors, 12 Inch (WP 0102, Item 61)
 Stitch Removal Tool (WP 0102, Item 64)

Personnel Required

Parachute Rigger 92R1P (1)

References

WP 0016
 WP 0047

Materials/Parts

Glue Stick (WP 0101, Item 24)
 Tape, Kevlar[®], 1-inch, Type IV, Natural (WP
 0101, Item 40)
 Thread, Nylon, Type I, II or III, Class A, Size 3,
 Color White (WP 0101, Item 51)
 Thread, Nylon, V-T-295, Type I, II, Class A, Size
 5, FG504 (WP 0101, Item 52)
 Thread, Nylon, V-T-295, Type I or II, Size E,
 FG504 (WP 0101, Item 54)
 Webbing, Nylon, MIL-W-4088, Type XII, 1 1/32 -
 inch wide, FG504 (WP 0101, Item 60)

Equipment Condition

Harness removed from main pack tray
 IAW WP 0047

REPAIR

Repair is limited to re-stitching or re-tacking in accordance with IAW WP 0016.

END OF TASK

REPLACE**NOTE**

Replace procedures in this section refer to both the left and right upper main lift web assemblies. Replace either side using these maintenance instructions.

1. Layout the harness assembly (Figure 1) ensuring that the L-shaped ejector snap pads (Figure 1, Item 1) and shoulder pads (Figure 1, Item 2) are facing up.



Figure 1. Proper Layout of Harness Assembly.

REPLACE**NOTE**

If replacing the lower saddle assembly, perform tasks below on both upper main lift web assemblies.

2. Carefully remove stitching of the rolled back end of the horizontal back straps (Figure 2, Item 1).



Figure 2. Remove Stitching From Diagonal Back Straps.

NOTE

Only remove horizontal back strap on the side being replaced.

3. Remove the horizontal back strap (Figure 2, Item 2) from the back strap adjuster (Figure 2, Item 3).

REPLACE-CONTINUED

4. Un-snap the tuck tab snap fastener (Figure 3, Item 1) on the tuck tab assembly (Figure 3 Item 2) of the upper main lift web (Figure 3, Item 3).

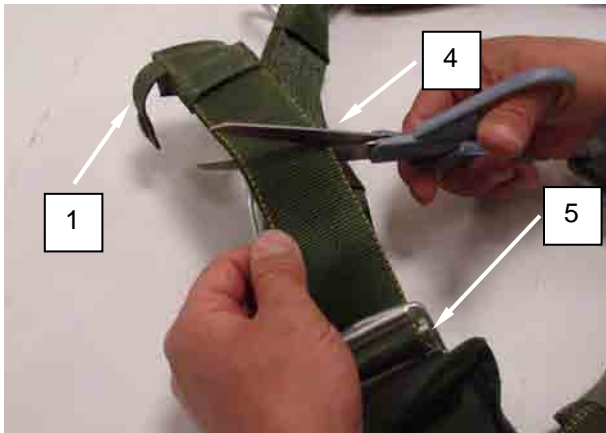
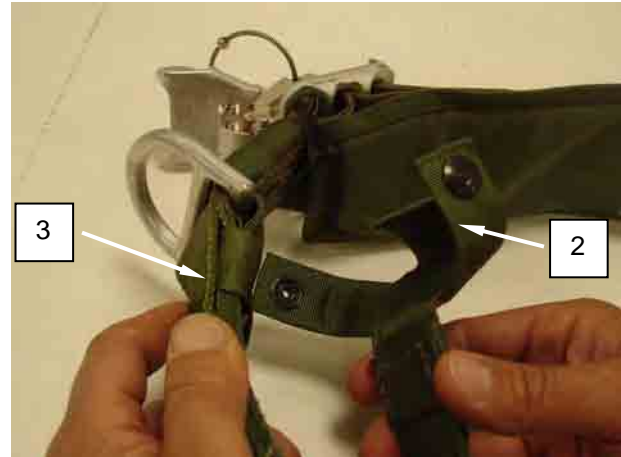
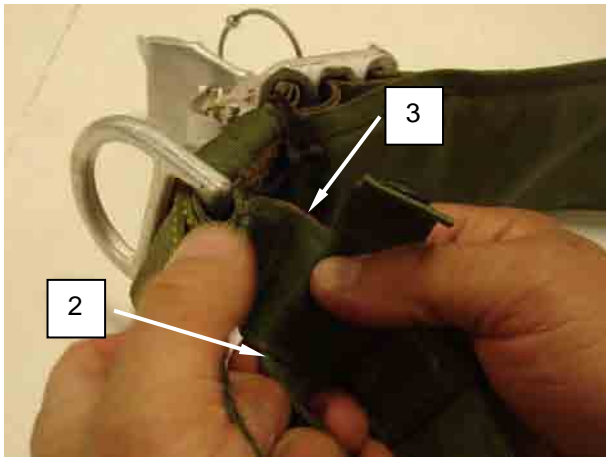
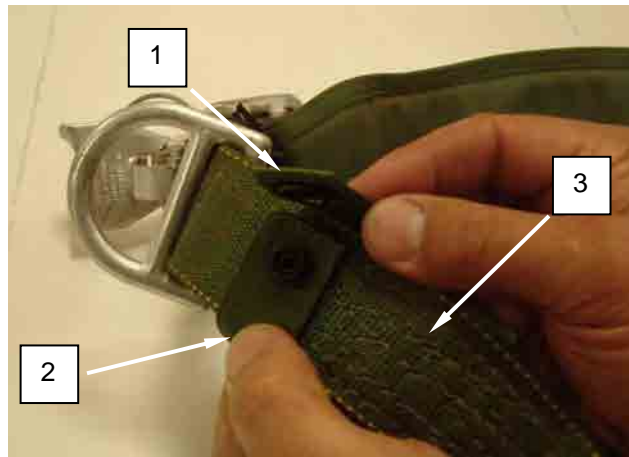

Figure 3. Replacing Harness Left Upper Main Lift Web Assemblies.

5. Using shears (Figure 3, Item 4) carefully cut the upper main lift web strap between the tuck tab snap fastener (Figure 3, Item 1) and the main lift web adjuster (Figure 3, Item 5)
6. Remove main lift web from the main lift web adjuster (Figure 3, Item 6). Discard the damaged part.

REPLACE-CONTINUED**NOTE**

Right upper main lift web assembly will contain the chest strap with attached friction adapter

Left upper main lift web assembly will contain the chest strap

7. Obtain a new or serviceable replacement item from stock (Figure 4).



Figure 4. Right and Left Upper Main Lift Web Assemblies.

REPLACE-CONTINUED

8. Lay out the saddle assembly (Figure 5) so that the L-shaped ejector snap pads are facing up and the ejector snaps are facing down. The right horizontal back strap (Figure 5, Item 1) will cross over the left horizontal back strap (Figure 5, Item 2) forming an X (Figure 5, Item 3).

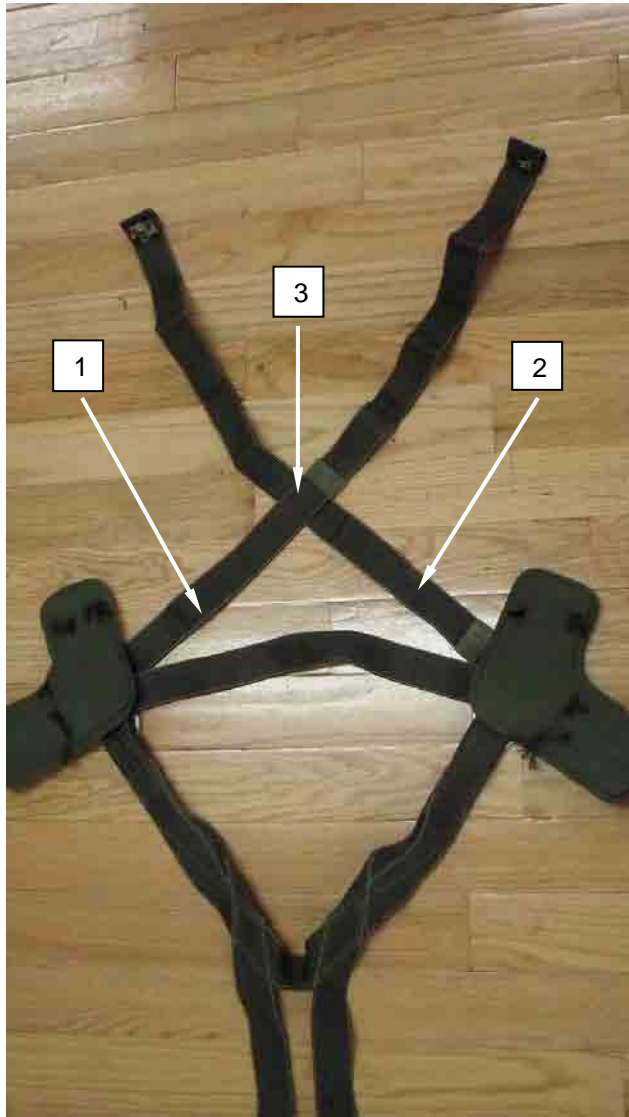

Figure 5. Saddle Assembly.

REPLACE-CONTINUED

9. Layout right upper main lift web assembly (Figure 6, Item 1) and left upper main lift web assembly (Figure 6, Item 2), so that the canopy release assemblies (CRA) are facing down. Equipment D-rings (Figure 6, Item 3) are located toward the saddle assembly (Figure 6, Item 4) and the shoulder pads (Figure 6, Item 5) are facing up.

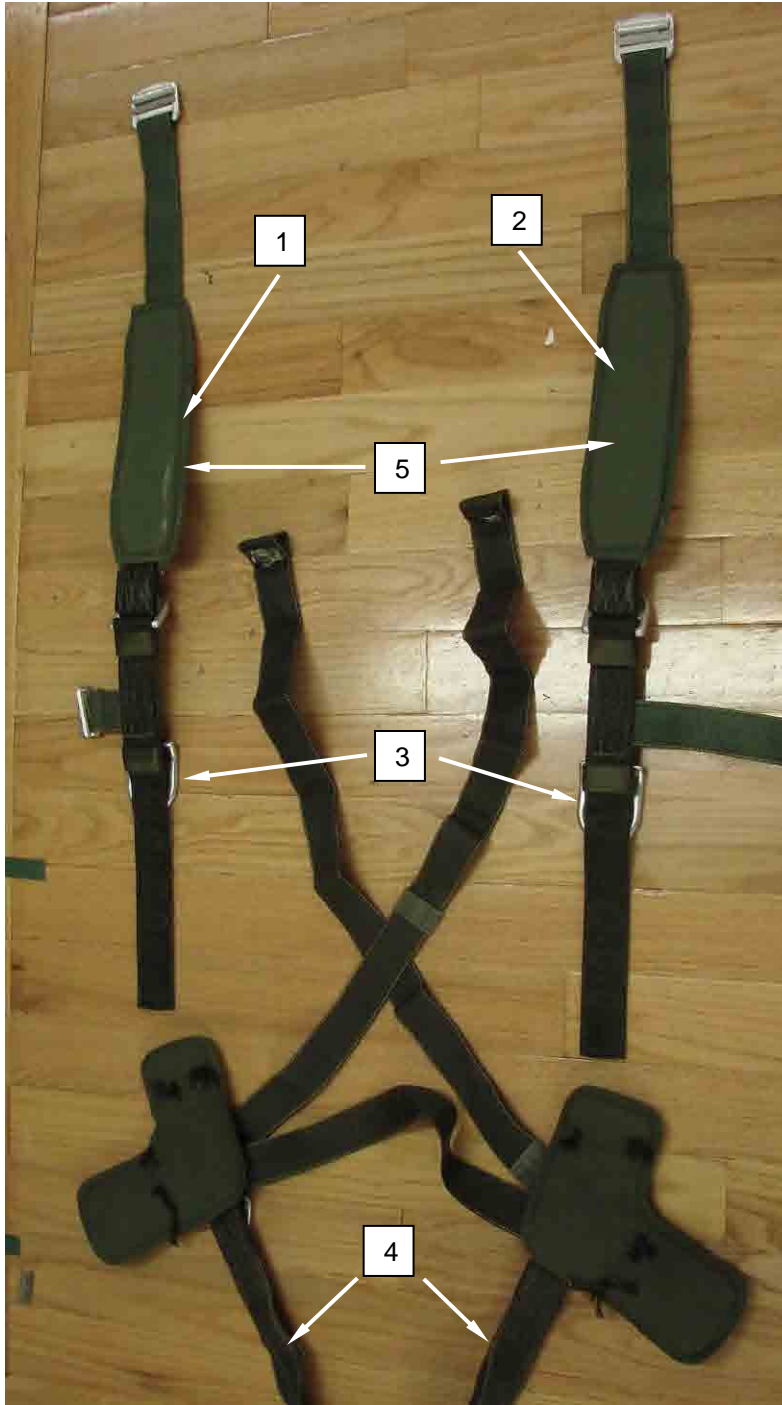

Figure 6. Layout of Harness Assembly Components.

REPLACE-CONTINUED

NOTE

Ensure that approximately 5 inches of excess webbing are pulled through the main lift web adjuster.

Ensure that there are no twists are put into the right and left upper main lift web straps during the installation process.

10. Thread both the right and left upper main lift web straps (Figure 7, Item 1) through the respective main lift web adjusters (Figure 7, Item 2) on the saddle assembly (Figure 7, Item 3).
11. Route the main webbing straps from back to front below the floating bar, then route from front to back above the floating bar of the main lift web adjuster.

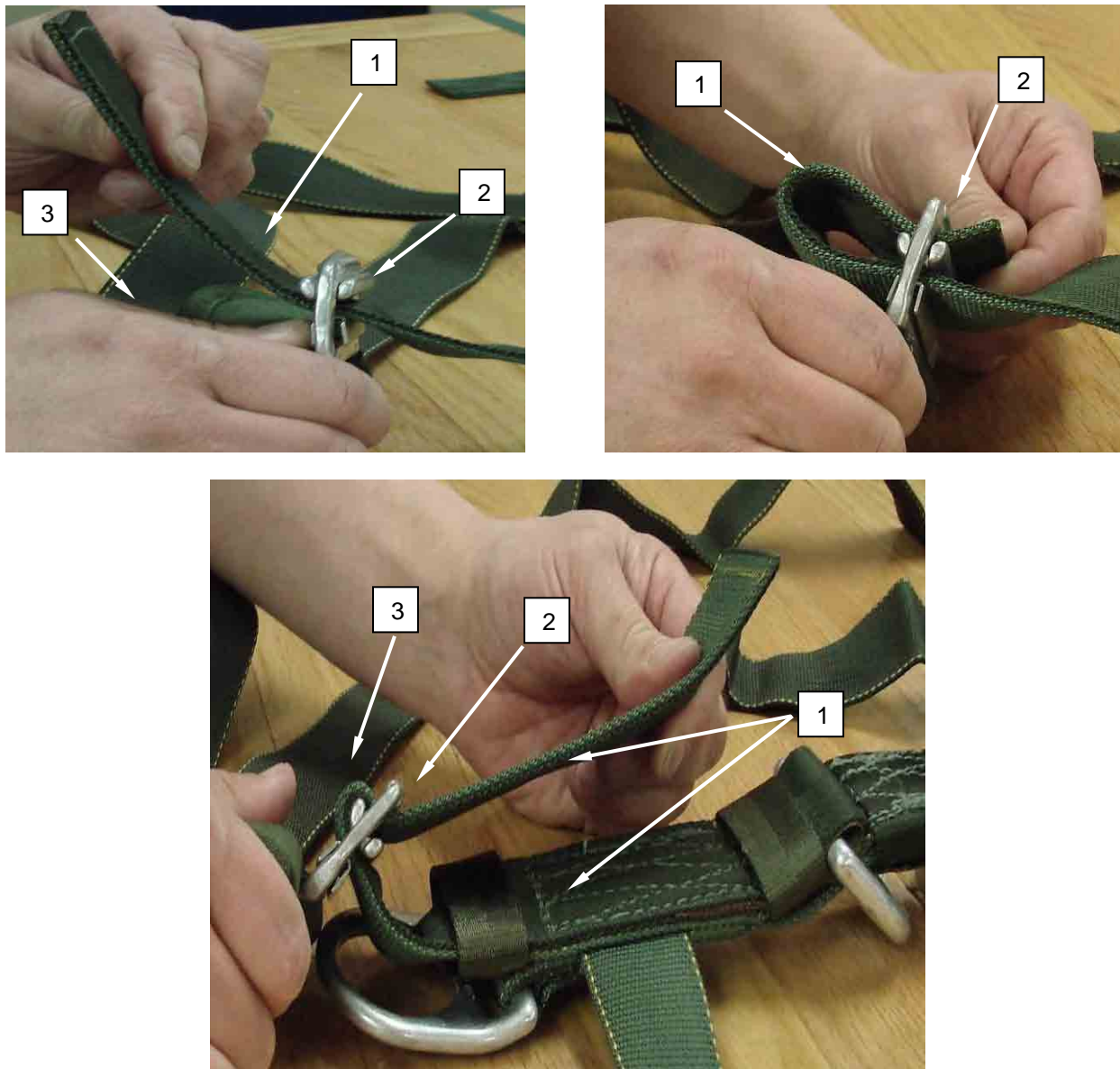

Figure 7. Routing of the Left Upper Main Lift Web Straps.

REPLACE-CONTINUED

12. Route the horizontal back straps (Figure 8, Item 1) through the diagonal back strap adjuster (Figure 8, Item 2), threading the horizontal back strap (Figure 8, Item 1) from the back to front above the floating bar, then front to back below the floating bar of the diagonal back strap adjuster (Figure 8, Item 2).

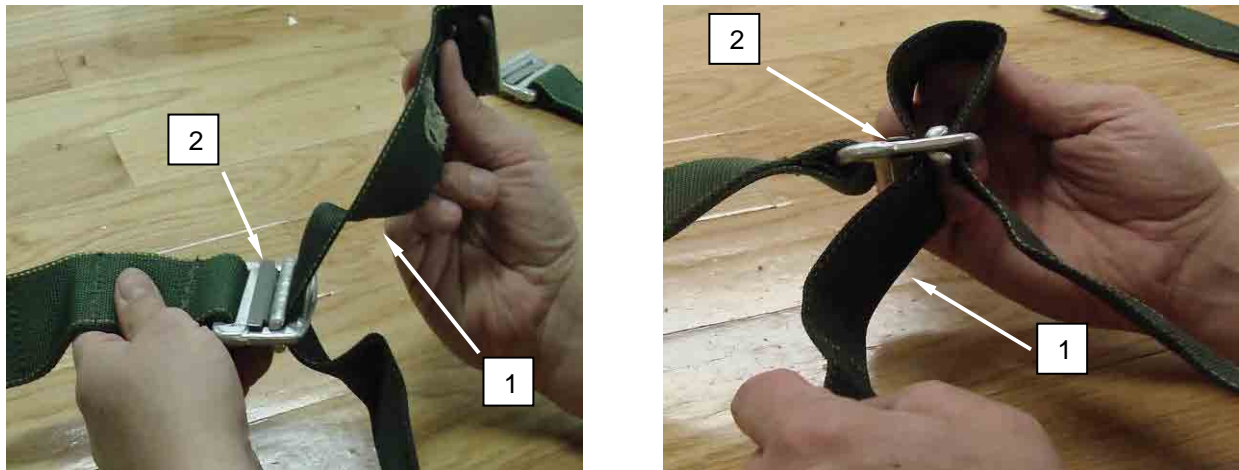

Figure 8. Route Horizontal Back Straps through Back Strap Adjuster.

13. Ensure that the harness assembly has no twists and that the diagonal back straps cross the right over the left horizontal back strap forming an X.
14. Mark the tuck tab assembly 1-inch from the bottom edge (Figure 9, Item 1) (opposite end) from the tuck tab stiffener (Figure 9, Item 2). This will help in proper placement of the tuck tab assembly on the upper main lift web assembly.



Figure 9. Tuck Tab Assembly.

REPLACE-CONTINUED

15. Using a glue gun place a small amount of glue on free running end on the upper main lift web assembly (Figure 10). The glue should be approximately ½ inch from the free running edge of the Type VII nylon webbing.



Figure 10. Apply Glue to the Upper Main Lift Web.

NOTE

The snap fasteners will be secured by wrapping the tabs around the upper main lift web assembly, ensure that the snap fasteners are installed correctly to allow for proper securing of the tuck tab assembly.

16. Position the tuck tab assembly and snap fastener (Figure 11, Item 1) so that the stiffener end of the tuck tab assembly (Figure 11, Item 2) is facing towards the shoulder comfort pad (Figure 11, Item 3).

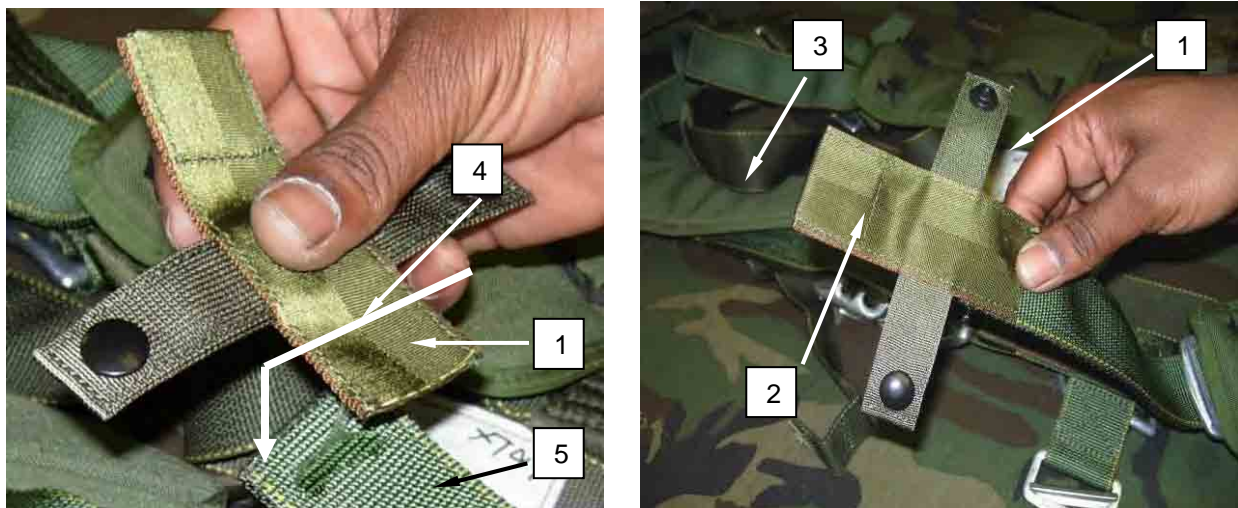

Figure 11. Proper Positioning of the Tuck Tab Assembly.

17. Align the 1-inch mark (Figure 11, Item 4) on the tuck tab assembly with the edge of the upper main lift web free running end (Figure 11, Item 5).
18. Repeat for opposite side.

REPLACE-CONTINUED

19. Cut two 6-inch lengths of Type IV, Class 2, 1-inch wide tape. These two lengths of tape will be used for the tuck tab retainer on the right and left upper main lift web assemblies.
20. Using a glue gun place a small amount of glue on the tuck tab assembly (Figure 12, Item 1) and place the tuck tab retainer (Figure 12, Item 2) flush with the left edge of the upper main lift web (Figure 12, Item 3)

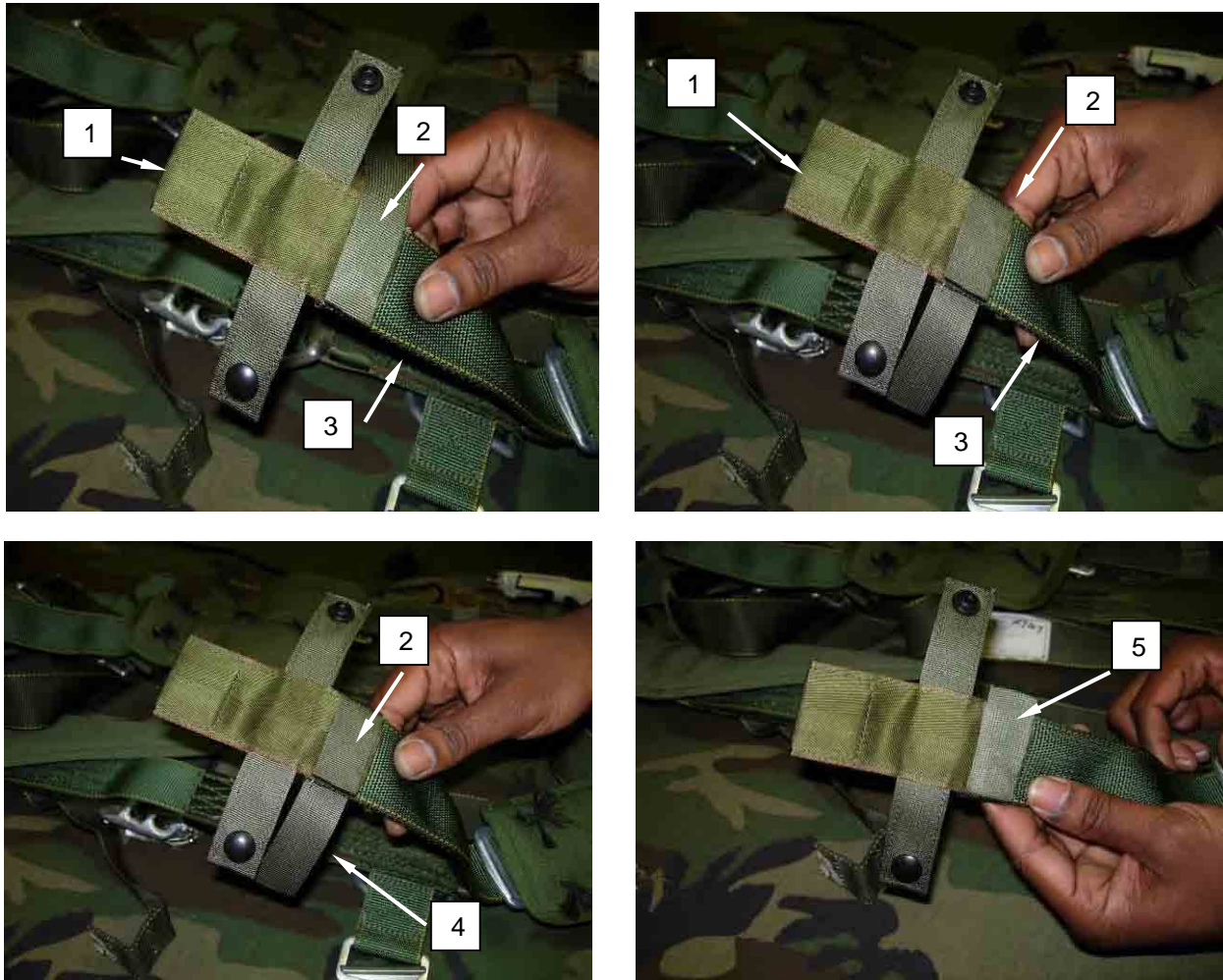

Figure 12. Attach Tuck Tab Assembly to the Upper Main Lift Web Assemblies.

21. Place a small amount of glue on the back side on the upper main lift web strap.
22. Working from left to right continue to wrap the tuck tab retainer (Figure 12, Item 2) free end around the upper main lift web (Figure 12, Item 3) and tuck tab assembly (Figure 12, Item 1).
23. Ensure to press firmly to allow the glue to hold the tuck tab retainer in place.
24. Place a small amount of glue on the tuck tab retainer (Figure 12, Item 2) top and continue to wrap the tuck tab retainer free end (Figure 12, Item 4) back over it self and secure in place (Figure 12, Item 5).
25. Repeat for the opposite side.

REPLACE-CONTINUED

26. Using a heavy duty sewing machine, size 5 nylon thread, 4 to 6 stitches per inch, sew the tuck tab assembly to the main lift web adjustment strap with a box stitch pattern (Figure 13).



Figure 13. Tuck Tab Retainer Sewn.

27. Repeat for opposite side.
28. Cut and sear any excess webbing from the tuck tab retainer even with the main lift web strap, be careful not to cut or sear into the tuck tab retainer, tuck tab assembly, and the main lift web strap.

REPLACE-CONTINUED

29. Place both main lift web assemblies (Figure 14, Item 1) on the small size setting, insert the tuck tab stiffener (Figure 14, Item 2) into the small size retainer (Figure 14, Item 3).

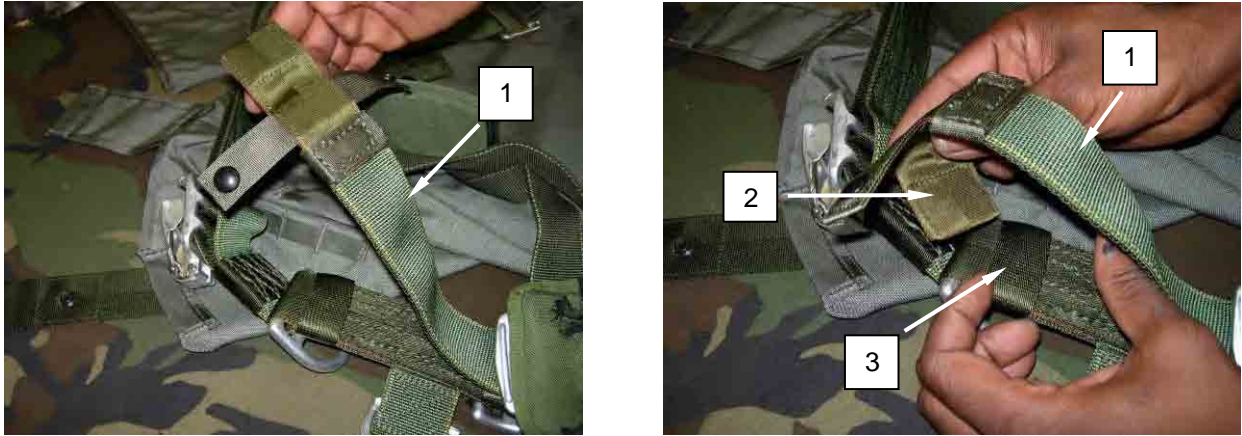

Figure 14. Upper Main Lift Web Assemblies Placed on Small Size Setting.

30. Secure tuck tab assembly (Figure 15, Item 1) wrapping the tuck tab retainer (Figure 15, Item 2) around the main lift web (Figure 15, Item 3) and secure the snap fastener (Figure 15, Item 4).

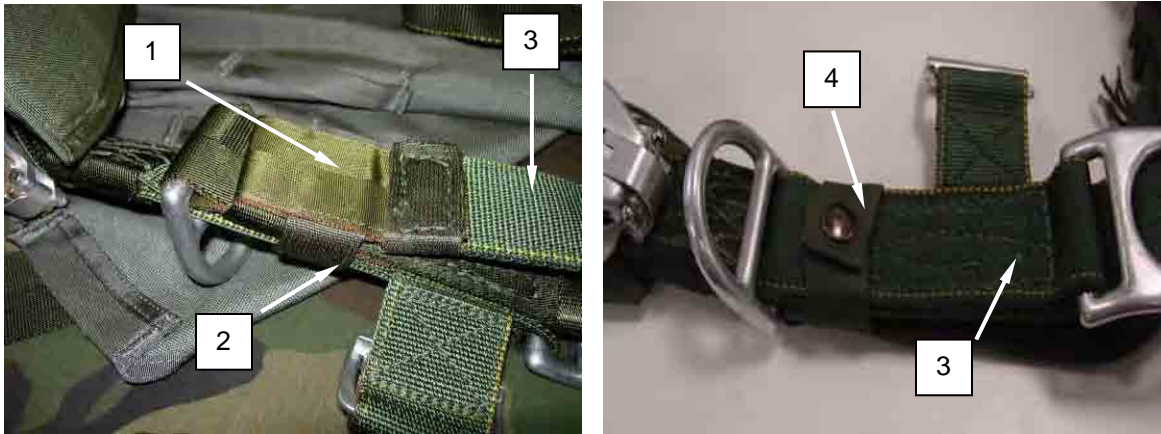

Figure 15. Secure Tuck Tab Assembly.

REPLACE-CONTINUED

31. Roll the free ends of the diagonal back strap and sew three rows of straight stitch using a heavy duty machine, size 3 nylon thread and 5 to 8 stitches per inch (Figure 16).



Figure 16. Roll and Sew Free End Diagonal Back Strap.

32. Inspect the harness assembly to ensure there are no twists, misrouting of the right and left upper main lift web assemblies, diagonal back straps, horizontal back strap, and lower saddle assembly.
33. Ensure to check for any missing stitching on the entire harness assembly.
34. If required re-stitch.

END OF TASK

END OF WORK PACKAGE

FIELD MAINTENANCE

T-11 SHOULDER PAD ASSEMBLY
REPAIR, REPLACE**INITIAL SETUP:****Tools and Special Tools**

Needle, Upholsterers, Curved, Size 5 (WP 0102, Item 32)
 Sewing Machine, Bartack, Industrial (WP 0102, Item 50)
 Sewing Machine, Medium Duty (WP 0102, Item 59)
 Stitch Removal Tool (WP 0102, Item 64)

Personnel Required

Parachute Rigger 92R1P (1)

References

WP 0016

Materials/Parts

Tape, Lacing And Tying, Nylon, A-A-52080-B3 (WP 0101, Item 41)
 Thread, Nylon, V-T-295, Type I or II, Size E, FG504 (WP 0101, Item 54)

Equipment Condition

Lay out on packing table or other suitable area.

REPAIR**Re-stitching**

1. Re-stitch the shoulder pad directly over the original stitch pattern, as closely as possible, using a medium-duty sewing machine, size E nylon thread that contrasts the color of the original stitching and material when possible, and 7 to 11 stitches per inches.

NOTE

When replacing a bar tack, remove the bar tack completely and replace it with a bar tack of the same size.

2. Lock each row of stitching with a 2-inch backstitch.

END OF TASK

REPLACE

1. Remove the stitching that holds the shoulder pad (Figure 1, Item 1) to the main lift web assembly.

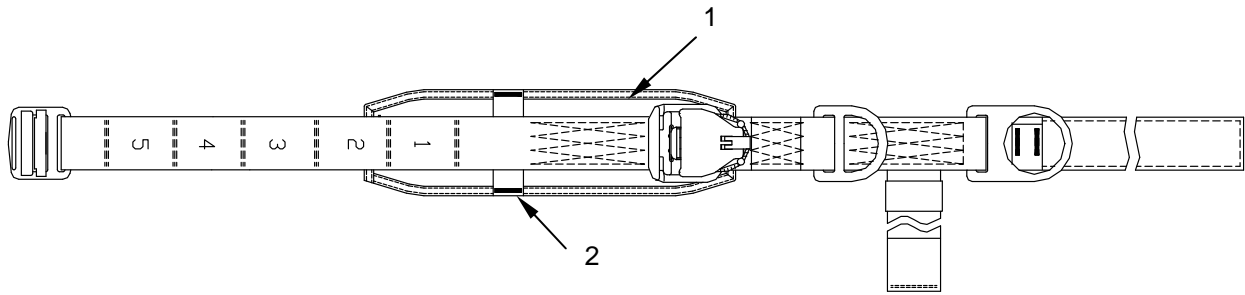

Figure 1. Harness Shoulder Pad.

2. Cut tacking that secures the shoulder pad to the upper main lift web.
3. Cut one end of the tape that is routed through sizing channel number 1 setting that secures the center of shoulder pad (Figure 1, Item 1) to the main lift web.
4. Take a new shoulder pad (Figure 1, Item 1) and position under the main lift web of the harness assembly. Ensure the hardware is facing up.
5. Route the sewn tape located in the center of the shoulder strap through sizing channel number 1 setting.
6. Using a bartack sewing machine, place a $\frac{1}{8}$ - x $\frac{7}{8}$ -inch, 42-stitch bartack on the sewn tape where it meets the shoulder pad (Figure 1, Item 2) so that the stitch does not exceed the edges of the tape.
7. Align the top of the shoulder pad (Figure 1, Item 1) with the top of the sizing channel.

NOTE

When sewing the bottom to the main lift web, ensure to sew $\frac{1}{2}$ inch below the bottom edge of the sizing channel strap.

8. Using a medium duty sewing machine, size E nylon thread, 7 to 11 stitches per inch, sew the binding of the shoulder pad to the main lift web.
9. Re-tack the shoulder pad onto the main lift web using one turn single of lacing and tying tape using a surgeon's locking knot (refer to WP 0016).
10. Re-tack the top portion of the shoulder pad to the upper main lift web assembly. The tacking should be routed down through the shoulder pad ensuring to capture the padded material and through the diagonal back strap sizing channel then back up through the shoulder pad then tie using a surgeon's knot locking knot.
11. Secure the bottom portion of the shoulder pad to the main lift web assembly. The tacking should be routed down through the shoulder pad ensuring to capture the padded material and through the main lift web material behind the female canopy release assembly, tying with a surgeon's knot locking knot.

END OF TASK**END OF WORK PACKAGE**

FIELD MAINTENANCE

EXCESS WEBBING KEEPER ASSEMBLY
REPLACE

INITIAL SETUP:

Tools

Heated Blade Cutter (WP 0102, Item 18)
Ruler, Tab, Metal, 16 Inches (WP 0102, Item 46)
Sewing Machine, Light Duty (WP 0102, Item 57)
Stitch Removal Tool (WP 0102, Item 64)

Personnel Required

Parachute Rigger 92R1P (1)

Materials/Parts

Pencil, Marking, China, White, A-A-87 (WP 0101, Item 31)
Thread, Nylon, V-T-295, Type I or II, Size E, FG504 (WP 0101, Item 54)
Webbing, Elastic, Type I, Class I, 1-Inch Wide, FG504 (WP 0101, Item 57)

Equipment Condition

Lay out on maintenance table or other suitable area.

REPLACE

1. Cut the damaged webbing retainer strap and remove from harness assembly.
2. Cut a 4½-inch length of Type I elastic webbing (Figure 1), ensuring both ends are straight and seared.

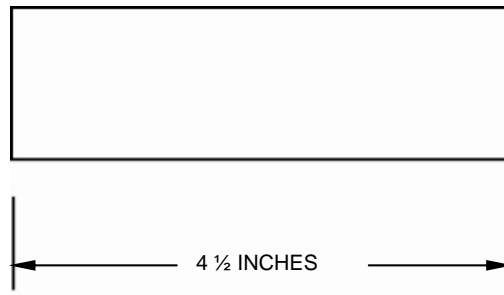

Figure 1. 4½-inch Length of Type I Elastic Webbing.

3. Fold the webbing in half and align the ends (Figure 2).

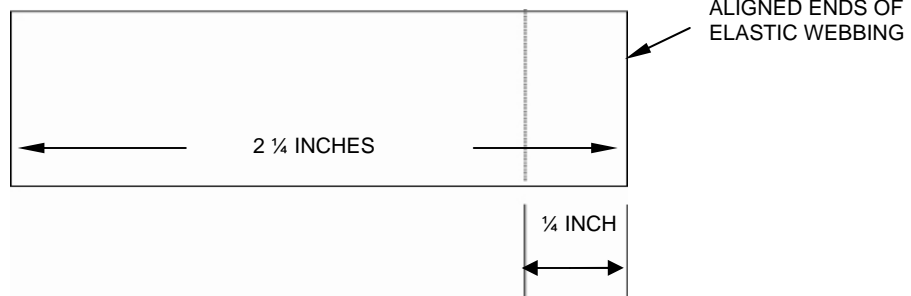

Figure 2. First Seam of Elastic Webbing.

REPLACE - CONTINUED

4. Using a lightweight sewing machine, size E nylon thread, 7 to 11 stitches per inch, sew across the webbing $\frac{1}{4}$ inch from the aligned ends.
5. Fold both ends over along the row of stitching (Figure 3).
6. Using a lightweight sewing machine, size E nylon thread, 7 to 11 stitches per inch, sew across the webbing $\frac{1}{16}$ inch from the ends (Figure 3). Ensure that the stitching goes through the two aligned ends of the webbing and one layer of the main webbing loop.

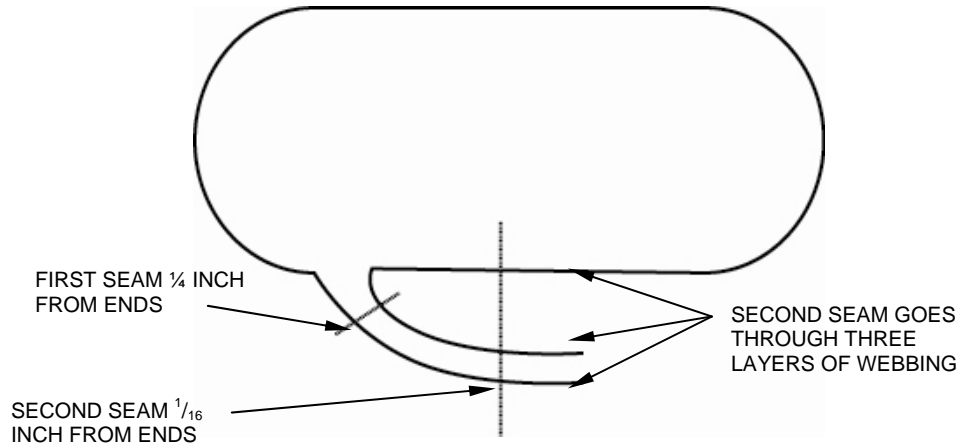

Figure 3. Loop Stitching Locations.

7. Turn the loop inside-out and slide into position on the appropriate strap (Figure 4).

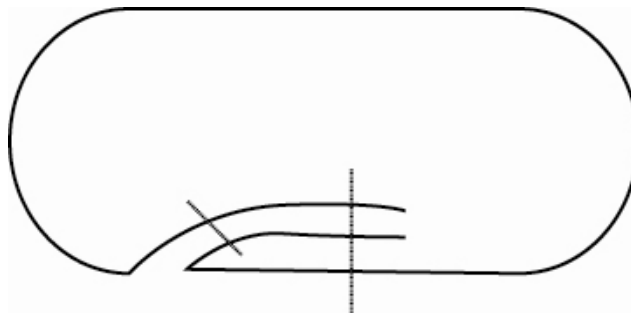

Figure 4. Completed Harness Webbing Retainer.

END OF TASK

END OF WORK PACKAGE

FIELD MAINTENANCE

T-11 RESERVE CANOPY ASSEMBLY
REPAIR

INITIAL SETUP:

Tools and Special Tools

Needle, Upholsterers, Curved, Size 3
(WP 0102, Item 31)
Sewing Machine, Light Duty (WP 0102,
Item 57)

Materials/Parts

Thread, Nylon, V-T-295, Type I or II, Size E,
FG504,(WP 0101, Item 54)

Equipment Condition

Unpacked

Personnel Required

Parachute Rigger 92R1P (1)

References

WP 0016
WP 0056
WP 0057
WP 0058
WP 0061
WP 0062
WP 0063

REPAIR

Re-stitching

Re-stitch reserve canopy using a light-duty sewing machine and size E thread nylon thread that contrasts the color of the original stitching and material when possible. Re-stitch directly over the original stitch pattern as closely as possible with 7 to 11 stitches per inch. Lock each row of stitching 2 inches at each end.

Refer to Table 1 for information on repair procedures for the T-11 Reserve Canopy.

Table 1. T-11 Reserve Canopy Repair References.

COMPONENT	WORK PACKAGE
General Fabric Repair	0016
Gore Panel	0056
Vent Panel	0057
Skirt Assist Ties	0058
Canopy Scoop	0061
Apex Vent Bridle Loop	0062
Suspension Line Attaching Loop	0063

END OF WORK PACKAGE

FIELD MAINTENANCE

T-11 RESERVE SUSPENSION LINE ASSEMBLY
REPLACE

INITIAL SETUP:

Tools

Crowfoot Attachment, Socket Wrench, 3/8-inch Drive, 7/16 Open end (WP 0102, Item 12)
Wrench, Adjustable, 8-Inch (WP 0102, Item 73)
Wrench, Torque, 0-300 Inch-pounds (WP 0102, Item 74)

Personnel Required

Parachute Rigger 92R1P (1)

References

WP 0008
WP 0058

Materials/Parts

Webbing, Textile, Cotton, Type I, 1/4-inch Wide, Natural (WP 0101, Item 68)

Equipment Condition

Unpacked

REPLACE

Replace Reserve Canopy Suspension Line

1. Place in proper layout IAW WP 0008.
2. Cut damaged line 6-inches above the connector link. Cut the skirt hesitator tie located inside the canopy. Remove suspension line (Figure 1, Item 1) from the canopy line-attaching loop (Figure 1, Item 2).
3. Align the new suspension line (Figure 1, Item 1) so that the cascade is closest to the canopy.



Figure 1. Attaching New Suspension Line to Attaching Loop.

REPLACE - CONTINUED

4. Attach a new suspension line (Figure 1, Item 1) to attaching loop (Figure 1, Item 2) with girth hitch.
5. Pass the other end through the opposite end of the suspension line loop.
6. Pull tight forming a girth hitch. Make sure that the cascade is facing towards the inside of the canopy.
7. Trace the new suspension line (Figure 2, Item 1) down beside the adjacent line that is being replaced. Ensure that all turns, tangles, twists and knots are removed.

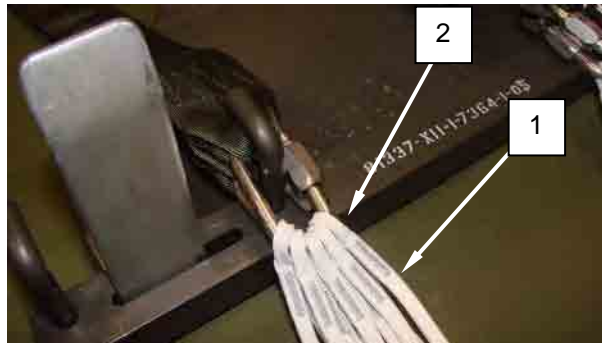

Figure 2. Attaching New Suspension Line to Connector Link.

8. Using an adjustable wrench loosen the barrel nut on the old connector link.

NOTE

Use of a line insertion tool or screwdriver will help in the transfer of suspension lines.

9. Remove all suspension lines sequentially and place on an appropriate tool.
10. Remove old connector link and discard.
11. Place new connector link on riser.
12. Transfer suspension lines sequentially back onto new connector link until the damaged line is reached.
13. Remove and discard damaged line.
14. Place new suspension line on new connector link.
15. Continue to transfer suspension lines back onto new connector link.
16. Conduct a continuity check IAW WP 0008.
17. Reinstall the skirt assist tie IAW WP 0058.

END OF TASK**END OF WORK PACKAGE**

FIELD MAINTENANCE

T-11 RESERVE EXTRACTOR ASSEMBLY
REPLACE

INITIAL SETUP:

Tools and Special Tools

Shears, Tailors, 12 inch (WP 0102, Item 61)

Personnel Required

Parachute Rigger 92R1P (1)

Materials/Parts

Cord, Spectra®, #1000, (700 lb. tensile strength)
(WP 0101, Item 18)

Equipment Condition

Lay out on packing table or other suitable area.

REPLACE

Remove Reserve Extractor

1. Arrange the canopy on the pack table with gore 1 on top.
2. Layout the extractor immediately above the apex ensuring the extractor vent bridle lines are free of turns, tangles and twists.
3. Remove the 12-inch length of one turn single Spectra® cord (Figure 1, Item 1) from one end of the apex extractor attaching loop (Figure 1, Item 2) through the looped end of the extractor vent bridle line (Figure 1, Item 3), and back through apex extractor attaching loop (Figure 1, Item 2).

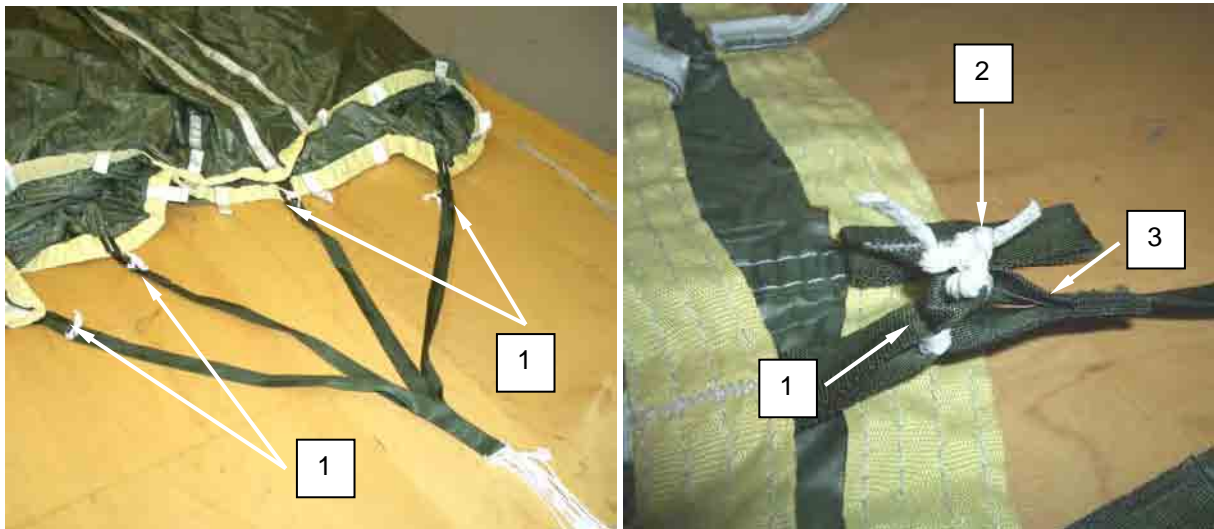

Figure 1. Remove Cord from Apex Extractor Attaching Loop.

4. Remove the remaining extractor vent bridle lines (Figure 1, Item 3) in the same manner.
5. Remove the reserve extractor.

REPLACE - CONTINUED**Attach Reserve Extractor**

1. Arrange the canopy on the pack table with gore 1 on top.

NOTE

Ensure the extractor vent bridle lines are straight and free of twists.

2. Layout the extractor immediately above the apex insuring the extractor vent lines are free of turns, tangles and twists.
3. Locate the four apex extractor attaching loops (Figure 2, Item 1) attached to the apex of main seam numbers 4, 9, 14 and 19 (the four attachment loops are OD in color for easy identification).

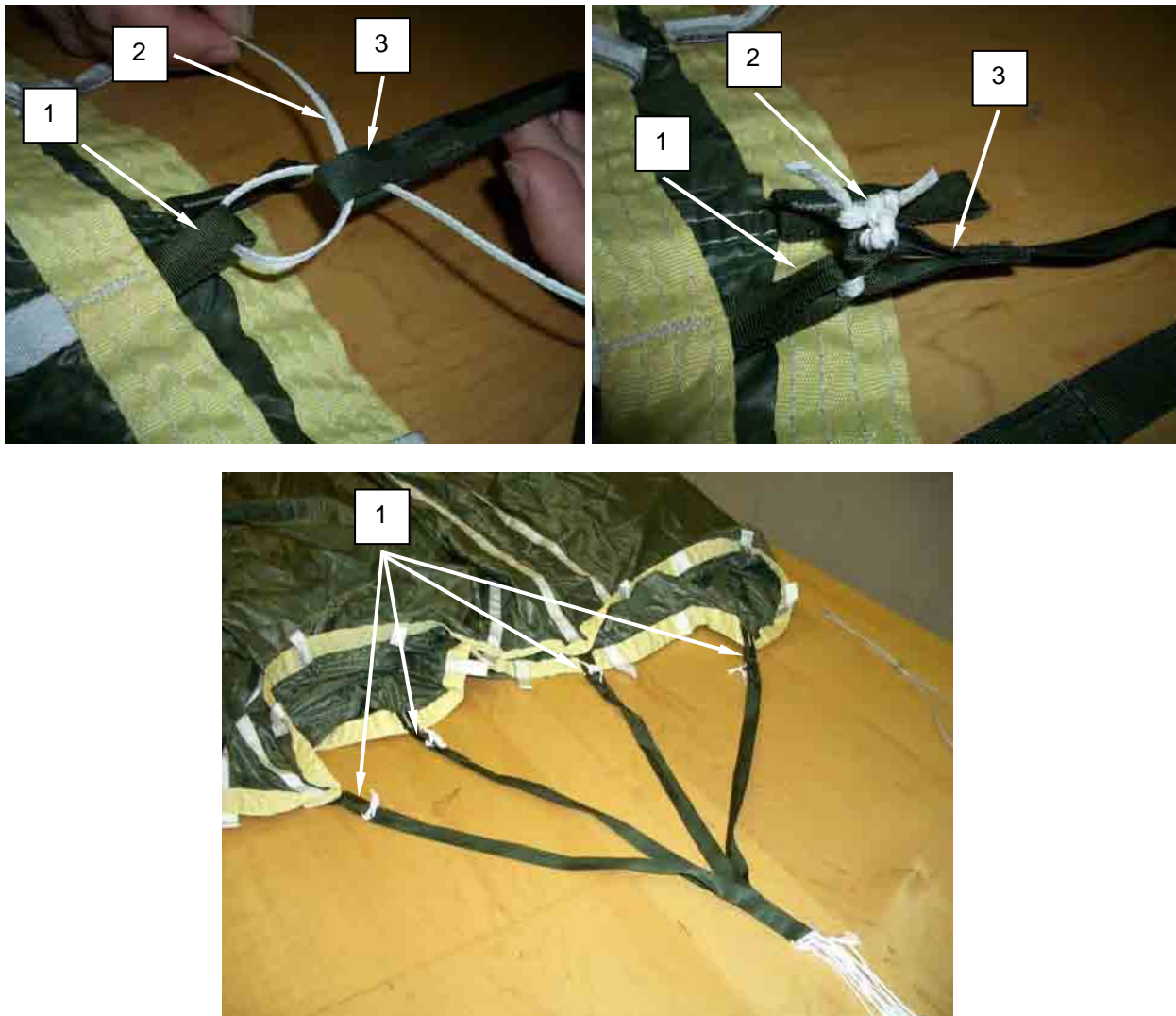

Figure 2. Attach Reserve Extractor Parachute.

4. Route one end of a 12-inch length of one turn single Spectra® cord (Figure 2, Item 2) through one end of the apex extractor attaching loop (Figure 2, Item 1), through the looped end of the extractor vent bridle line (Figure 2, Item 3), and back through apex extractor attaching loop (Figure 2, Item 1).

REPLACE - CONTINUED

5. Tightly secure the ends of the cord (Figure 2, Item 2) over the apex extractor-attaching loop (Figure 2, Item 1) using a surgeon's knot locking knot, with an overhand knot in the running end.
6. Trim excess to approximately 1-inch long.
7. Attach the remaining extractor vent bridle lines (Figure 2, Item 1) in the same manner.

END OF TASK**END OF WORK PACKAGE**

FIELD MAINTENANCE**T-11 RESERVE EJECTOR SPRING ASSEMBLY
TEST, REPLACE**

INITIAL SETUP:**Tools and Special Tools**

Test Tube, Spring Compression with 32 Pound
(WP 0102, Item 67)

Personnel Required

Parachute Rigger 92R1P (1)

References

WP 0084

Equipment Condition

Unpacked

TEST**NOTE**

The test tube (PVC pipe) and the 32-lb weight constitute the spring compression test set. The spring compression test set is locally manufactured IAW WP 0084.

Perform a compression test during initial receipt, during each re-pack and each time ejector spring is replaced. Allow the spring to remain in a relaxed state for up to 24 hours before testing (especially those that have been compressed/packed for 365 days).

Perform the spring compression test as follows:

CAUTION

Dropping the weight onto the spring will result in unnecessary replacement of the spring and cause irreparable damage to the material covering the spring.

1. Place the tube on a flat hard surface in the vertical position with the 6-inch slot closest to the floor.
2. Place the spring inside the tube.
3. Lower the 32-pound weight onto the spring.
4. Check to ensure that the spring is visible between the 6-inch slot in the tube.

TEST - CONTINUED

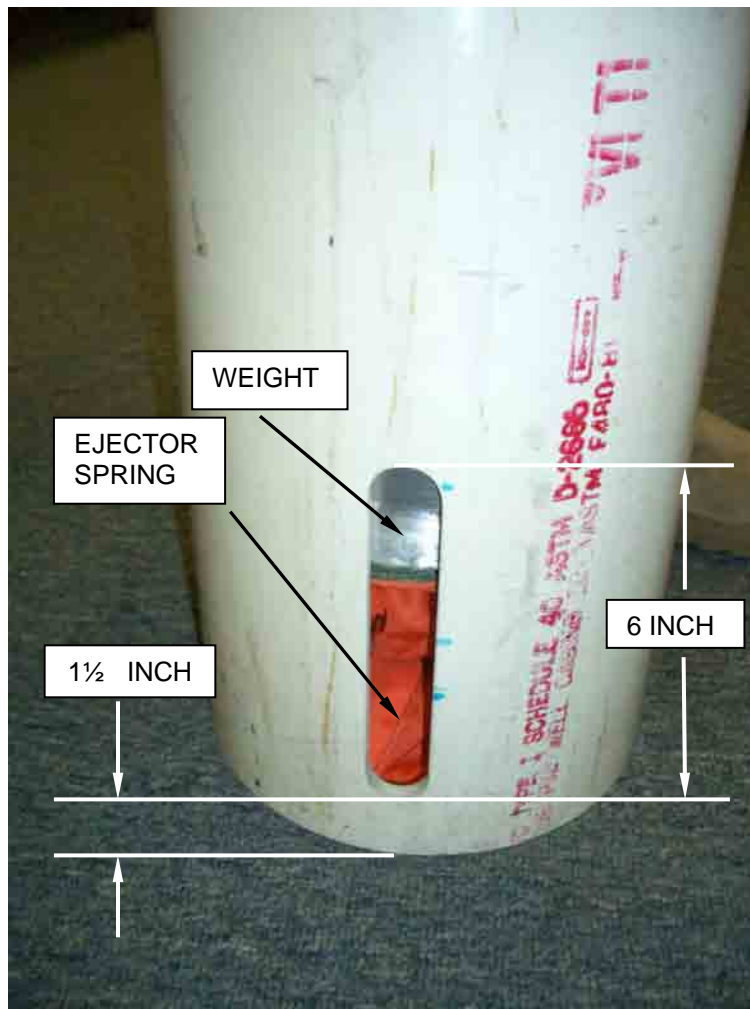

Figure 1. Spring Compression Test Tube.

5. If the top of the spring falls above or below the slot, discard and replace the ejector spring with a serviceable one from stock.

END OF TASK

REPLACE

Replace an unserviceable ejector spring with a serviceable one from stock.

END OF TASK

END OF WORK PACKAGE

FIELD MAINTENANCE
RESERVE CANOPY GORE PANELS
REPAIR

INITIAL SETUP:**Tools and Special Tools**

Needle, Upholsterers, Size 3 (WP 0102, Item 31)
Sewing Machine, Light-Duty (WP 0102, Item 57)
Shears, Tailors, 12 Inch (WP 0102, Item 61)
Stitch Removal Tool (WP 0102, Item 64)

Personnel Required

Parachute Rigger 92R1P (1)

Materials/Parts

Brush, Stenciling (WP 0101, Item 6)
Cloth, Parachute, Nylon, Low Permeability, Type IV, FG504, (WP 0101, Item 12)
Cloth, Parachute, Nylon, Low Permeability, 1.5 oz. per sq yd, FG504 (WP 0101, Item 13)
Stencil Board, Oiled (WP 0101, Item 37)
Thread, Nylon, V-T-295, Type I or II, Size E, FG504 (WP 0101, Item 54)

References

WP 0016
WP 0018

Equipment Condition

Unpacked

REPAIR**NOTE**

Parachute mending cloth IS NOT AUTHORIZED on the T-11 Reserve. Darning is not authorized on the T-11R canopy.

Repair Gore Panels 1, 2 and 3

Repair gore panels 1, 2, and 3 IAW patching procedures detailed in WP 0016, and stenciling procedures detailed in WP 0018 and the following guidelines:

1. Four-sided patches only with square corners.
2. No patch larger than 8- by 8-inches is authorized. Any damage that requires a patch larger than 8- by 8-inches will require replacement of the entire canopy.
3. Panels 1 through 3 (1.1 oz material), a maximum of three patches per panel providing the area does not exceed 50 percent of the panel. Any damage in excess of 50 percent will require the entire canopy to be replaced.
4. A repair to panel 1 that requires patching against the lower lateral band will require that the patch extend over the whole width of the lower lateral band and all rows of stitching in the lower lateral band must be re-stitched across patch material.
5. Damage closer than 1 inch of the main seam will require the entire reserve assembly to be replaced.

REPAIR – CONTINUED**Repair Gore Panels 4 and 5**

Repair gore panels 4 and 5 IAW patching procedures detailed in WP 0016 and the following guidelines:

1. Four-sided patches only with square corners.
2. No patch larger than 8- by 8-inches is authorized. Any damage that requires a patch larger than 8- by 8-inches will require replacement of the entire canopy.
3. Panels 4 and 5 (1.5 oz material), maximum of one patch per panel providing the patch it is not within 1 inch of a main seam. Damage closer than 1 inch of the main seam will require the entire reserve assembly to be replaced.

END OF TASK**END OF WORK PACKAGE**

FIELD MAINTENANCE

T-11 RESERVE VENT PANEL
REPAIR, REPLACE

INITIAL SETUP:

Tools and Special Tools

Sewing Machine, Double Needle (WP 0102, Item 54)
 Sewing Machine, Zig-Zag (WP 0102, Item 60)
 Shears, Tailors, 12 Inch (WP 0102, Item 61)
 Stitch Removal Tool (WP 0102, Item 64)

Personnel Required

Parachute Rigger 92R1P (1)

Materials/Parts

Thread, Nylon, V-T-295, Type I or II, Size E, FG504 (WP 0101, Item 54)

Equipment Condition

Unpacked

REPAIR

NOTE

Only straight tears are repaired. Do not repair if part of the mesh is missing. Repairs are allowable if a single cell is cut. Repair is not allowed for damaged to two adjacent cells.

No single repair more than 6 inches in length. No more than four repairs per panel. No more than a total of 12 inches of repaired damage. Repairs may not cross one another.

A single needle sewing machine may be used if a double needle machine is unavailable.

1. Invert canopy (Figure 1).

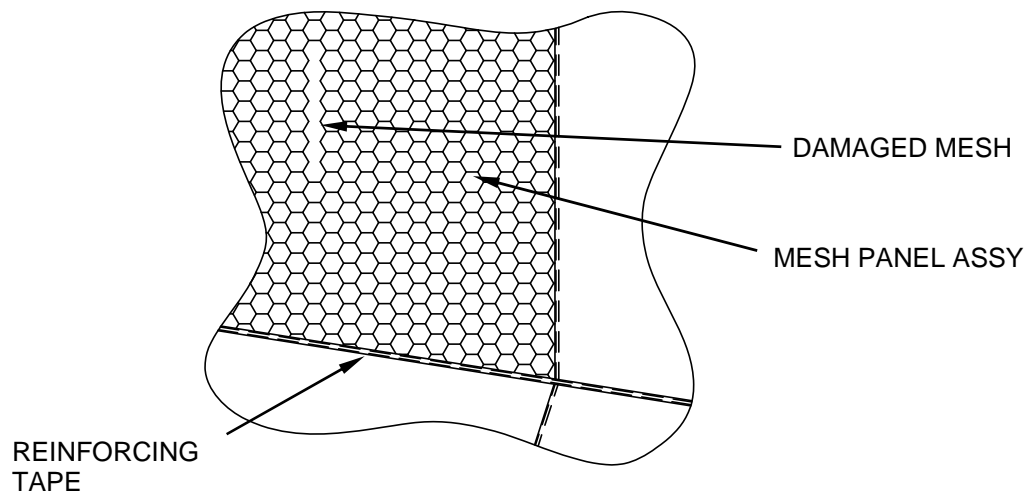

Figure 1. Repair Damaged Vent Panel.

REPAIR – CONTNUED

2. Pinch the torn edges together.
3. Using a zig-zag sewing machine set to $\frac{3}{16}$ -inch wide stitch and size E nylon thread, start sewing at least 1 inch before the tear and at least $\frac{1}{8}$ -inch in from the edge.
4. Sew the length of the tear, binding the torn edges together. Continue sewing to at least 1-inch past the tear (Figure 2).

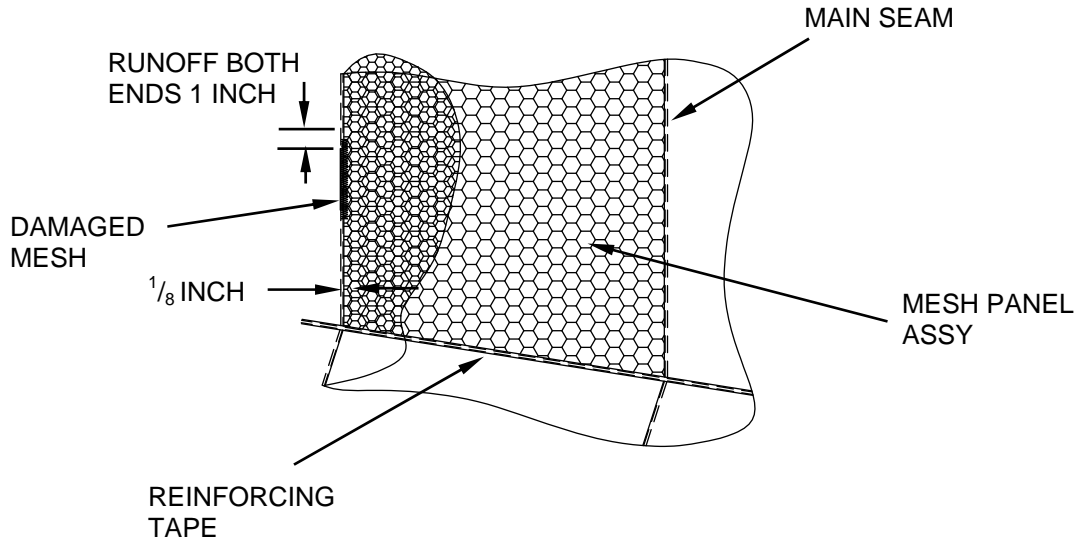

Figure 2. Sew Before Tear.

5. Verify that the repair is functional by using hand tension to pull the mesh perpendicular to the repair. If it pulls apart, attempt the repair again or replace the entire mesh panel.

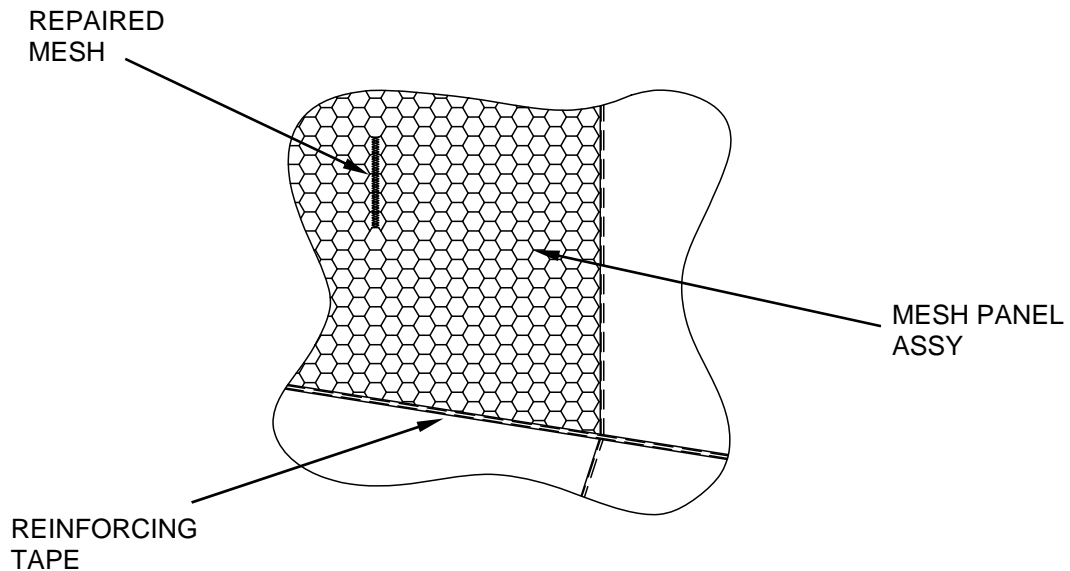

Figure 3. Verify Repair Is Functional.

END OF TASK

REPLACE**NOTE**

Each mesh panel is a complete assembly that is sewn over a finished opening. Replacement entails removing the damaged mesh panel assembly and sewing a new one in the same location.

1. Carefully remove the damaged mesh panel assembly (Figure 4). Take note on how the mesh panel is attached.

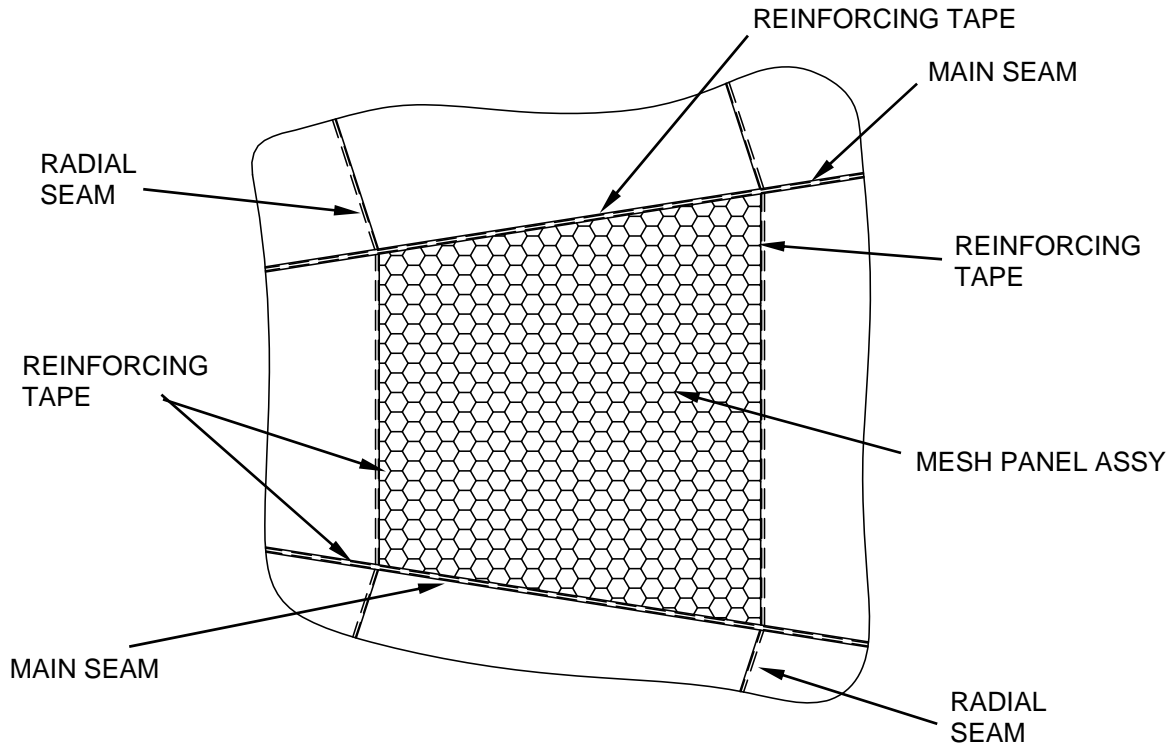

Figure 4. Replace Damaged Mesh Panel.

2. Clean the area by removing all loose pieces of thread.
3. Take a new mesh panel assembly and in the same manner as the original mesh panel was positioned, align an upper corner of the new mesh panel with an upper inside corner of the opening.
4. Laying the reinforcement tape on top of the new netting and main seam for at least 4 inches beyond the mesh panel with the end folded under a minimum of $\frac{1}{4}$ inch on both ends.
5. Repeat for the opposite side.
6. Using a double needle sewing machine, size E nylon thread, 7 to 11 stitches per inch, begin sewing at least 4 inches before the end of the mesh panel reinforcement tape and sew the entire radial of the new mesh panel to the canopy, sewing past the other end by at least 4 inches. Repeat for the other radial.
7. Using a double needle sewing machine, size E nylon thread, 7 to 11 stitches per inch, sew the top of the new mesh panel to the opening. Backstitch both ends a minimum of $\frac{1}{2}$ inch. Repeat for the bottom.

END OF TASK

END OF WORK PACKAGE

FIELD MAINTENANCE
RESERVE CANOPY SKIRT ASSIST TIES
REPLACE

INITIAL SETUP:**Tools and Special Tools**

Scissors, 8 inch (WP 0102, Item 48)

Personnel Required

Parachute Rigger 92R1P (1)

Materials/PartsWebbing, Textile, Cotton, Type I, 1/4-inch Wide,
Natural (WP 0101, Item 68)**Equipment Condition**

Unpacked

REPLACE

Procedure begins on next page.

REPLACE - CONTINUED**WARNING**

If the reserve canopy has been involved in a known high-speed malfunction and deployed, it must be removed from service immediately. Failure to do so could cause a catastrophic failure on any subsequent re-use. If the reserve canopy has been deployed for any reason, the reason for the deployment **MUST** be ascertained to determine the continued serviceability of the reserve parachute.

NOTE

If the canopy has been deployed, the skirt assist line attachments must be removed and replaced with new cotton webbing.

Each suspension line is cascaded near the skirt of the canopy. The continuous lines attach to the skirt and the cascaded lines are attached to loops on the corresponding seam 19 ½ inches on the inside of the canopy. The cascaded portions are called "Skirt Assist Lines" and aid in inflation of the canopy. During high-speed deployments the skirt assist lines break free of the canopy to dampen the opening shock. During low speed deployments they remain attached and assist in the deployment. During normal repack, the skirt assist attachments should be inspected but it is not necessary to replace them unless the canopy has been deployed.

1. Remove cotton webbing (Figure 1, Item 1) from skirt assist line attaching loops (Figure 1, Item 2).



Figure 1. Install Skirt Assist Ties.

2. Route one end of a 12-inch length of Type I, ¼-inch, cotton webbing, one turn single, through one end of the skirt assist line attaching loop, through the looped end of the skirt hesitator line, and back through skirt assist line attaching loop.

END OF TASK

REPLACE - CONTINUED**Install Skirt Assist Ties**

1. Starting with line 1, follow the inside radial seam until you run into the skirt hesitator line attaching loop (Figure 1, Item 2).
2. Route one end of a 12-inch length of one turn single, Type I, ¼-inch, cotton webbing through one end of the skirt assist line attaching loop, through the looped end of the skirt hesitator line, and back through skirt assist line attaching loop.
3. Secure the ends of the cotton webbing (Figure 1, Item 1), over the skirt assist line attaching loop (Figure 1, Item 2), with a surgeon's knot and locking knot.
4. Trim the excess to within ½ inch.
5. Repeat steps 1 through 3 with the additional 19 suspension lines.

END OF TASK**END OF WORK PACKAGE**

FIELD MAINTENANCE

RESERVE SUSPENSION LINE PARACHUTE CONNECTOR LINK
REPLACE**INITIAL SETUP:****Tools and Special Tools**

Crowfoot Attachment, Socket Wrench, 3/8-inch Drive, 7/16 Open end (WP 0102, Item 12)
 Knife, Pocket (WP 0102, Item 25)
 Needle, Upholsterers, Curved, Size 5 (WP 0102, Item 32)
 Wrench, Adjustable, 8-inch (WP 0102, Item 73)
 Wrench, Torque, 0-300 Inch-pounds (WP 0102, Item 74)

Materials/Parts

Tape, Lacing and Tying, Nylon, A-A-52080-B-3 (WP 0101, Item 41)

Personnel Required

Parachute Rigger 92R1P (1)

References

WP 0015

Equipment Condition

Unpacked

REPLACE

1. Place the reserve canopy and all components on the packing table.

NOTE

A packing T-bar may be used to assist in routing of apex hook lanyard.

2. Working in a counterclockwise direction, pass the apex hook lanyard (Figure 1, Item 1) through all of the green and white loops (Figure 1, Item 2) at the apex.

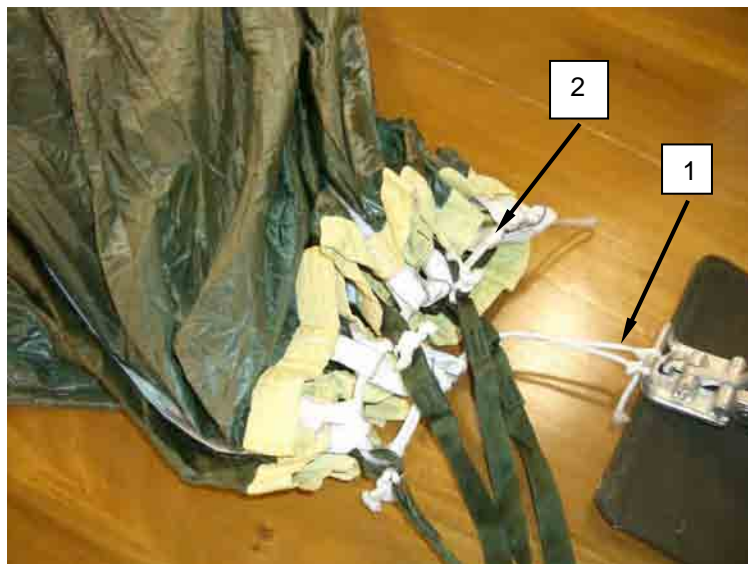

Figure 1. Passing Apex Hook Lanyard through All Apex Loops.

REPLACE - CONTINUED

3. Cut a 24-inch length of Ticket, 8/4 cotton thread (orange) (Figure 2, Item 1). Route one end through the loop of the apex hook lanyard (Figure 2, Item 2).
4. Attach running end of the apex hook lanyard to the apex hook (Figure 2, Item 3).

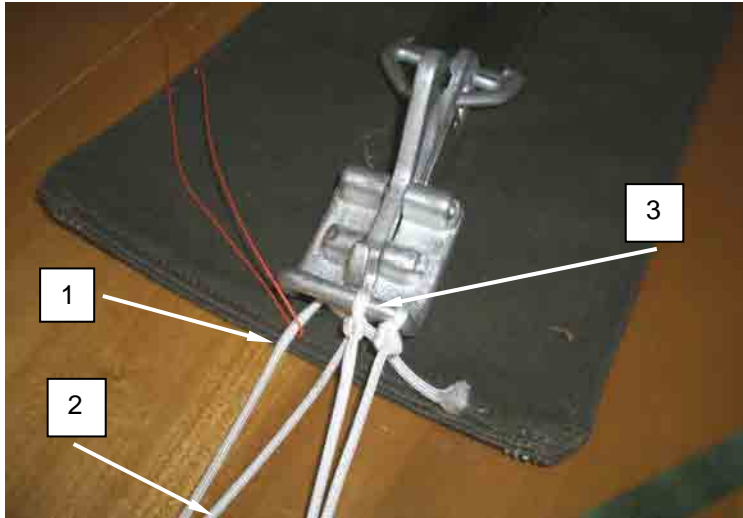

Figure 2. Routing the Ticket 8/4 Cotton Thread through Loop of Apex Hook Lanyard.

5. Place the reserve pack tray (Figure 3, Item 1) on the pack table with the reserve connector snaps (Figure 3, Item 2) at the lower end of the pack table and the connector links (Figure 3, Item 3) on the tension plate adapter (Figure 3, Item 4). Ensure the gates of the connector snaps are facing downward and the butterfly portions of the connector snaps are facing outward.

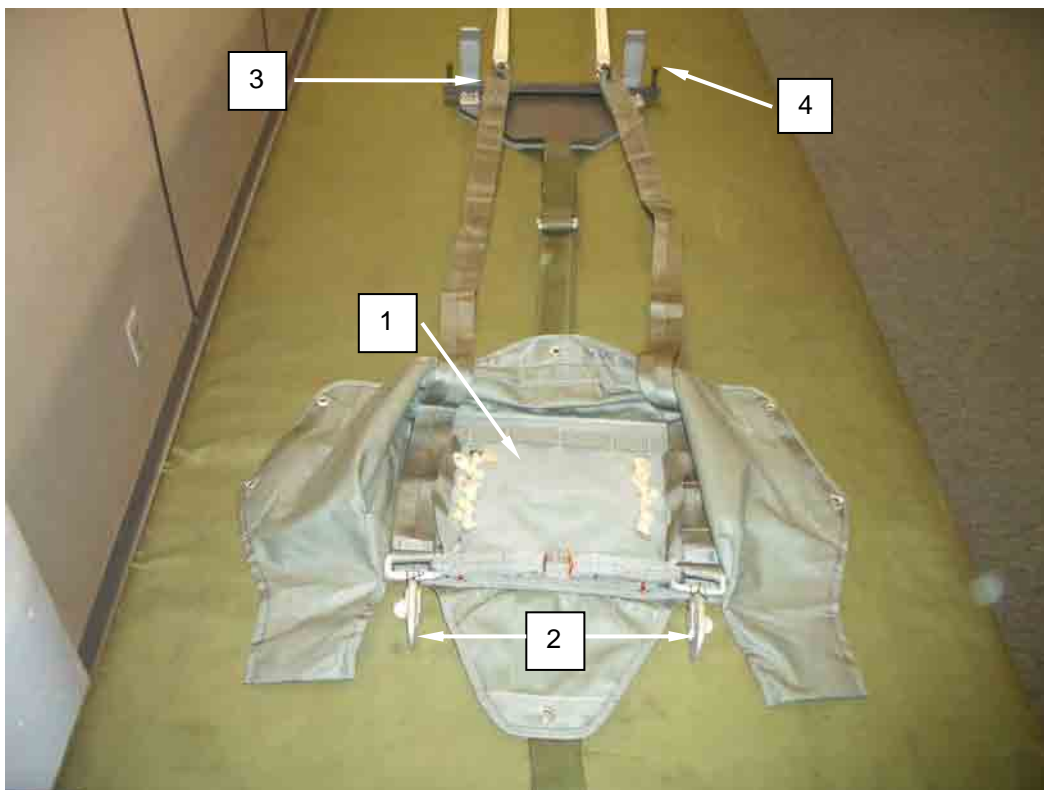

Figure 3. Placing Connector Links on Tension Plate Adapter.

REPLACE - CONTINUED

6. Cut and remove tacking (Figure 4, Item 1) from risers (Figure 4, Item 2).

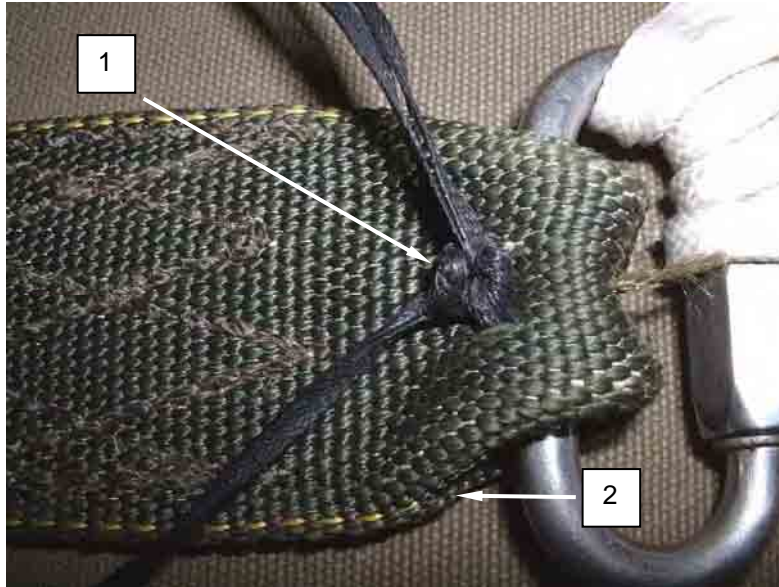

Figure 4. Remove Tacking.

NOTE

Use an appropriate tool to assist with line continuity.

7. Using an adjustable wrench, loosen barrel nuts (Figure 5, Item 1) on connector links (Figure 5, Item 2).

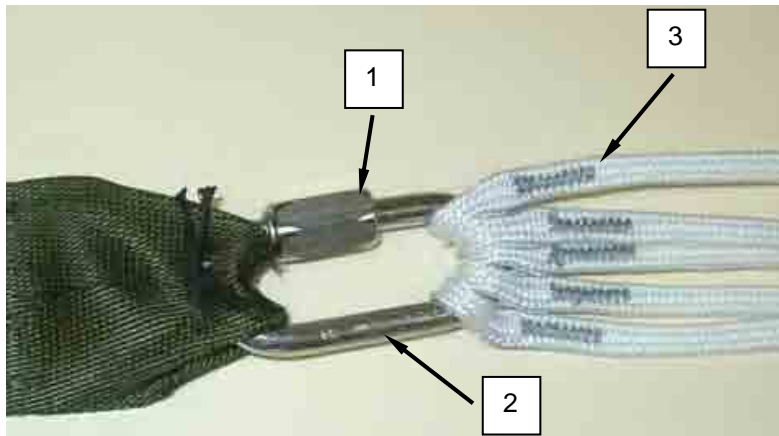

Figure 5. Replace Connector Links.

REPLACE - CONTINUED

8. Rotate each connector link (Figure 6, Item 1) sideways on the short portion.
9. Remove reserve risers (Figure 6, Item 2).
10. Remove suspension lines (Figure 6, Item 3), start in sequential order with left riser groups then right riser groups attached to connector links, and discard unserviceable links.

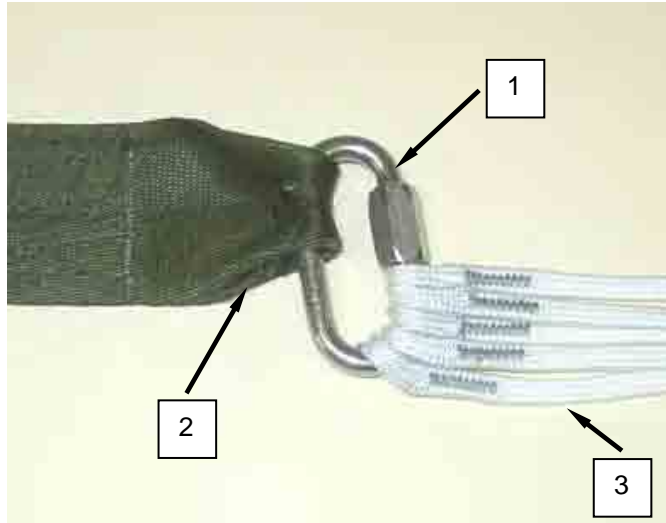

Figure 6. Rotate Connector Link to Riser.

REPLACE - CONTINUED

11. Position replacement connector links with nylon patch so that barrels face inboard and tighten downward to lower end of table. Attach suspension lines to their corresponding connector links without crossing. Ensure the suspension lines are closest to the barrel end of the connector link.

NOTE

Connector link barrel nuts must be oriented so they face inboard and tighten downward.

Suspension lines 1 through 20 are divided into two groups, number 1 through 10 in the left group and number 11 through 20 in the right group.

12. Place the left set of connector links (Figure 7, Item 1) on the left post (Figure 7, Item 2) of the tension plate adapter and the right set of connector links (Figure 7, Item 3) on the right post (Figure 7, Item 4) of the tension plate adapter.

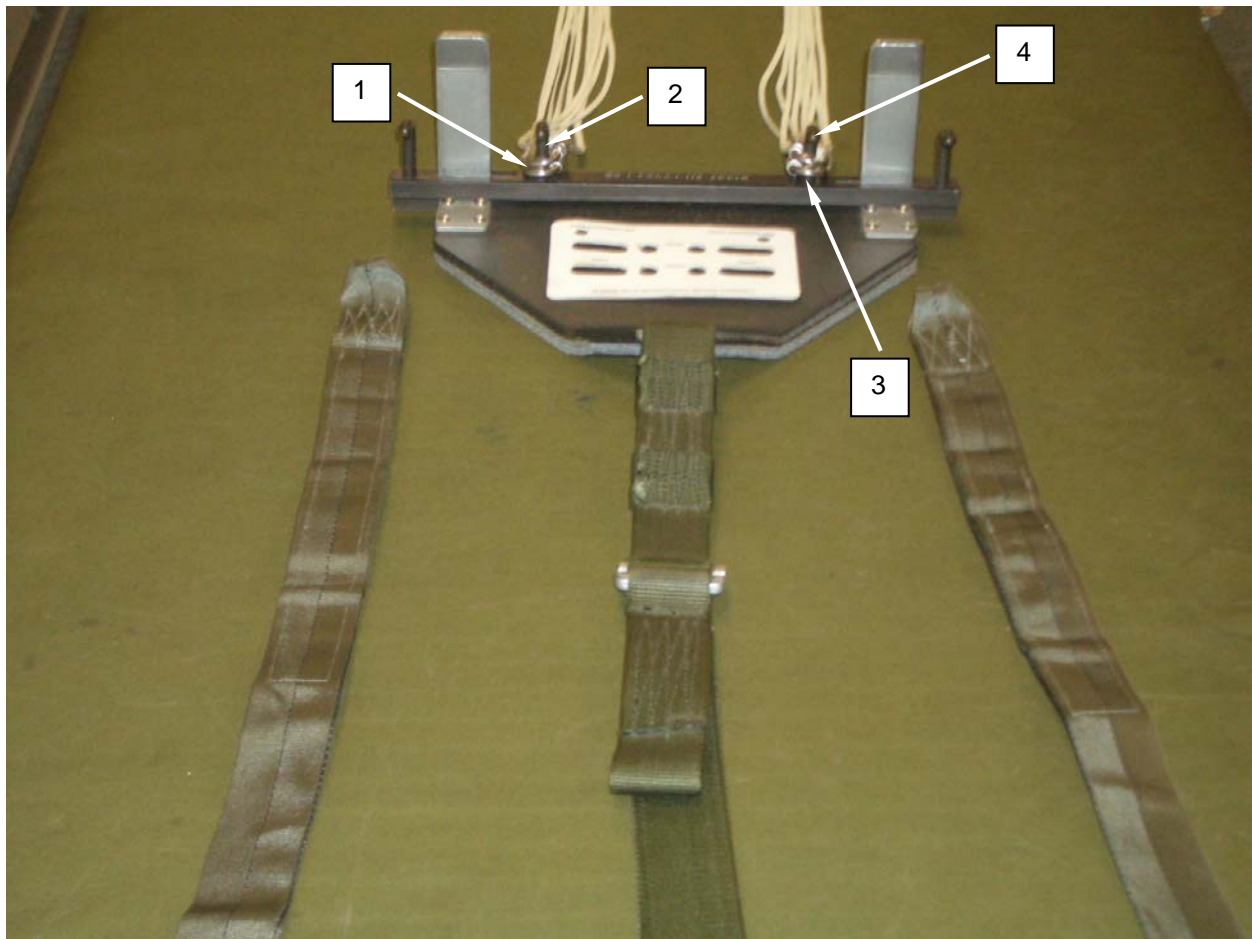

Figure 7. Riser Connector Links.

REPLACE - CONTINUED

NOTE

Two personnel are required for a line continuity check. The first person will be at the connector links to ensure lines are properly located on connector links. The second person will be at the lower lateral band calling off properly sequenced suspension lines.

- 13. Conduct a continuity check in accordance with Figure 8 below.
- 14. Top left suspension line group. Line 1 (inside top) followed in sequence by 2, 3, 4, 5 (outside top) runs from the canopy, to the top left connector link.
- 15. Bottom left suspension line group. Line 6 (outside bottom) followed in sequence by 7, 8, 9, 10 (inside bottom) runs from the canopy, to the bottom left connector link.
- 16. Bottom right suspension line group. Line 11 (inside bottom) followed in sequence by 12, 13, 14, 15 (outside bottom) runs from the canopy, to the bottom right connector link.
- 17. Top right suspension line group. Line 16 (outside top) followed in sequence by 17, 18, 19, 20 (inside top) runs from the canopy, to the top right connector link.



Figure 8. Suspension Line Groups.

- 18. Loosely connect connector links to appropriate riser.
- 19. Perform a four line check IAW "Perform a Four Line Check" in WP 0015.

REPLACE - CONTINUED

CAUTION

Do not use vise grips or other type pliers to hold connector link body when tightening, as damage to connector link can occur.

NOTE

Ensure torque wrench is calibrated by TMDE office prior to use.

20. Using a torque wrench with crowfoot adapter, tighten barrel nut (Figure 9, Item 1) on connector link (Figure 9, Item 2) to 50 inch-pounds.

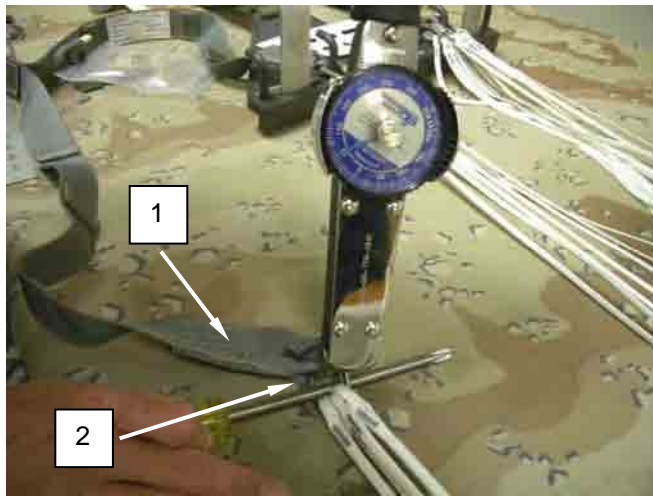

Figure 9. Tighten Barrel Nut on Connector Link.

21. Remove connector links and risers from the tension plate adapter.
22. Rotate the riser (Figure 10, Item 1) sideways on the long portion of the connector link (Figure 10, Item 3) positioning the riser to the long portion of the connector link opposite the barrel nut.
23. Tack each riser (Figure 10, Item 1) with a 12-inch length of lacing and tying tape, one turn double (Figure 10, Item 4). Pass the upholsterer's needle (Figure 10, Item 5) tight against the body of the connector link (Figure 10, Item 3) with running ends toward top when finished.

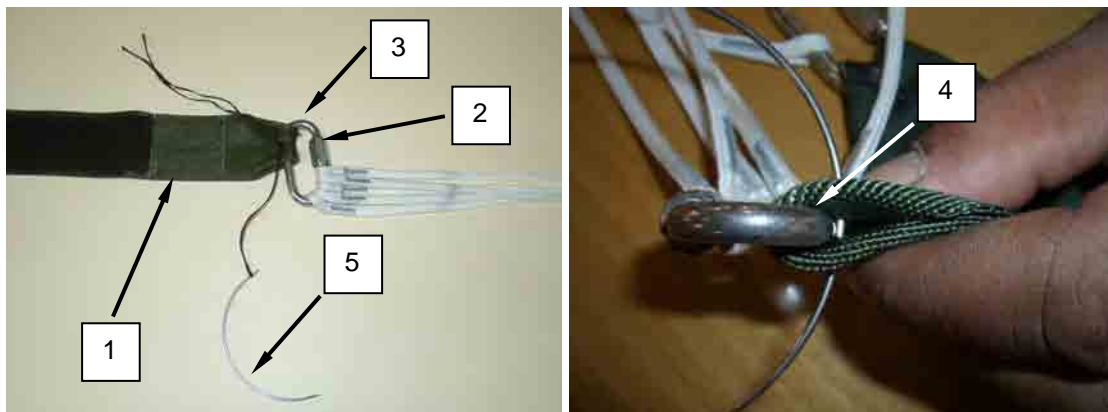

Figure 10. Tack Riser with Lacing and Tying Tape.

REPLACE - CONTINUED

24. Secure with a surgeon's knot locking knot, ensuring the knot is toward the top. Trim the running ends to $\frac{1}{2}$ inch.
25. Rotate the connector link (Figure 11, Item 1) back in place.

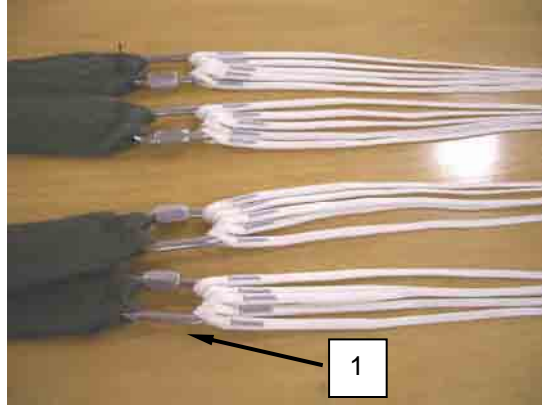

Figure 11. Rotating Risers to Lower Portion of Connector Link.

END OF TASK

END OF WORK PACKAGE

FIELD MAINTENANCE**T-11 RESERVE PROTECTION CAP ASSEMBLY
REPLACE**

INITIAL SETUP:**Equipment Condition**

Unpacked

Personnel Required

Parachute Rigger 92R1P (1)

REPLACE

If a protection cap is found to have damage it must be replaced with a new one, no exceptions.

END OF TASK**END OF WORK PACKAGE**

FIELD MAINTENANCE
RESERVE CANOPY SCOOP
REPAIR

INITIAL SETUP:**Tools and Special Tools**

Sewing Machine, Light-Duty (WP 0102, Item 57)
Shears, Tailors, 12 inch (WP 0102, Item 61)
Stitch Removal Tool (WP 0102, Item 64)

Personnel Required

Parachute Rigger 92R1P (1)

References

WP 0016

Materials/Parts

Cloth, Parachute, Nylon, Low Permeability,
Ripstop, Type IV, FG504 (WP 0101, Item 12)
Thread, Nylon, V-T-295, Type I or II, Size E,
FG504 (WP 0101, Item 54)

Equipment Condition

Unpacked

REPAIR

Re-stitching. Re-stitch reserve canopy scoops using a light duty sewing machine and size E nylon thread as closely as possible with 7 to 11 stitches per inch. Lock each row of stitching 2 inches at each end.

Repair canopy scoop IAW WP 0016, and the following guidelines:

1. 4-sided patches only with rounded or square corners.
2. Canopy scoop, maximum of one patch per scoop providing the area does not exceed 50 percent of the scoop. Any damage in excess of 50 percent will require reserve assembly to be replaced.

END OF TASK**END OF WORK PACKAGE**

FILED MAINTENANCE

RESERVE CANOPY APEX VENT BRIDLE LOOP
REPAIR, REPLACE**INITIAL SETUP:****Tools and Special Tools**

Heated Blade Cutter (WP 0102, Item 18)
 Sewing Machine, Bartack, Industrial (WP 0102, Item 50)
 Shears, Tailors, 12 inch (WP 0102, Item 61)
 Stitch Removal Tool (WP 0102, Item 64)
 Tape, Measuring (WP 0102, Item 65)

Personnel Required

Parachute Rigger 92R1P (1)

Materials/Parts

Thread, Nylon, V-T-295, Type I or II, Size E, FG504 (WP 0101, Item 54)
 Webbing, Nylon, Type I, Class 2, 9/16-inch wide, Natural (WP 0101, Item 63)

Equipment Condition

Unpacked

REPAIR**CAUTION**

Stitch removal requirements will vary according to the type of item being repaired. Due to the unique type of stitch formations found on the T-11 Reserve, use of a stitch removal tool is mandated when removing Bartack, Box X, or Double Box X stitch formations.

If bartack stitching requires repair, bartacks will be completely removed and a new bartack will be replaced with the same stitch length and width.

END OF TASK

REPLACE**WARNING**

Replacement of load bearing vent bridle loops (green) is prohibited. Only non-load bearing (white) vent bridle loops are authorized for replacement. Failure to heed this warning may result in serious injury or death to parachutist.

1. Carefully remove damaged apex vent bridle loop.
2. Cut a 5-inch length of 1-inch wide Type I webbing and mark at 2 inches and 4 inches.
3. Fold the new loop at the 2-inch mark and again at the 4-inch mark as shown below.



Figure 1. Folding a New Loop.

4. Using a bartack sewing machine size E nylon thread, place a $\frac{1}{8}$ - x $\frac{3}{4}$ -inch, 42-stitch bartack in the same place as original loop.

END OF TASK

END OF WORK PACKAGE

FIELD MAINTENANCE**RESERVE CANOPY SUSPENSION LINE ATTACHING LOOP
REPAIR**

INITIAL SETUP:**Tools and Special Tools**

Heated Blade Cutting (WP 0102, Item 18)
Sewing Machine, Bartack, Industrial (WP 0102,
Item 50)
Sewing Machine, Zig-Zag (WP 0102, Item 60)
Shears, Tailors, 12 inch (WP 0102, Item 61)
Stitch Removal Tool (WP 0102, Item 64)
Tape, Measuring (WP 0102, Item 65)

Personnel Required

Parachute Rigger 92R1P (1)

Materials/Parts

Thread, Nylon, V-T-295, Type I or II, Size E,
FG504 (WP 0101, Item 54)
Webbing, Nylon, Type I, Class 2, 9/16-inch wide,
Natural (WP 0101, Item 63)

Equipment Condition

Unpacked

REPAIR**CAUTION**

Stitch removal requirements will vary according to the type of item being repaired. Due to the unique type of stitch formations found on the T-11 Reserve, use of a stitch removal tool is mandated when removing Bartack, Box X, or Double Box X stitch formations.

If bartack stitching requires repair, bartacks will be completely removed and a new bartack will be replaced with the same stitch length and width.

END OF TASK**END OF WORK PACKAGE**

FIELD MAINTENANCE

T-11 RESERVE RISER SET
REPAIR, REPLACE**INITIAL SETUP:****Tools**

Crowfoot Attachment, Socket Wrench, 3/8-inch drive,
Open end, 7/16 inch (WP 0102, Item 12)
Needle, Upholsterers, Sizes 3 (WP 0102, Item 31)
Sewing Machine, Light Duty (WP 0102, Item 57)
Wrench, Adjustable, 6-inch (WP 0102, Item 72)
Wrench, Adjustable, 8-inch (WP 0102, Item 73)
Wrench, Torque, 0-300 inch-pounds (WP 0102,
Item 74)

Personnel Required

Parachute Rigger 92R1P (1)

References

WP 0015
WP 0018
WP 0065

Materials/Parts

Tape, Lacing and Tying, Nylon, A-A-52080-B-3
(WP 0101, Item 41)
Thread, Cotton, Ticket 8/4, Orange, A-A-52094 (WP
0101, Item 48)
Thread, Nylon, V-T-295, Type I or II, Size E, FG504
(WP 0101, Item 54)

Equipment Condition

Lay out on packing table or suitable area.

REPAIR

Re-stitching. Re-stitch hook and pile fastener using a light duty sewing machine and size E nylon thread that contrasts the color of the original stitching and material when possible. Re-stitch directly over the original stitch pattern as closely as possible with 7 to 11 stitches per inch. Lock each row of stitching 2 inches at each end.

Repair Reserve Risers

Refer to WP 0065, Replacement of Reserve Riser Hook and Pile Fastener Tape.

END OF TASK

REPLACE**Remove Reserve Risers from the Reserve Canopy****NOTE**

A packing T-bar may be used to assist in routing of apex hook lanyard.

1. Working in a counterclockwise direction, pass the apex hook lanyard (Figure 1, Item 1) through all of the green and white loops (Figure 1, Item 2) at the apex.

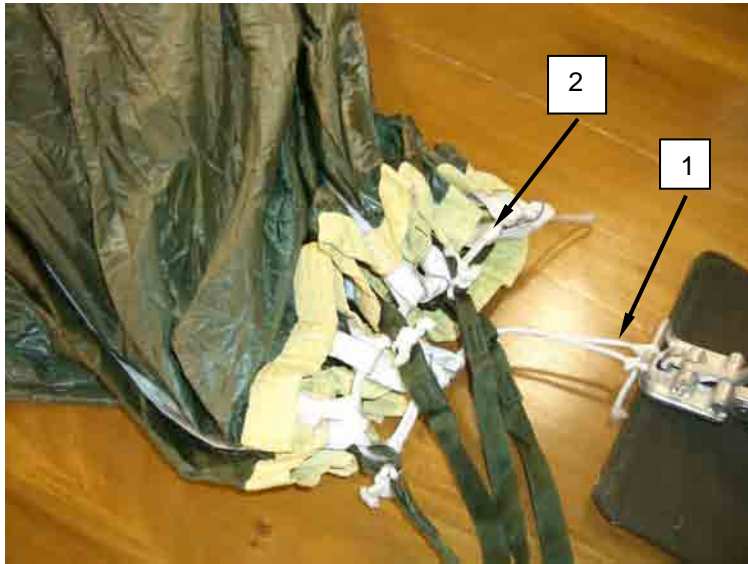

Figure 1. Passing Apex Hook Lanyard through all Apex Loops.

2. Cut a 24-inch length of Ticket, 8/4 cotton thread (orange) (Figure 2, Item 1). Route one end through the loop of the apex hook lanyard (Figure 2, Item 2).
3. Attach running end of the apex hook lanyard to the apex hook (Figure 2, Item 3).

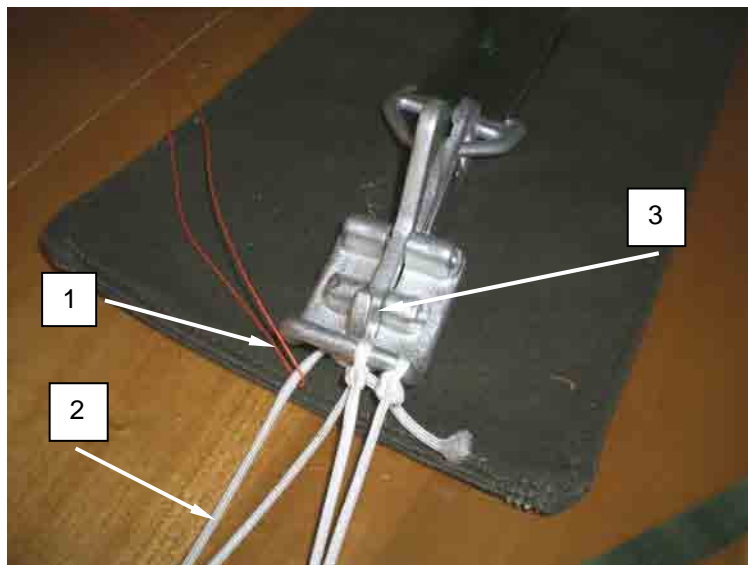

Figure 2. Routing the Ticket 8/4 Cotton Thread through Loop of Apex Hook Lanyard.

REPLACE - CONTINUED

4. Place the reserve pack tray (Figure 3, Item 1) on the pack table with the reserve connector snaps (Figure 3, Item 2) at the lower end of the pack table and the connector links (Figure 3, Item 3) on the tension plate adapter (Figure 3, Item 4). Ensure the gates of the connector snaps are facing downward and the butterfly portions of the connector snaps are facing outward.

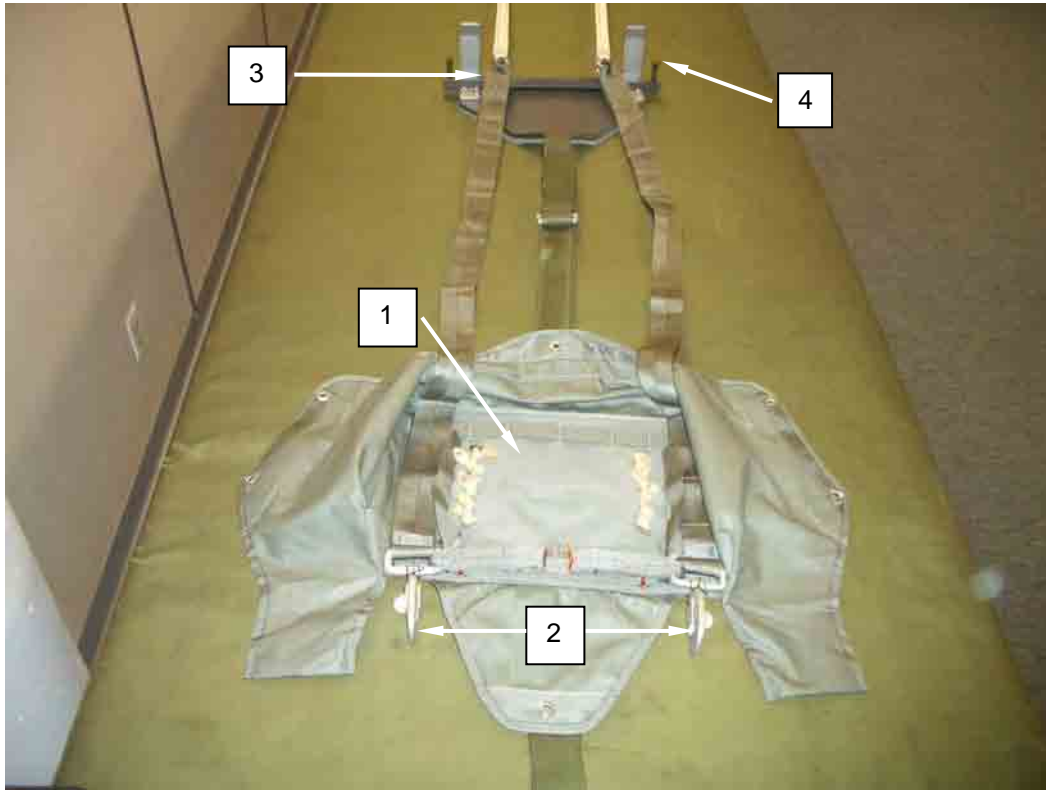

Figure 3. Placing Connector Links on Tension Plate Adapter.

5. Remove reserve risers from the riser stowbars.
6. Pull risers from the pack tray releasing risers from the hook pile tape fastener.

END OF TASK

REPLACE - CONTINUED**Replace Connector Links**

1. Cut and remove tacking (Figure 4, Item 1) from risers (Figure 4, Item 2).

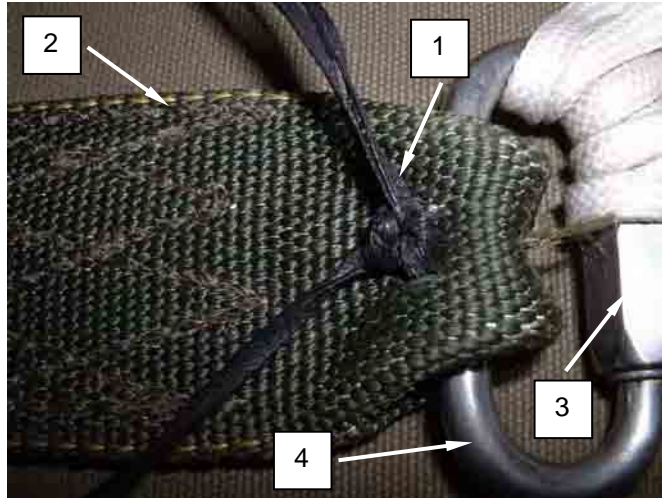

Figure 4. Remove Tacking.

2. Using an 8-inch adjustable wrench, completely open barrel nuts (Figure 4, Item 3) on each connector link (Figure 4, Item 4).
3. Rotate each connector link (Figure 4, Item 4) sideways on the short portion.
4. Remove reserve risers.
5. Remove suspension lines sequentially and transfer to an appropriate tool.
6. Discard connector link and obtain new connector link from stock.
7. Position replacement connector links with nylon patch so that barrels face inboard and tighten downward to lower end of table.
8. Transfer suspension lines sequentially from tool to connector link.
9. Finger tighten connector link.
10. Repeat steps 5 through 9 for other connector link.

REPLACE - CONTINUED**NOTE**

Connector link barrel nuts must be oriented so they face inboard and tighten downward.

Suspension lines 1 through 20 are divided into two groups, number 1 through 10 in the left group and number 11 through 20 in the right group.

11. Place the left set of connector links (Figure 5, Item 1) on the left post (Figure 5, Item 2) of the tension plate adapter and the right set of connector links (Figure 5, Item 3) on the right post (Figure 5, Item 4) of the tension plate adapter.

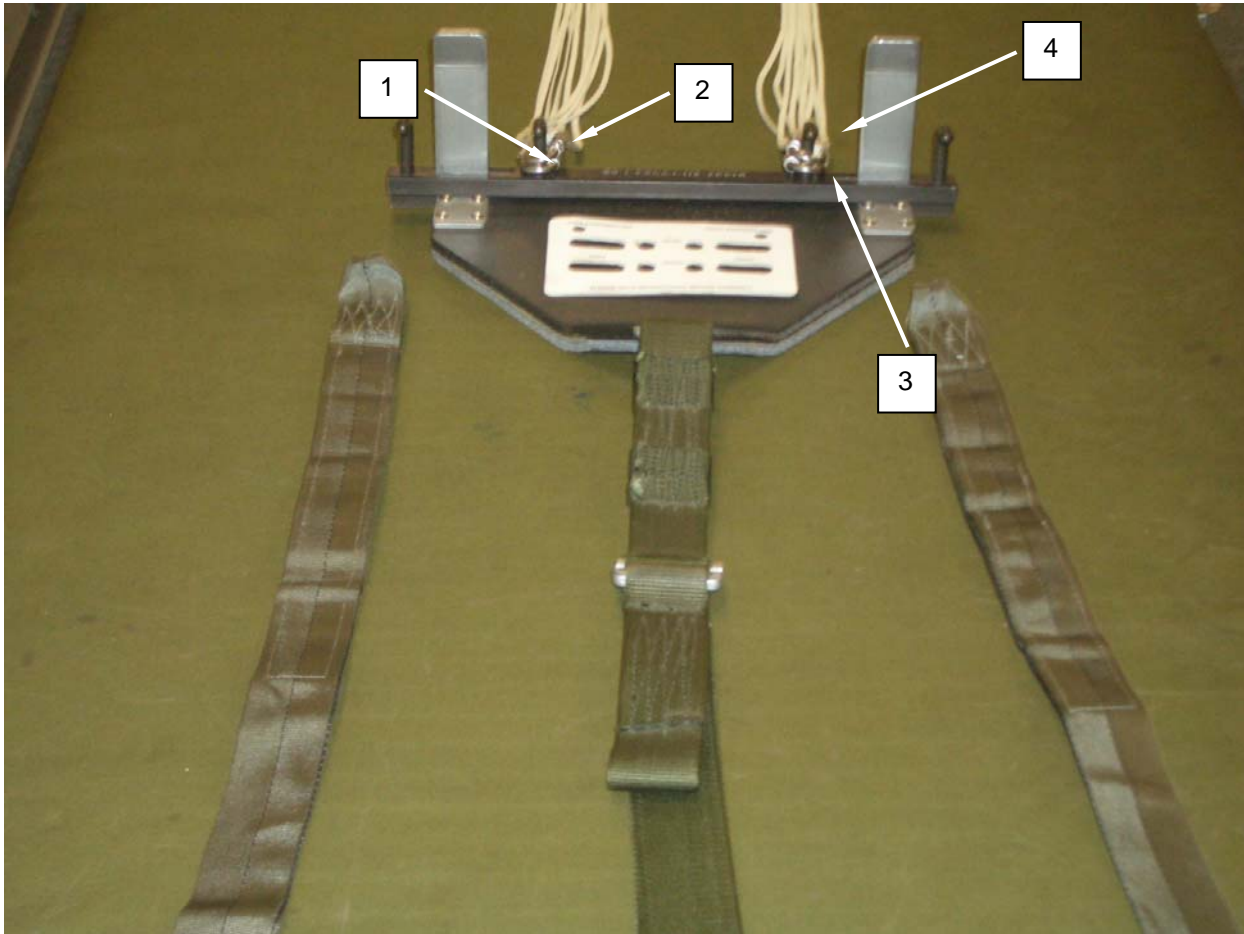

Figure 5. Riser Connector Links.

REPLACE - CONTINUED

NOTE

Two personnel are required for a line continuity check. The first person will be at the connector links to ensure lines are properly located on connector links. The second person will be at the lower lateral band calling off properly sequenced suspension lines.

12. Conduct a continuity check in accordance with Figure 6 below.
13. Top left suspension line group. Line 1 (inside top) followed in sequence by 2, 3, 4, 5 (outside top) runs from the canopy, to the top left connector link.
14. Bottom left suspension line group. Line 6 (outside bottom) followed in sequence by 7, 8, 9, 10 (inside bottom) runs from the canopy, to the bottom left connector link.
15. Bottom right suspension line group. Line 11 (inside bottom) followed in sequence by 12, 13, 14, 15 (outside bottom) runs from the canopy, to the bottom right connector link.
16. Top right suspension line group. Line 16 (outside top) followed in sequence by 17, 18, 19, 20 (inside top) runs from the canopy, to the top right connector link.

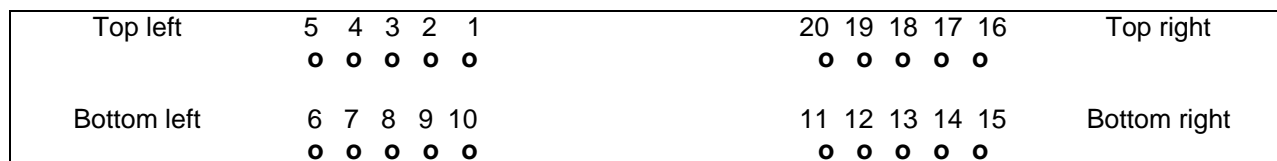

Figure 6. Suspension Line Groups.

17. Loosely connect connector links to appropriate riser.
18. Perform a four line check IAW "Perform a Four Line Check" in WP 0015.

REPLACE – CONTINUED

CAUTION

Do not use vise grips or other type pliers to hold connector link body when tightening, as damage to connector link can occur.

NOTE

Ensure torque wrench is calibrated by TMDE office prior to use.

19. Using a torque wrench with crowfoot adapter, tighten barrel nut (Figure 7, Item 1) on connector link (Figure 7, Item 2) to 50 inch-pounds.

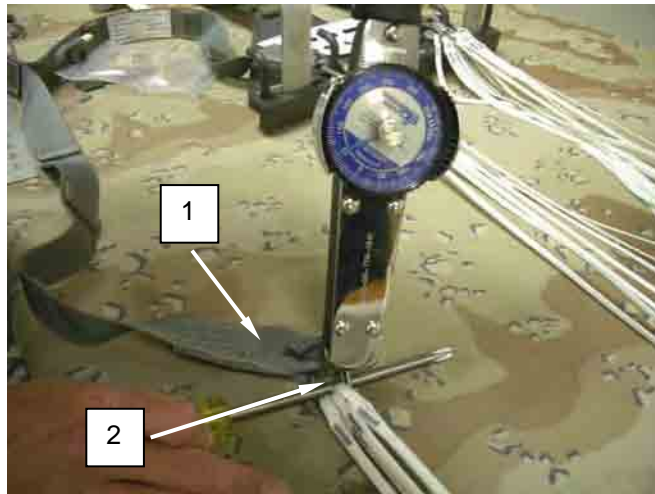

Figure 7. Tighten Barrel Nut on Connector Link.

20. Remove connector links and risers from the tension plate adapter.
21. Rotate the riser (Figure 8, Item 1) sideways on the long portion of the connector link (Figure 8, Item 3) positioning the riser to the long portion of the connector link opposite the barrel nut.
22. Tack each riser (Figure 8, Item 1) with a 12-inch length of lacing and tying tape, one turn double (Figure 8, Item 4). Pass the upholsterer's needle (Figure 8, Item 5) tight against the body of the connector link (Figure 8, Item 3) with running ends toward top when finished.

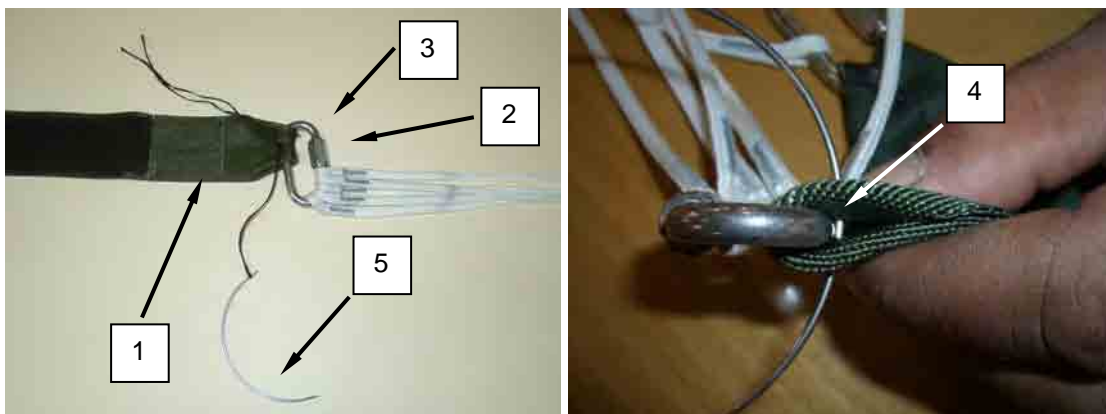

Figure 8. Tack Riser with Lacing and Tying Tape.

REPLACE - CONTINUED

23. Secure with a surgeon's knot locking knot, ensuring the knot is toward the top. Trim the running ends to $\frac{1}{2}$ inch.
24. Rotate the connector link (Figure 9, Item 1) back in place.

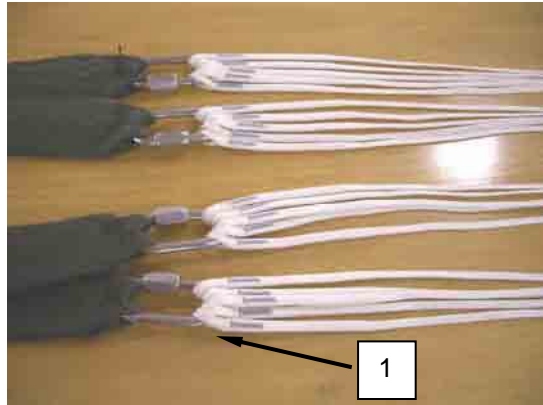

Figure 9. Rotating Risers to Lower Portion of Connector Link.

25. Mark new place-in-service date on data label IAW WP 0018.

END OF TASK

END OF WORK PACKAGE

FIELD MAINTENANCE

**RESERVE RISER HOOK AND LOOP FASTENER TAPE
RESERVE PACK TRAY HOOK FASTENER
REPAIR, REPLACE**

INITIAL SETUP:**Tools**

Heated Blade Cutter (WP 0102, Item 18)
Sewing Machine, Light Duty (WP 0102, Item 57)
Shears, Tailors, 12 inch (WP 0102, Item 61)
Tape, Measuring (WP 0102, Item 65)

Personnel Required

Parachute Rigger 92R1P (1)

Materials/Parts

Fastener Tape, Hook, 1-1/2-inch wide, A-A-55126, TY II, Class 1, FG504 (WP 0101, Item 22)
Fastener Tape, Pile, 1-1/2-inch wide, A-A-55126, TY II, Class1, FG504 (WP 0101, Item 23)
Thread, Nylon, V-T-295, Type I or II, Size E, FG504 (WP 0101, Item 54)

Equipment Condition

Lay out on packing table or other suitable area.

REPAIR**NOTE**

During repair, ensure that the elastic riser stow bar is not sewn over.

Re-stitching

Re-stitch hook and pile fastener using a light duty sewing machine and size E nylon thread that contrasts the color of the original stitching and material when possible. Re-stitch directly over the original stitch pattern as closely as possible with 7 to 11 stitches per inch. Lock each row of stitching ½ inch if possible at each end.

Repair broken stitching by using size E nylon thread over the original stitching.

END OF TASK

REPLACE**Replace Hook and Pile****NOTE**

Damaged hook and pile tapes must be replaced in complete lengths.

1. Remove hook or pile fastener tape by removing stitching. Remove or lay aside items that may interfere with the replacement process.
2. Cut a new length of hook or pile tape IAW Table 1.

Table 1. Hook and Pile Fastener Material.

COMPONENT	MATERIAL	LENGTH
Reserve Riser Loop Fastener	WP 0092, Item 2	10 ⁵ / ₈ inches
Reserve Riser Hook Fastener	WP 0092, Item 4	15 inches
Reserve Riser Loop Fastener	WP 0092, Item 3	15 inches
Reserve Pack Tray Hook Fastener	WP 0093, Item 5	11 ¼ inches

3. Sew in place with a light-duty sewing machine, size E nylon thread and 7 to 11 stitches per inch using original stitch pattern.

END OF TASK

END OF WORK PACKAGE

FIELD MAINTENANCE

T-11 RESERVE PACK TRAY ASSEMBLY
REPAIR, REPLACE**INITIAL SETUP:****Tools**

Sewing Machine, Bartack, Industrial (WP 0102, Item 50)
 Sewing Machine, Darning (WP 0102, Item 52)
 Sewing Machine, Light Duty (WP 0102, Item 57)
 Wrench, Adjustable, 8-inch (WP 0102, Item 73)

Personnel Required

Parachute Rigger 92R1P (1)

References

WP 0016

Materials/Parts

Cord, Fibrous, Nylon, MIL-C-5040H, Red, Type III (WP 0101, Item 15)
 Thread, Cotton, Ticket 8/4, Orange, A-A-52094 (WP 0101, Item 48)
 Thread, Nylon, V-T-295, Type I or II, Size E, FG504 (WP 0101, Item 54)

Equipment Condition

Lay out on packing table or other suitable area.

REPAIR**Re-stitch the Reserve Pack Tray**

Re-stitch reserve pack tray using the appropriate sewing machine and thread that contrasts the color of the original stitching and material when possible. Re-stitch directly over the original stitch pattern as closely as possible with the appropriate stitches per inch. Lock each row of straight stitching 2 inches at each end.

If bartack stitching requires repair, bartacks will be completely removed and a new bartack will be replaced with the same stitch length and width.

END OF TASK**Darning the Reserve Pack Tray**

1. A maximum of two darns per flap/panel is authorized.
2. Darning repairs may not be closer than 4 inches from each other.
3. Darn a hole or tear that does not exceed $\frac{3}{4}$ inch in length or diameter.
4. Refer to WP 0016 for darning procedures.

END OF TASK**Repair the Reserve Pack Tray**

1. Small holes that are too large for darns can be patched using basic patching procedures as stated in WP 0016.
2. All patches are to be applied to the outside of the pack tray.

END OF TASK

REPLACE**Remove Reserve Pack Tray from Reserve Canopy Risers**

1. Pull risers (Figure 1, Item 1) from pack tray (Figure 1, Item 2).
2. If necessary, cut lacing and tying tape on connector snaps (Figure 1, Item 3).
3. If necessary, cut the spreader bar attaching ties (Figure 1, Item 4).
4. Remove ticket 8/4 cotton thread (orange).
5. Remove and discard damaged reserve pack tray (Figure 1, Item 2).

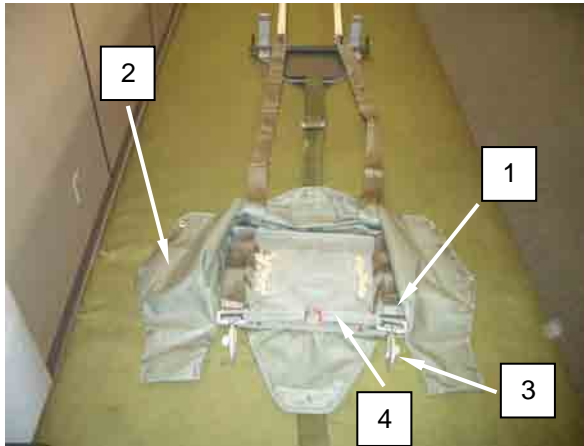

Figure 1. Remove Reserve Pack Tray from Reserve Canopy Risers.

END OF TASK

REPLACE – CONTINUED**Secure Spreader Bar to New Pack Tray****NOTE**

Position pack tray on the packing table between tension plate and the lower end of the pack table. Orient the carry handle of the pack tray to the lower end of the packing table.

1. Place the pack tray under the risers with the connector snaps located at the carrying handle.
2. Place the pile tape on the riser to the hook tape on the pack tray. Ensure that the top bar (Figure 2, Item 1) of each snap hook aligns with the top of the binding tape (Figure 2, Item 2). S-fold the excess of the spreader bar (Figure 2, Item 3) back onto itself.

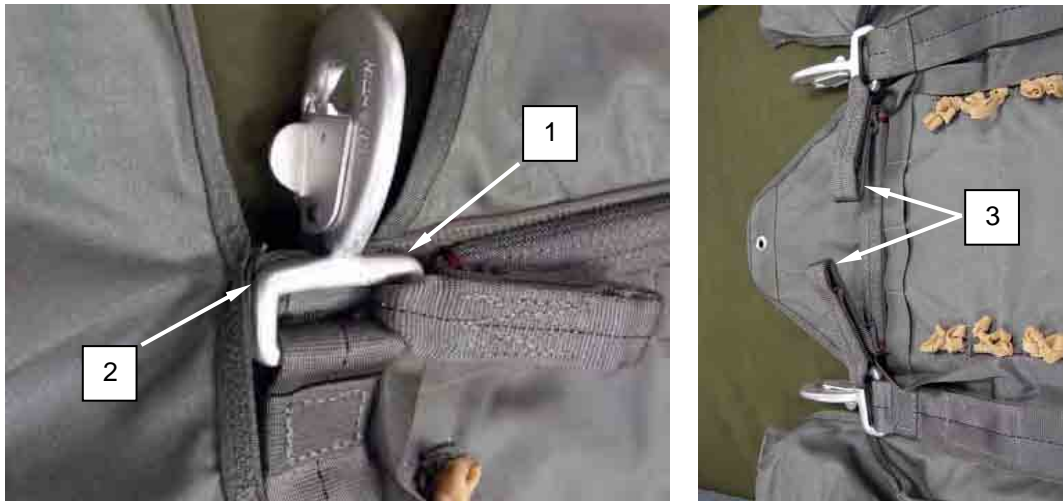

Figure 2. Aligning Top Bar of Snap Hook with Binding Tape and S-Folding Excess Spreader Bar.

REPLACE – CONTINUED

3. Use an upholstery needle with a 24-inch piece of lacing and tying tape, one turn single, to attach the connector snap to the pack tray. Push the tacking needle just below the binding tape, through the back of the pack tray, to the front in the middle of the connector snap (Figure 3).



Figure 3. Securing Connector Snaps To Pack Tray.

4. Route the lacing tape around the throat of the connector snap.
5. Run the tacking needle through the front of the pack tray to the back of the pack tray.
6. Both running ends should now be on the back side of the pack tray.
7. Route the running ends over the pack tray around the throat of the connector snap, and tie a surgeon's knot locking knot. Trim the running ends to 1 inch.
8. Repeat for the second connector snap.

REPLACE – CONTINUED

9. Using an 8-inch piece of ticket 8/4 cotton thread (orange), route from the right side to the left side in a counter-clockwise direction between the plies of the excess fold-over from the spreader bar and back through the right side (Figure 4).
10. Tie a surgeon's knot locking knot. Loop should be approximately 2½- to 3-inches long. Ensure tie is secured tightly.

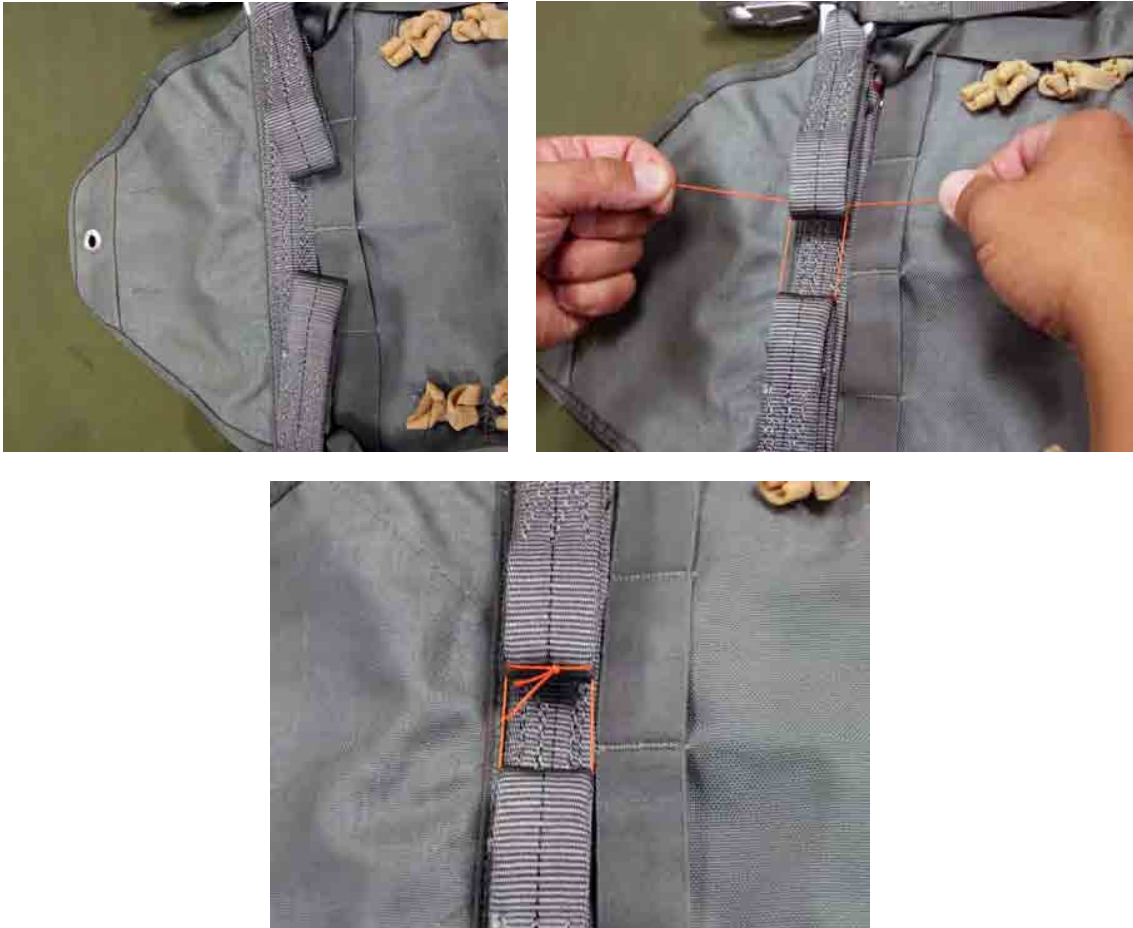

Figure 4. Securing the Excess Spreader Bar Fold-over.

END OF TASK

END OF WORK PACKAGE

FIELD MAINTENANCE**RESERVE PACK TRAY EDGE BINDING
REPAIR**

INITIAL SETUP:**Tools**

Sewing Machine, Light Duty (WP 0102, Item 57)
Shears, Tailors, 12 inch (WP 0102, Item 61)
Tape, Measuring (WP 0102, Item 65)

Personnel Required

Parachute Rigger 92R1P (1)

Materials/Parts

Tape, Nylon, MIL-T-5038, Type III, Class 1, 3/4-
inch Wide, FG504 (WP 0101, Item 43)
Thread, Nylon, V-T-295, Type I or II, Size E,
FG504 (WP 0101, Item 54)

Equipment Condition

Lay out on packing table or other suitable area.

REPAIR**Re-stitching**

Re-stitch edge binding using a light duty sewing machine and size E nylon thread that contrasts the color of the original stitching and material when possible. Re-stitch directly over the original stitch pattern as closely as possible with 7 to 11 stitches per inch. Lock each row of stitching by backstitching at least ½ inch.

Splicing

Splice an edge binding (an unlimited number of times) as follows:

1. Cut a length of ¾-inch wide nylon tape 2 inches longer than damaged area.
2. Make a ½-inch fold under on each end of tape length.
3. Center and fold tape lengthwise over edge of the damaged area. Secure splice by stitching (a box stitch formation, 1/16-inch in from each edge, along full length of splice material.) Replace with two rows of stitching overlapping the original stitching 1 inch past the splice creating a locking stitch on both ends.

END OF TASK**END OF WORK PACKAGE**

FIELD MAINTENANCE**RESERVE PACK TRAY METALLIC GROMMETS
REPAIR, REPLACE**

INITIAL SETUP:**Tools**

File, Hand, Flat (WP 0102, Item 16)
Heated Blade Cutter (WP 0102, Item 18)
Mallet, Rawhide (WP 0102, Item 29)
Pliers, Diagonal Cutting (WP 0102, Item 38)
Punch and Die, Grommet Inserting, Size 0
(WP 0102, Item 43)
Sewing Machine, Medium Duty (WP 0102,
Item 59)
Shears, Tailors, 12 inch (WP 0102, Item 61)

Personnel Required

Parachute Rigger 92R1P (1)

Equipment Condition

Lay out on packing table or other suitable area.

Materials/Parts

Cloth, Abrasive (WP 0101, Item 10)
Thread, Nylon, V-T-295 Type I or II, Size E,
FG504 (WP 0101, Item 54)
Webbing, Nylon, MIL-W-4088, Type II 1-inch
Wide, FG504 (WP 0101, Item 59)

REPAIR

Repair reserve pack tray grommets size #0 (Figure 1, Item 1) as follows:

1. Remove burrs, rough spots, rust, or corrosion from an installed grommet by filing with a file or by buffing with crocus cloth.
2. Reseat a loose grommet

NOTE

Reinforcement is allowed only on the left and right closing flaps of the reserve parachute container.

3. If fabric area around original grommet has been damaged, repair area by applying a reinforcement patch to outside of flap. Use a 1-inch square of seared type II nylon webbing.

END OF TASK**REPLACE****Remove Original Grommet**

1. Using suitable type tool, lift edge of original washer at one point.
2. Grip lifted washer edge with diagonal cutters and roll washer edge back to lift washer from original grommet. Remove original grommet from material.

END OF TASK

REPLACE - CONTINUED**Install New Grommet**

1. Insert barrel of replacement grommet through accommodating hole in material and ensure grommet flange is located on same side of material as original grommet.
2. Position grommet on die with barrel facing up and place washer over grommet barrel. Ensure grommet barrel and washer are aligned to prevent off-center setting of grommet.
3. Using a punch and rawhide mallet or other non-steel impact device, spread grommet barrel by hammering until barrel collar is rolled down smooth on washer. If grommet barrel splits during hammering, remove and replace installed grommet with a serviceable item from stock.

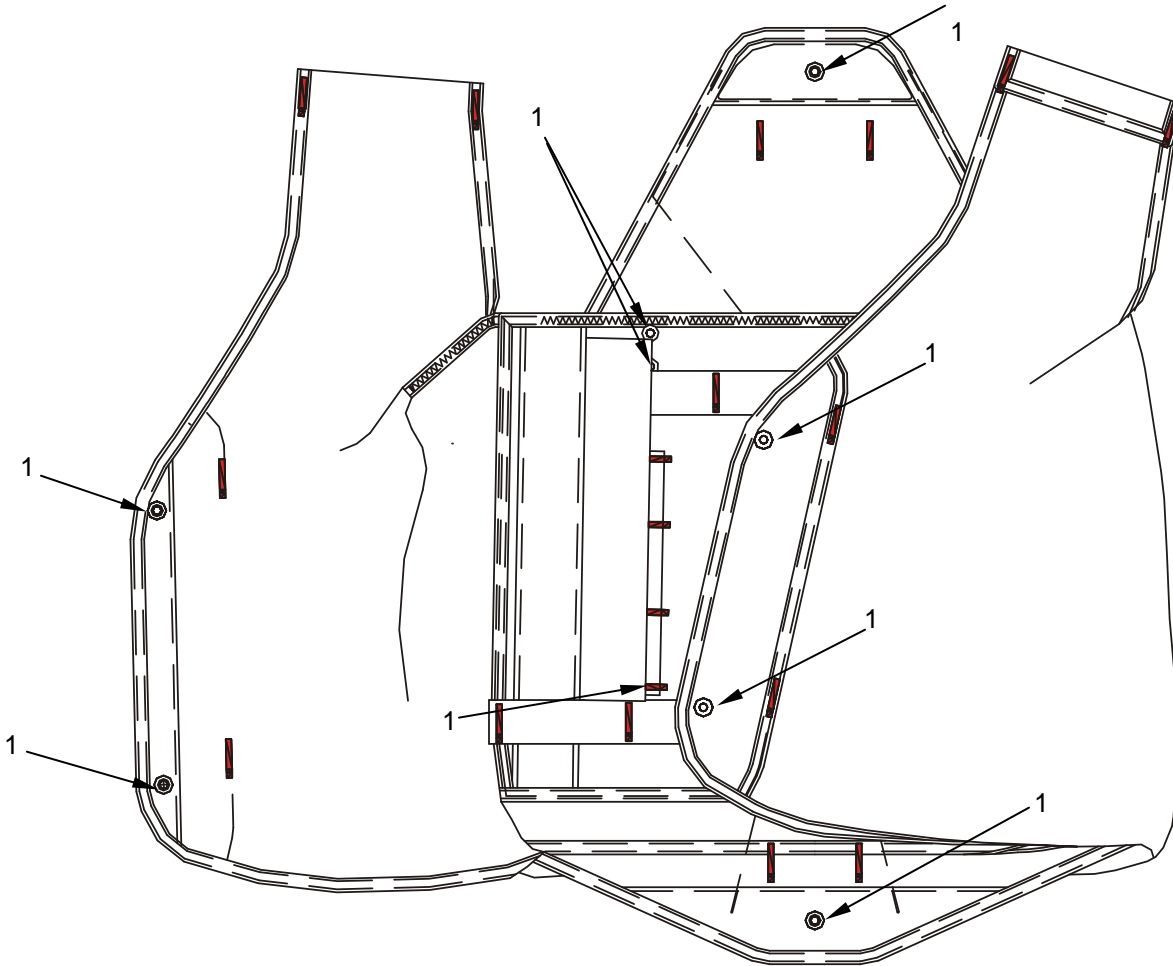

Figure 1. Reserve Pack Tray Grommet Size #0.

END OF TASK

END OF WORK PACKAGE

FIELD MAINTENANCE

RESERVE PACK TRAY ELASTIC RISER STOW BARS
REPAIR, REPLACE**INITIAL SETUP:****Tools**

Sewing Machine, Bartack, Industrial (WP 0102, Item 50)
 Sewing Machine, Medium Duty (WP 0102, Item 59)
 Shears, Tailors, 12 inch (WP 0102, Item 61)
 Stitch Removal Tool (WP 0102, Item 64)
 Tape, Measuring (WP 0102, Item 65)

Personnel Required

Parachute Rigger 92R1P (1)

Materials/Parts

Pencil, Marking, China, White, A-A-87 (WP 0101, Item 31)
 Thread, Nylon, V-T-295, Type I or II, Size E, FG504 (WP 0101, Item 54)
 Webbing, Elastic, Type I, Class I, 1 inch Wide, FG504 (WP 0101, Item 57)

Equipment Condition

Lay out on packing table or other suitable area.

REPAIR**NOTE**

For a center stitch repair, ensure that the log record book is not sewn over pin pocket (back). If any of the bartacks are damaged, or if the inner stow bars are damaged, sew to outside of log record book pocket.

1. Remove broken stitching/threads.
2. Using a bartack sewing machine, size E nylon thread, place a $\frac{1}{8}$ - x $\frac{7}{8}$ -inch, 42-stitch bartack sew elastic riser bar in original stitch location.

END OF TASK**REPLACE****Replace Upper Elastic Riser Stow Bar**

1. Mark location of Army Parachute Log Record pocket. Carefully remove the Army Parachute Log Record pocket from the pack tray.

REPLACE - CONTINUED

2. Rotate the pack tray (Figure 1, Item 1) and mark location of the bartacks (Figure 1, Item 2) for the elastic riser stow loops (Figure 1, Item 3).
3. Using an appropriate tool, remove the damaged elastic riser stow bar.



Figure 1. Remove Damaged Elastic Riser Stow Bar.

4. Cut an 11½-inch length of elastic webbing and mark the center.
5. Align center mark of elastic with the center mark of the elastic riser stow bar. Using a bartack sewing machine and size E nylon thread, secure the elastic to the pack tray at center mark with a $\frac{1}{8}$ - x $\frac{7}{8}$ -inch, 42-stitch bartack.

CAUTION

Do not sew through the elastic.

6. Rotate the pack tray and reposition the Army Parachute Log Record pocket to its original position. Using a medium duty sewing machine and size E nylon thread, 7 to 11 stitches per inch, sew in place as per original stitching.

NOTE

Once the elastic riser stow bar has been replaced, the bartacks will show through the pack tray.

7. Rotate the pack tray and place a $\frac{1}{8}$ - x $\frac{7}{8}$ -inch, 42-stitch bartack at each marked location of the elastic riser stow bar. Fold the end under $\frac{1}{2}$ inch before bartacking.

END OF TASK

REPLACE - CONTINUED**Replace Lower Elastic Riser Stow Bar**

1. Using an appropriate tool, carefully remove the stitching securing the inner panel to the pack tray (Figure 2, Item 1) enough to where you can access the lower elastic riser stow bar (Figure 2, Item 2). (Approximately 4 inches up each side and across the entire bottom).



Figure 2. Replace Lower Elastic Riser Stow Bar.

2. Remove the three sets of stitches securing the internal frame to the pack tray.
3. Mark location of the bartacks (Figure 2, Item 3) for the elastic riser stow bar. Remove the damaged elastic riser stow bar.
4. Cut a 15½-inch length of elastic webbing. Fold one edge under ½ inch and place a 1/8- x 7/8-inch, 42-stitch bartack on the outside mark on the inner panel with size E nylon thread. The running end should lie across the pack tray.
5. Using a bartack sewing machine with size E nylon thread, place a 1/8- x 7/8-inch, 42-stitch bartack on the elastic riser stow bar at marks folding the opposite end under ½ inch. (Once the elastic riser stow bar has been replaced the bartacks will show through the pack tray).
6. Resew the inner panel to the pack tray using a medium duty sewing machine and size E nylon thread, 7 to 11 stitches per inch.
7. Resew the three sets of stitching securing the internal frame in place with three rows of straight stitch using size E nylon thread, 7 to 11 stitches per inch.

END OF TASK

END OF WORK PACKAGE

FIELD MAINTENANCE

RESERVE PACK TRAY WAISTBAND RETAINER
REPAIR, REPLACE**INITIAL SETUP:****Tools**

Heated Blade Cutter (WP 0102, Item 18)
Sewing Machine, Bartack, Industrial (WP 0102, Item 50)
Shears, Tailors, 12 inch (WP 0102, Item 61)
Stitch Removal Tool (WP 0102, Item 64)
Tape, Measuring (WP 0102, Item 65)

Personnel Required

Parachute Rigger 92R1P (1)

Materials/Parts

Thread, Nylon, V-T-295, Type I, II, Size E, FG504 (WP 0104, Item 54)
Webbing, Nylon, Type VIII, 1 23/32-inch Wide, FG504 (WP 0104, Item 66)

Equipment Condition

Lay out on packing table or other suitable area.

REPAIR**NOTE**

During repair, ensure that the elastic riser stow bar is not sewn over.

1. Remove broken stitching threads.
2. Using a bartack sewing machine, size E nylon thread, place a $\frac{1}{8}$ - x $\frac{7}{8}$ -inch, 42-stich bartack on the waistband loop in the original stitch position.

END OF TASK**REPLACE****Replace Waistband Retainer**

1. Remove damaged waistband retainer (Figure 1, Item 1).
2. Using a hot knife cut a 3½-inch length of Type VIII nylon webbing.
3. Place the new waistband retainer over the area where the damaged waistband retainer was removed.
4. Using a bartack sewing machine size E nylon thread, place a $\frac{1}{8}$ - x $\frac{7}{8}$ -inch, 42-stich bartack on the waistband retainer at same location as original. Ensure no stitches are placed into the elastic riser stow bar loop.
5. Stitch over the suspension line stow loop bartack. Bartacks will show through the pack tray once replaced.

REPLACE - CONTINUED

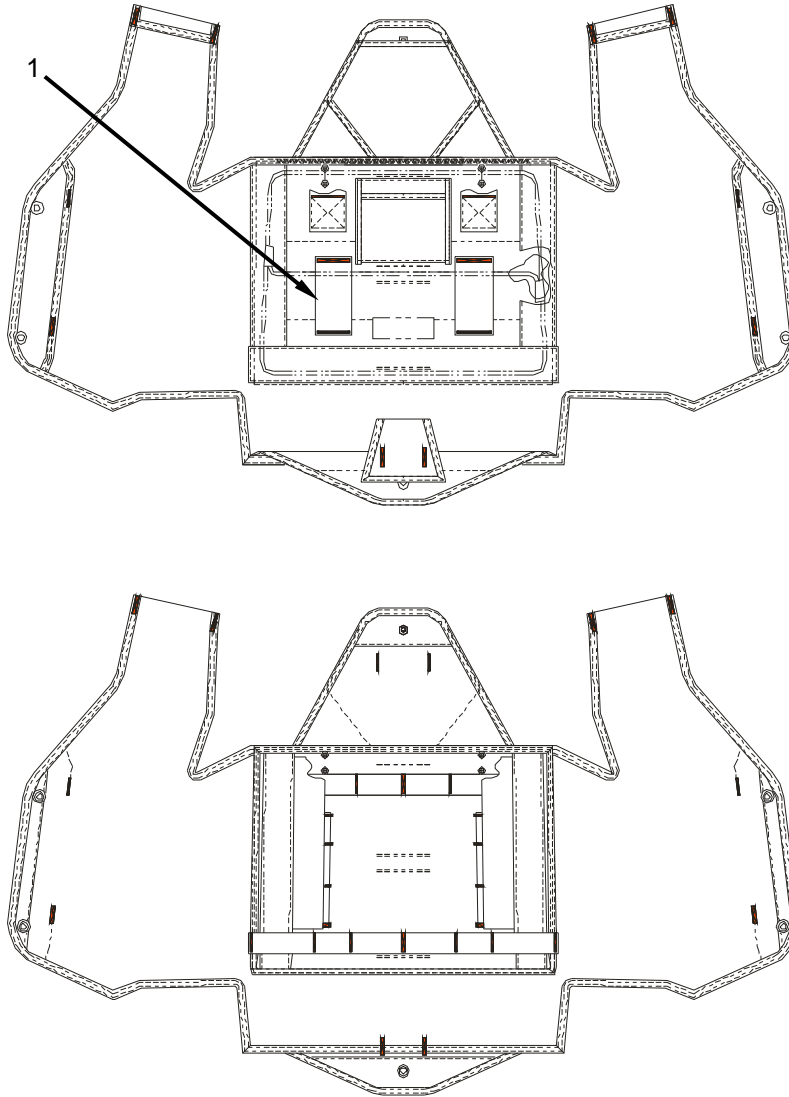

Figure 1. Reserve Pack Tray Waistband Retainers.

END OF TASK

END OF WORK PACKAGE

FIELD MAINTENANCE

T-11 RESERVE TOP AND BOTTOM STIFFENERS
REPLACE**INITIAL SETUP:****Tools**

Sewing Machine, Medium Duty (WP 0102, Item 59)
 Shears, Tailors, 12 inch (WP 0102, Item 61)
 Stitch Removal Tool (WP 0102, Item 64)

Personnel Required

Parachute Rigger 92R1P (1)

Materials/Parts

Tape, Nylon, MIL-T-5038 Type III, 3/4-inch Wide, FG504 (WP 0101, Item 43)
 Thread, Nylon, V-T-295, Type I or II, Size E, FG504 (WP 0101, Item 54)
 Webbing, Nylon, MIL-W-4088, Type XII, 1 1/32-inch Wide, FG504 (WP 0101, Item 60)
 Webbing, Nylon, Type VIII, 1-23/32 inch FG504 (WP 0101, Item 66)

References

WP 0068

Equipment Condition

Lay out on packing table or other suitable area.

REPLACE**Replace Stiffener****NOTE**

Reinforcement is allowed on the left and right closing flaps of the reserve parachute container only.

1. Remove grommet IAW WP 0068.
2. Remove stitching from the exposed side of the type XVII nylon webbing (Figure 1) to remove the stiffener.



Figure 1. Remove Stitching Bordering the Stiffener.

REPLACE - CONTINUED

3. Insert a new stiffener (Figure 2, Item 1). Using a medium duty sewing machine and size E nylon thread, 7 to 11 stitches per inch, close the open side of the type XVII nylon webbing locking the stitching along the binding tape.



Figure 2. Insert a New Stiffener.

4. If fabric area around original grommet has been damaged, repair area by applying a reinforcement patch to outside of flap. Use a 1-inch square of seared type II nylon webbing.
5. Install grommets IAW WP 0068.

END OF TASK

END OF WORK PACKAGE

FIELD MAINTENANCE

T-11 RESERVE RIPCORD ASSEMBLY
REPLACE, TEST**INITIAL SETUP:****Tools and Special Tools**

None required.

Personnel Required

Parachute Rigger 92R1P (1)

Materials/Parts

Cuff Pull Handle Reserve Ripcord (fabricated IAW WP 0084, Illustrated List of Manufactured Items)
Thread, Nylon, V-T-295, Type I or II, Size E, FG504 (WP 0101, Item 54)

References

DA Form 3912
SF 368
WP 0015
WP 0018
WP 0084

Equipment Condition

Unpacked

REPLACE**Replace Ripcord Handle****WARNING**

Placement of reserve ripcord assembly will require a repack of the T11R.

1. Remove reserve ripcord assembly.
2. Replace with a new reserve ripcord assembly grip from stock. Mark new placed-in-service date IAW WP 00018.
3. Pack IAW WP 0015.

END OF TASK

TEST**Conduct a 27-Pound Maximum Ripcord Pull Test as Follows:****WARNING**

Do not stand directly underneath the T-11 Reserve, in the event of accidental activation. Being hit by the ejector spring may cause severe injury. Stand off to one side of the T-11 Reserve when conducting both the 14-pound and 27-pound pull test.

WARNING

Do not stand directly underneath the T-11 Reserve, in the event of accidental activation. Being hit by the ejector spring may cause severe injury. Stand off to one side of the T-11 Reserve when conducting the 27-pound pull test.

NOTE

Use of a locally fabricated handle cuff is required. Fabricate a fabric cuff IAW WP 0084 entitled "Illustrated List of Manufactured Items".

A suggested method to ensure sufficient clearance beneath the horizontally suspended T-11 Reserve to conduct this test is to place two pack tables end to end with approximately 18 inches between them. Place the reserve parachute on top of the pack table centered over the gap. If available, a packing cradle may be used.

To conduct the T-11 Reserve ripcord pull tests, the packed T-11 Reserve shall be face down on the top of the packing cradle to allow the parachute to be deployed in a downward direction. There must be sufficient clearance beneath the horizontally suspended T-11 Reserve to suspend a weight from the ripcord handle and allow it to withdraw the ripcord pins from the soft loops activating the parachute.

The pull force exerted upon the handle must be uniformly distributed along the length of the handle. The handle cuff may be fabricated by using lightweight cotton duck material cut to 4 inches by 6 inches in size with two ½-inch holes spaced evenly so they will be below the handle when the material is folded in half around the handle.

1. Place the handle cuff over the T-11 Reserve ripcord handle so that the grommets are below the handle and centered.
2. While standing at the pack table with the T-11 Reserve positioned for the pull test, carefully attach a 27-pound weight to the ripcord grip and very slowly remove your hands from under the weight to allow the weight to be very slowly transferred to the ripcord grip. Do not release the weight suddenly or let it drop since this will invalidate the test.
3. If the 27-pound weight does not withdraw the ripcord pins and handle, remove the weight and re-inspect the ripcord pins and ripcord handle to ensure there are no bent pins. Ensure proper alignment of the handle tuck tabs. Bent pins or misaligned tuck tabs can significantly increase the ripcord withdrawal force. If ripcord pins and handle are serviceable, reseal the pins and tuck tabs and conduct a retest.
4. The retest must be performed five times. Conduct retest by repacking the T-11 Reserve IAW WP 0015 and repeat step 1.

TEST - CONTINUED

5. Upon completion of the retest (five iterations), if the 27-pound weight does withdraw the ripcord pins and ripcord handle each of the five times, it passes the test.
6. If, during any one of the five retest iterations, the 27-pound weight does not withdrawal the ripcord pins and ripcord handle, then remove the T-11 Reserve assembly, replacement pack tray or ripcord handle (which ever is applicable), from service and follow instructions in step 7 below.
7. If the pack tray and ripcord handle are new (part of a T-11 Reserve assembly), or a new replacement pack tray or handle, submit a PQDR for the new item.
8. If the T-11 Reserve passes both the 14 and 27 pound ripcord pull test, repack the T-11 Reserve IAW WP 0015.
9. Annotate completion of this test (i.e. test conducted, name of tester, date completed) on the notes page of the parachute log record book (DA Form 3912).

END OF TASK**END OF WORK PACKAGE**

FIELD MAINTENANCE
MAIN DEPLOYMENT BAG
REPAIR

INITIAL SETUP:**Tools and Special Tools**

Sewing Machine, Light Duty (WP 0102, Item 57)
Scissors, 8 Inch (WP 0102, Item 48)

Personnel Required

Parachute Rigger 92R1P (1)

Materials/Parts

Thread, Nylon, V-T-295, Type I or II, Size E, FG504 (WP 0106, Item 54)
Pencil, China Marker, Yellow, A-A-87 (WP 0101, Item 30)

References

WP 0016
WP 0018
WP 0074 through WP 0077

Equipment Condition

Unpacked

REPAIR

Re-stitching. Stitch and re-stitch with size E nylon thread that's contrasting in color of the original stitching, when possible. Lock all straight stitching by backstitching at least ½ inch. Re-stitch directly over the original stitching; follow the original stitch pattern as closely as possible.

Re-stenciling. If necessary, re-stencil the bag number on the suspension line protector cover in accordance with WP 0018.

Darn Main Deployment Bag

Darning will be accomplished IAW WP 0016.

Repair Deployment Bag

Refer to individual repair procedures in WP 0074 through WP 0077.

END OF TASK**END OF WORK PACKAGE**

FIELD MAINTENANCE

T-11 MAIN BAG STOW BAR ASSEMBLY
REPAIR, REPLACE**INITIAL SETUP:****Tools and Special Tools**

Ruler, Tab, Metal 16 Inches (WP 0102, Item 46)
 Sewing Machine, Bartack, Industrial (WP 0102, Item 50)
 Sewing Machine, Medium Duty (WP 0102, Item 59)
 Shears, Tailors, 12 inch (WP 0102, Item 61)
 Stitch Removal Tool (WP 0102, Item 64)

Personnel Required

Parachute Rigger 92R1P (1)

Equipment Condition

Unpacked

Materials/Parts

Pencil, China Marker, Yellow, A-A-87 (WP 0101, Item 30)
 Thread, Nylon, V-T-295, Type I or II, Size E, FG504 (WP 0101, Item 54)
 Thread, Nylon, V-T-295, Type I, II or III, Class A, Size FF, Color FG504 (WP 0101, Item 69)

REPAIR**Repair Limitations**

1. Two stow loops per panel may be torn, if the tear does not exceed half the width of the stow loop, and the torn stow loops are not adjoining.
2. If 50% of stitching is loose or broken on one stow loop, re-stitch the stow loop to the stow loop panel. If stitching in more than one adjacent stow loop is broken more than $\frac{3}{4}$ inch in either stow, then re-stitch all stow loops on that side. Use a medium-duty sewing machine, size E, nylon thread, and 7 to 11 stitches per inch.
3. Stow loops that are torn more than half way through may be stitched down (making them unusable), provided a minimum of seven stow loops per stow panel remain as follows:

Re-stitching

1. Lay out on packing table or other suitable area.

REPAIR-CONTINUED

2. Mark $\frac{1}{4}$ inch on one side from the stitching on the damaged stow loop (Figure 1).



Figure 1. Mark Damaged Stow Loop.

3. Measure and mark $\frac{3}{4}$ inch from the stitching on the opposite side of the stow loop (Figure 2).



Figure 2. Measure and Mark opposite Side of Stow Loop.

4. Cut along the $\frac{1}{4}$ -inch mark; then cut along the $\frac{3}{4}$ -inch mark and remove and discard the material (Figure 3).



Figure 3. Cut Damaged Stow Loop.

REPAIR-CONTINUED

5. Lay the ¼-inch side flat against the stow loop panel, and then lay the ¾-inch side flat over the ¼-inch side (Figure 4).

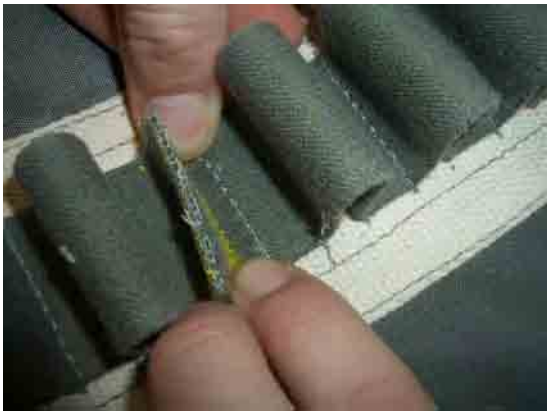

Figure 4. Prepare Stow Loop Panel for Sewing.

6. Using a medium-duty sewing machine, size E nylon thread, 7 to 11 stitches per inch, stitch ¼ inch in from cut edge, using three complete passes, over stitching by one stitch (Figure 5).



Figure 5. Sew Stow Loop.

7. Trim excess thread.

END OF TASK

REPLACE**WARNING**

Damage to two consecutive suspension line stow loops or three or more anywhere on the stow loop panel will require the replacement of the entire suspension line stow loop panel. Failure to comply may result in serious injury or death to the parachutist.

1. Mark the position of the damaged suspension line stow loop panel (Figure 6, Item 1) on the deployment bag.

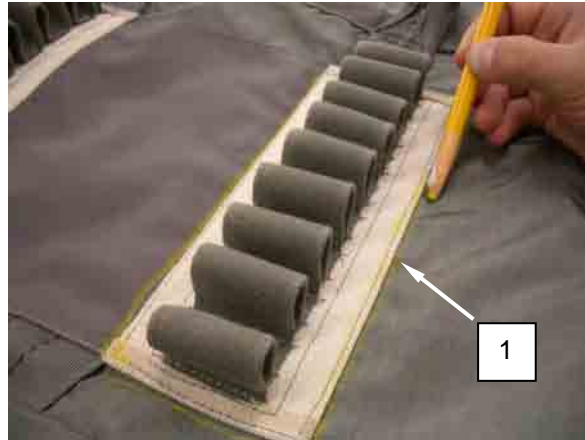

Figure 6. Mark Damaged Suspension Line Stow Loop Panel on Deployment Bag.

2. Note the location of the two rows of stitching that secure the suspension line stow loop panel to the deployment bag. Remove the stitching from the inside of the deployment bag that secures the suspension line stow loop panel to the deployment bag. Ensure that surrounding stitching of other components are not damaged (Figure 7).



Figure 7. Remove Stitching from Inside Deployment Bag.

REPLACE-CONTINUED

3. Remove the damaged suspension line stow loop panel (Figure 8, Item 1) and clean any loose remaining stitching.



Figure 8. Remove Damaged Suspension Line Stow Loop Panel.

4. Obtain a new suspension line stow loop panel (Figure 9, Item 1) from stock. Position the new suspension line stow loop panel (Figure 9, Item 1) in place using marks made previously as a guide. Fold over waxed edges at top and bottom so that the edge meets the base of the suspension line stow loop.

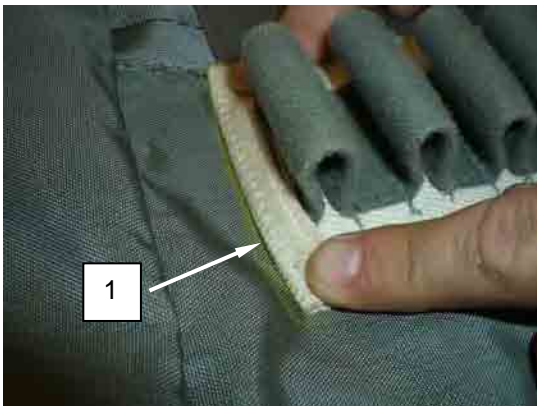

Figure 9. Position the New Suspension Line Stow Loop Panel in Place.

REPLACE-CONTINUED

5. Turn the deployment bag inside out to provide sewing access.
6. Use a medium-duty sewing machine with size E nylon thread to stitch 7 to 11 stitches per inch. Starting at the top inside corner, place one row of stitching $\frac{1}{8}$ inch in from the outer edge of the suspension line stow loop panel (Figure 10, Item 1), making a $\frac{1}{2}$ inch locking stitch by finishing at the outside corner.



Figure 10. Sew Outer Edge of Suspension Line Stow Loop Panel.

7. Starting at the same end as the first row of stitching, place a second row of stitching around the suspension line stow loop panel (Figure 11, Item 1), putting the presser foot of the sewing machine flush up against the edges of the stow loops, using that as a sewing guide. The finished stitch should be approximately $\frac{1}{4}$ inch from the suspension line stow loops. Make a $\frac{1}{2}$ -inch locking stitch by finishing at the outside corner.

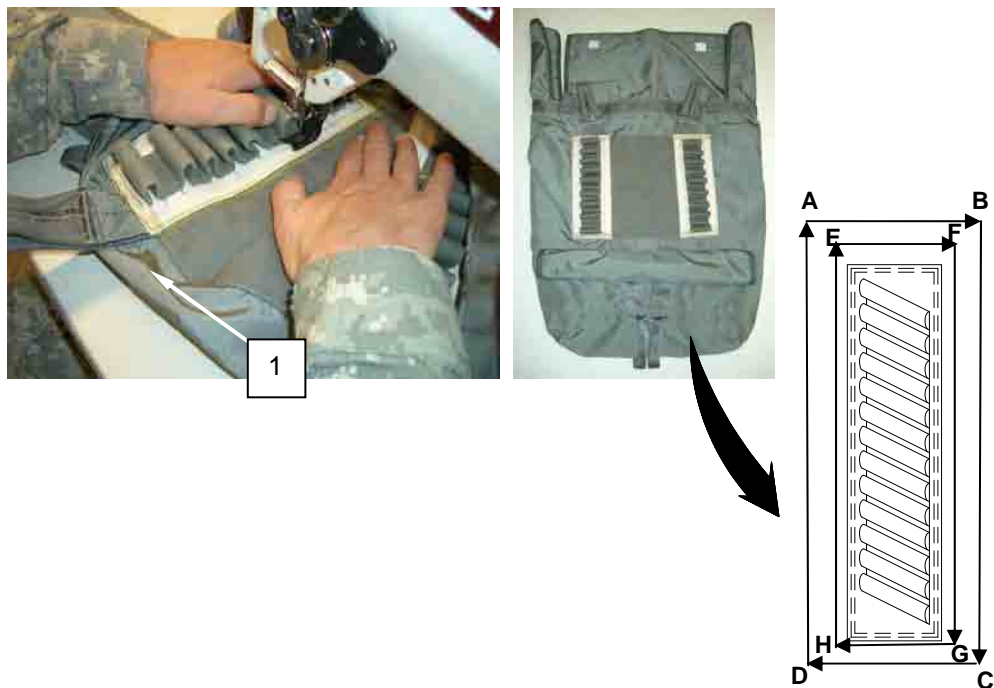

Figure 11. Sew Second Row of Stitching Around Suspension Line Stow Loop Panel.

END OF TASK

END OF WORK PACKAGE

FIELD MAINTENANCE**MAIN DEPLOYMENT BAG LOCKING STOW LOOP
REPAIR**

INITIAL SETUP:**Tools and Special Tools**

Sewing Machine, Medium Duty (WP 0102,
Item 59)
Scissors, 8 Inch (WP 0102, Item 48)

Personnel Required

Parachute Rigger 92R1P (1)

Materials/Parts

Thread, Nylon, V-T-295, Type I or II, Size E,
FG504 (WP 0101, Item 54)

References

WP 0016

Equipment Condition

Unpacked

REPAIR

Lay out on packing table or other suitable area.

NOTE

No other repairs are authorized for the locking stow loop.

Repair exposed stitching only IAW WP 0016, stitching and re-stitching.

END OF TASK

END OF WORK PACKAGE

FIELD MAINTENANCE

**MAIN DEPLOYMENT BAG TIE DOWN LOOP
REPAIR, REPLACE**

INITIAL SETUP:**Tools and Special Tools**

Heated Blade Cutter (WP 0102, Item 18)
 Sewing Machine, Medium Duty (WP 0102, Item 59)
 Sewing Machine, Bartack, Industrial (WP 0102, Item 50)
 Stitch Removal Tool (WP 0102, Item 64)
 Tape, Measuring (WP 0102, Item 65)

Personnel Required

Parachute Rigger 92R1P (1)

Materials/Parts

Pencil, China Marker, Yellow, A-A-87 (WP 0106, Item 30)
 Tape, Textile, Nylon, Type II, Class 1A, 1 inch wide, FG504 (WP 0106, Item 44)
 Thread, Nylon, V-T-295, Type I or II, Size E FG504 (WP 0106, Item 54)
 Thread, Nylon, V-T-295, Type I, II or III, Class A, Size FF, Color FG504 (WP 0106, Item 70)

Equipment Condition

Unpacked

REPAIR**Repair Limitations**

1. Two tie-down loops per panel may be torn, if the tear does not exceed half the width of the tie-down loop, and the torn tie-down loops are not adjoining.
2. If 50% of stitching is loose or broken on one tie-down loop, re-stitch the tie-down loop to the main deployment bag. If stitching in more than one adjacent tie-down loop is broken more than $\frac{3}{4}$ inch in either tie-down loop, then re-stitch all tie-down loops on that side. Use a medium-duty sewing machine, size FF, nylon thread, and 7 to 11 stitches per inch.

Re-stitching. Stitch and re-stitch with size E nylon thread that's contrasting in color of the original stitching, when possible. Lock all straight stitching by backstitching at least $\frac{1}{2}$ inch. Re-stitch directly over the original stitching; follow the original stitch pattern as closely as possible.

REPLACE

1. Lay out on packing table or other suitable area.
2. Cut stitching, and remove damaged loop (Figure 1, Item 1). Remove any loose stitching.



Figure 1. Remove Damaged Loop and Stitching.

3. Cut a 5-inch length of 1-inch wide, Type II nylon webbing (Figure 2, Item 1) and sear ends of webbing.

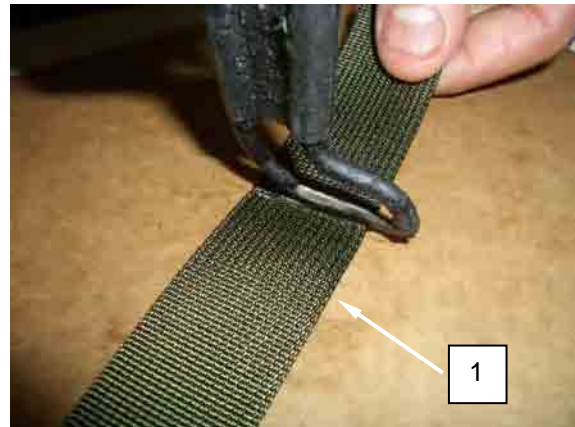
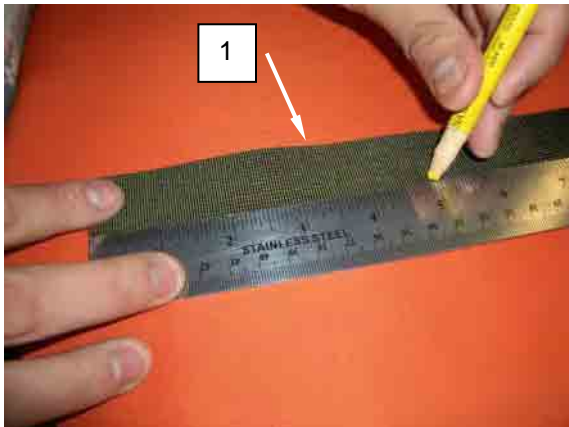

Figure 2. Cut New Tie-Down Loop Webbing.

REPLACE - CONTINUED

4. Mark 2 inches from one end. Fold the outside edges in at the mark meeting at center (Figure 3).



Figure 3. Mark and Fold Webbing.

NOTE

A $\frac{1}{8}$ - x $\frac{1}{2}$ -inch, 42-stitch bartack can be used.

5. Using a medium-duty sewing machine, size E nylon thread, 7 to 11 stitches per inch, stitch along the mark using three complete passes (Figure 4).



Figure 4. Stitch Along the Mark Using Three Complete Passes.

REPLACE - CONTINUED

6. Fold material at stitching forming a loop (Figure 5, Item 1).

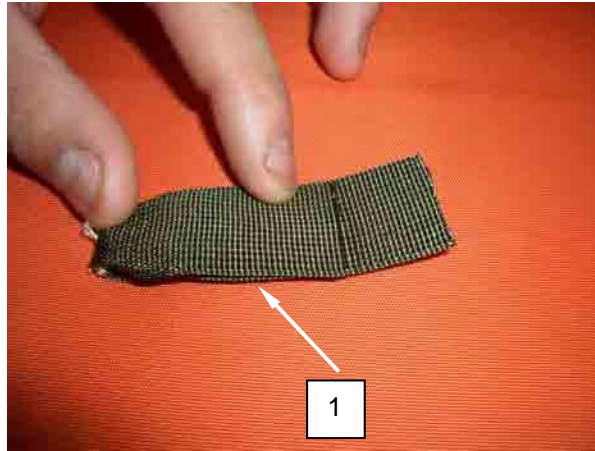

Figure 5. Fold Material at Stitching Forming a Loop.

7. Fold along running end (Figure 6, Item 1) over short running end.

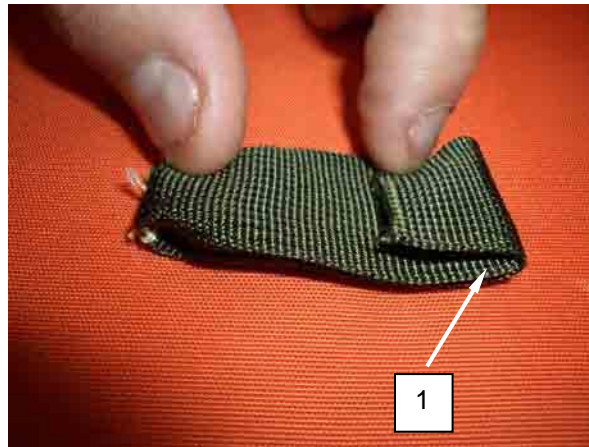

Figure 6. Fold Along Running End over Short Running End.

8. Position the new loop in the same place the damaged loop was removed (Figure 7).



Figure 7. Position the New Loop.

REPLACE - CONTINUED

9. Using a medium-duty sewing machine, size FF nylon thread, 7 to 11 stitches per inch, stitch new loop (Figure 8, Item 1) per original stitching pattern, complete three passes of stitching from edge to edge over stitching by one stitch.

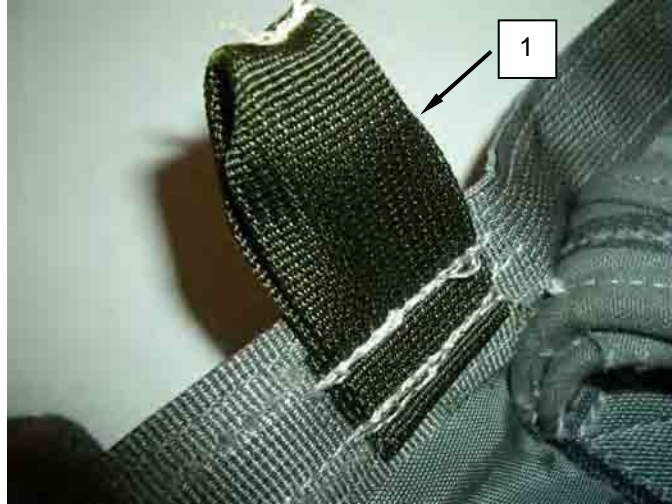

Figure 8. Stitch the New Loop.

END OF TASK

END OF WORK PACKAGE

FIELD MAINTENANCE**MAIN DEPLOYMENT BAG SIDE FLAPS
REPAIR**

INITIAL SETUP:**Tools and Special Tools**

Sewing Machine, Darning (WP 0102, Item 52)
Sewing Machine, Light Duty (WP 0102, Item 57)

Personnel Required

Parachute Rigger 92R1P (1)

References

WP 0016

Materials/Parts

Thread, Nylon, V-T-295, Type I or II, Size E,
FG504 (WP 0101, Item 54)

Equipment Condition

Unpacked

REPAIR

Re-stitching. Stitch and re-stitch with size E nylon thread that's contrasting in color of the original stitching, when possible. Lock all straight stitching by backstitching at least $\frac{1}{2}$ inch. Re-stitch directly over the original stitching; follow the original stitch pattern as closely as possible.

Re-stitch IAW WP 0016.

Darning Small Holes or Tears

Darn small holes or tears in the side flaps if the holes or tears do not exceed $\frac{3}{4}$ inch in length or diameter. Darn IAW WP 0016.

END OF TASK**END OF WORK PACKAGE**

FIELD MAINTENANCE

PACKING LOOP
REPAIR, REPLACE**INITIAL SETUP****Tools and Special Tools**

Heated Blade Cutter (WP 0102, Item 18)
 Sewing Machine, Bartack, Industrial
 (WP 0102, Item 50)
 Shears, Tailors, 12 inch (WP 0102, Item 61)
 Stitch Removal Tool (WP 0102, Item 64)
 Tape, Measuring (WP 0102, Item 65)

Personnel Required

Parachute Rigger 92R1P (1)

Equipment Condition

Unpacked

Materials/Parts

Pencil, China Marker, Yellow, A-A-87 (WP
 0101, Item 30)
 Thread, Nylon, V-T-295, Type I or II, Size E,
 FG504 (WP 0101, Item 54)
 Webbing, Nylon, Type 1, Class 2, 9/16 inch
 wide, Natural (WP 0101, Item 63)

References

WP 0016

REPAIR**Re-stitch Packing Loops****CAUTION**

Stitch removal requirements will vary according to the type of item being repaired. Due to the unique type of stitch formations found on the T-11 Personnel Parachute System, use of a stitch removal tool is mandated when removing bartack stitch formations.

If bartack stitching requires repair, bartacks will be completely removed and a new bartack will be replaced with the same stitch length and width. Re-stitch using a bartack sewing machine with size E thread, 42-stitch bartack. Bartack specifications are found in WP 0016.

END OF TASK

REPLACE**Replace Packing Loop**

1. Mark the edges of the damaged packing loop (Figure 1).



Figure 1. Marking Position of Original Packing Loop.

2. Using a stitch removal tool, remove damaged packing loop (Figure 2). Remove loose thread.



Figure 2. Removing Damaged Packing Loop with Stitch Removal Tool.

REPLACE - CONTINUED

- Using the heated blade cutter cut an 8-inch length of Type I nylon webbing and fold in half (Figure 3).



Figure 3. Cutting an 8-inch Length of Type I Nylon Webbing.

- Orient the new loop toward the bridle attachment assembly.
- Using a bartack sewing machine, size E nylon thread, place a $\frac{1}{8}$ - x $\frac{3}{4}$ -inch, 42-stitch bartack on the new loop in the same location as the original loop starting $\frac{1}{8}$ -inch from the cut edge of the loop (Figure 4).



Figure 4. Sewing New Packing Loop to Canopy.

END OF TASK

END OF WORK PACKAGE

FIELD MAINTENANCE

**PACKING TAB
REPAIR, REPLACE**
INITIAL SETUP**Tools and Special Tools**

Heated Blade Cutter (WP 0102, Item 18)
 Sewing Machine, Bartack, Industrial
 (WP 0102, Item 50)
 Shears, Tailors, 12 inch (WP 0102, Item 61)
 Stitch Removal Tool (WP 0102, Item 64)
 Tape, Measuring (WP 0102, Item 65)

Personnel Required

Parachute Rigger 92R1P (1)

Materials/Parts

Pencil, China Marker, Yellow, A-A-87 (WP
 0106, Item 30)
 Thread, Nylon, V-T-295, Type I or II, Size E,
 FG504 (WP 0106, Item 54)
 Webbing, Nylon, Type III, Class 1A, 3/4 inch
 Wide, FG504 (WP 0106, Item 64)

References

WP 0016

REPAIR**Re-stitch Packing Tab****CAUTION**

Stitch removal requirements will vary according to the type of item being repaired. Due to the unique type of stitch formations found on the T-11 Personnel Parachute System, use of a stitch removal tool is mandated when removing bartack stitch formations.

If bartack stitching requires repair, bartacks will be completely removed and a new bartack will be replaced with the same stitch length and width. Re-stitch using a bartack sewing machine with size E thread, 42-stitch bartack. Refer to WP 0016 for bartack stitching specifications.

END OF TASK

REPLACE**Replace Packing Tab**

1. Mark the edges of the damaged packing tab (Figure 1).



Figure 1. Marking Position of Original Packing Tab.

2. Using a stitch removal tool, carefully remove damaged packing tab (Figure 2). Remove loose stitching.



Figure 2. Removing Damaged Packing Tab with Stitch Removal Tool.

REPLACE - CONTINUED

- Using the heated blade cutter cut a 15½-inch length of Type I nylon webbing and fold in half (Figure 3).

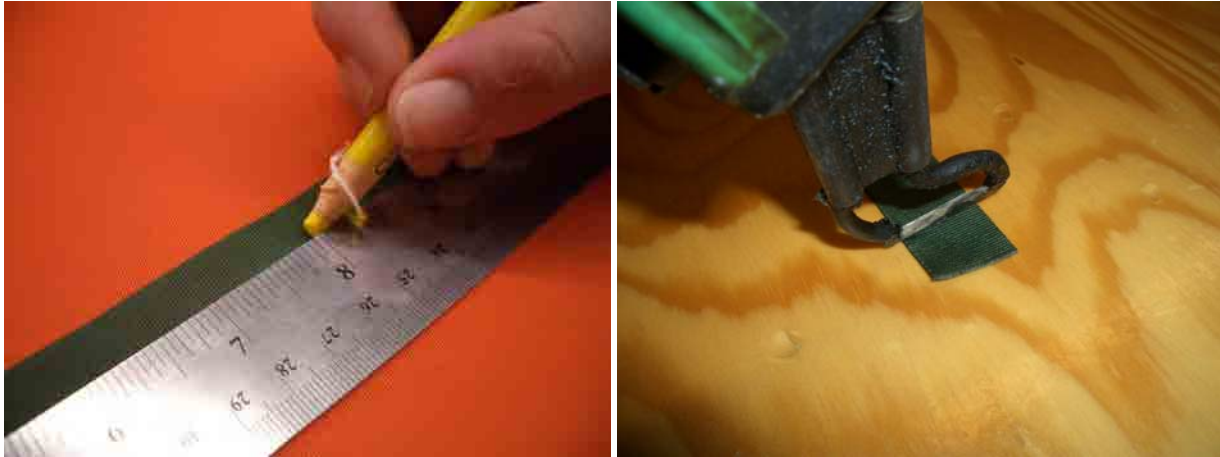

Figure 3. Cutting a 15½-inch Length of Type I Nylon Webbing.

- Orient the new tab toward the bridle attachment assembly.
- Fold the end of the new tab under ½ inch.
- Using a bartack sewing machine, size E nylon thread, place a 1/8- x 3/4-inch, 42-stitch bartack in the same location as the original tab starting 1/8 inch from the cut edge of the tab (Figure 4).



Figure 4. Sewing New Packing Tab to Canopy.

END OF TASK

END OF WORK PACKAGE

FIELD MAINTENANCE

**MODIFIED PERSONNEL STATIC LINE
REPLACE**

INITIAL SETUP:

Tools and Special Tools

None required

Personnel Required

Parachute Rigger 92R1P (1)

Materials/Parts

None required

Equipment Condition

Unpacked

REPLACE

Remove Static Line

Remove the unserviceable portion of the static line (Figure 1, Item 1) from the deployment bag (Figure 1, Item 2) or USL snap hook and replace it with a serviceable item from stock.

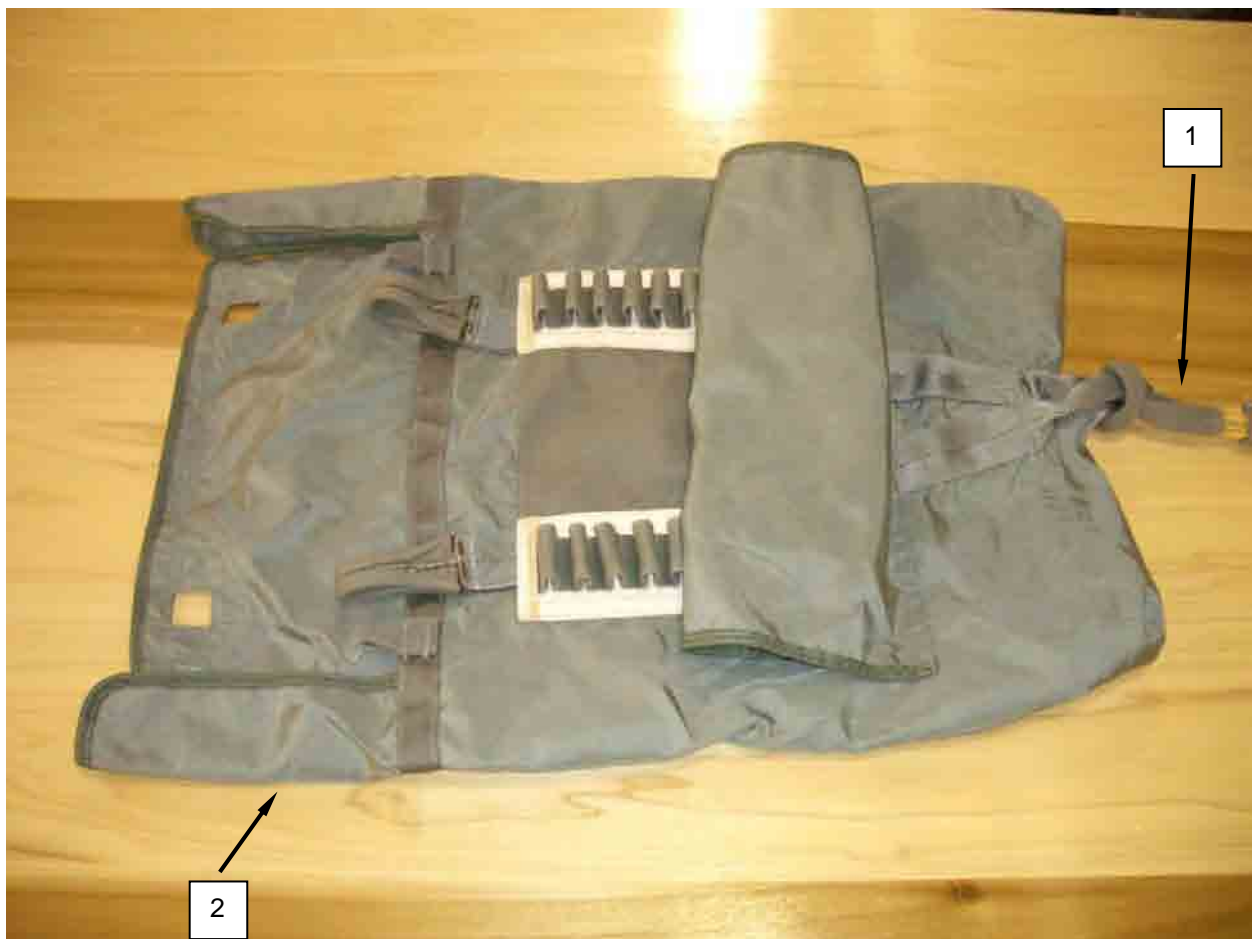

Figure 1. Remove Unserviceable Portion of Static Line.

REPLACE - CONTINUED**Replace Static Line****NOTE**

When laying out the static line to form the girth hitch, ensure the green ID marking thread of the webbing is on the top.

1. Attaching the static line to the deployment bag.
 - a. Position the deployment bag (Figure 2, Item 1) with the stow loops facing up and pass the 6-inch buffer loop (Figure 2, Item 2) of the static line clockwise, halfway through the break cord attaching strap loop (Figure 2, Item 3).



Figure 2. Position Deployment Bag with Stow Loops Facing Up.

- b. Pass the 3½-inch loop end of the static line (Figure 3, Item 1) through the 6-inch buffer loop (Figure 3, Item 2), counterclockwise until a taut girth hitch is formed.



Figure 3. Static Line through the 6-Inch Buffer Loop.

REPLACE - CONTINUED

- c. Secure the static line (Figure 4, Item 1) to the deployment bag (Figure 4, Item 2).



Figure 4. Secure Static Line to Deployment Bag.

- 2. Attaching the snap hook to the static line and the USL 5-foot extension.
 - a. Position the snap hook (Figure 5, Item 1) so the opening is facing outward. Lay the static line (Figure 5, Item 2) flat on the packing table; ensure the green ID marking thread is on top and on the outside of the loop.

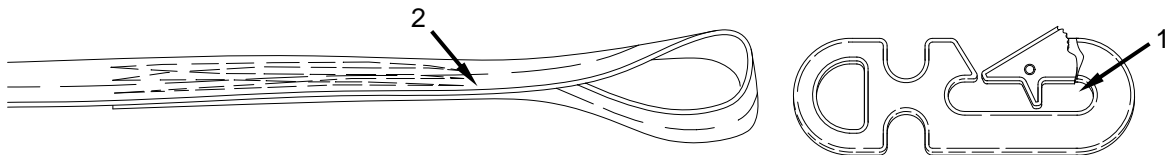

Figure 5. Position the Snap Hook.

- b. Pass the 3½-inch loop end of the static line (Figure 6, Item 1) through the opening in the base of the snap hook (Figure 6, Item 2), from bottom to top.

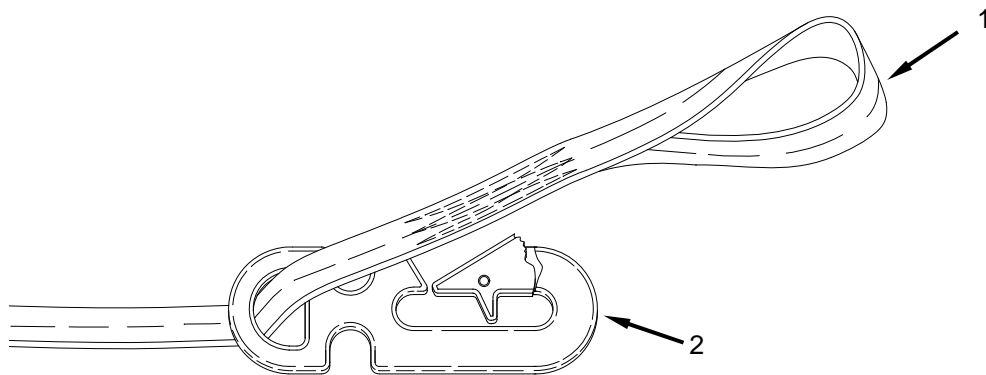

Figure 6. Pass the 3½-inch Loop End of Static Line through Opening of Snap Hook.

REPLACE - CONTINUED

- c. Pass the top of the snap hook (Figure 7, Item 1) through the static line loop (Figure 7, Item 2).

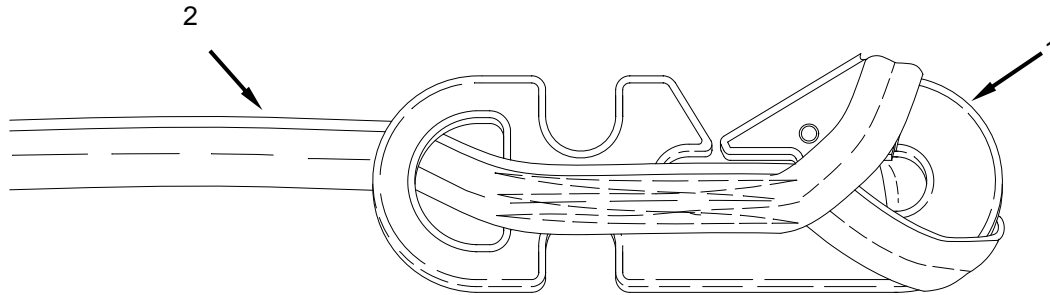

Figure 7. Pass Top of Snap Hook through Static Line Loop.

- d. Continue passing the snap hook (Figure 8, Item 1) through the static line loop (Figure 8, Item 2); pull the excess static line back through the opening in the base of the snap hook until the loop is past the snap hook opening.
- e. Slide the loop down to the bottom of the snap hook until the static line is fully seated in the indent on the side of the snap hook; form a taut girth hitch.

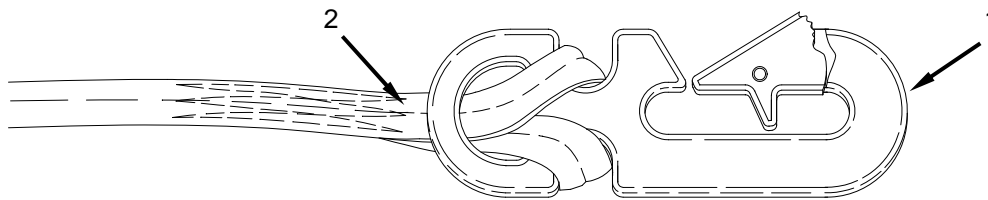

Figure 8. Form a Taut Girth Hitch.

- f. Ensure there are no twists in the static line snap hook loop.

NOTE

Before forming the girth hitch, the green ID marking thread on the static line and the USL 5-foot extension must be on top.

3. Attaching the USL 5-foot extension to the static line.
- a. Attach the USL snap hook to the USL 5-foot extension as stated in step 2 above.

REPLACE - CONTINUED

- b. Pass the 3½-inch loop (Figure 9, Item 1) on the static line, through the 2-inch buffer loop (Figure 9, Item 2) on the USL 5-foot extension.

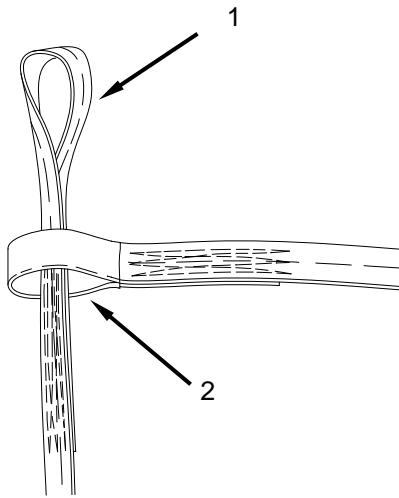

Figure 9. Pass the 3½-Inch Loop on the Static Line through the 2-Inch Buffer Loop.

- c. Pass the snap hook (Figure 10, Item 1) of the USL 5-foot extension through the 3½-inch loop (Figure 10, Item 2) on the static line.

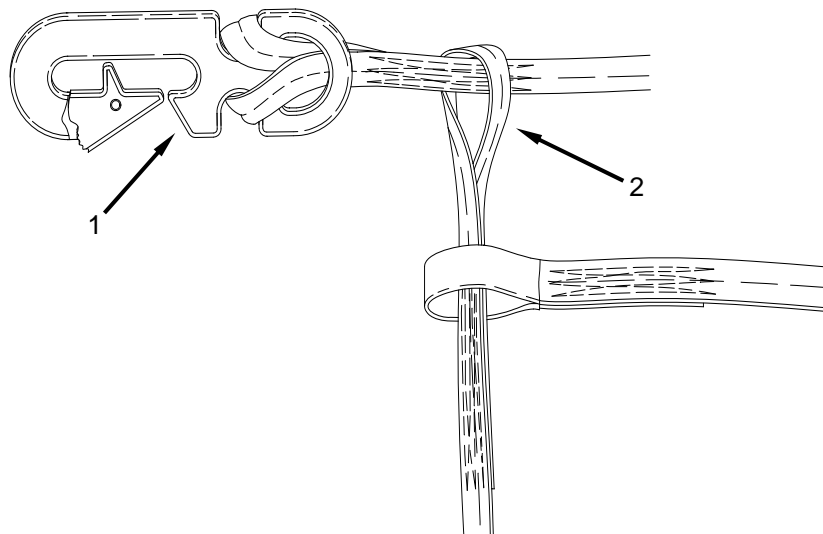

Figure 10. Pass Snap Hook of USL 5-Foot Extension through Loop on Static Line.

REPLACE - CONTINUED

- d. Continue passing the snap hook through the 3½-inch loop until a taut girth hitch is made securing the 5-foot extension to the static line (Figure 11, Item 1). (There will be a half-twist in the 3½-inch loop when forming the girth hitch.)

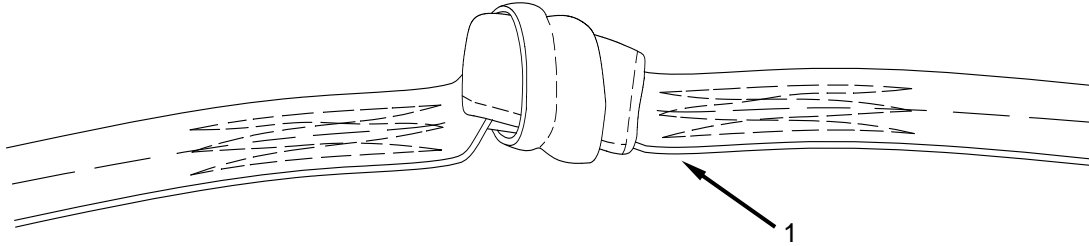

Figure 11. Girth Hitch Securing the 5-Foot Extension to Static Line.

END OF TASK

END OF WORK PACKAGE

FIELD MAINTENANCE

PERSONNEL PARACHUTE STATIC LINE EXTENSION
REPLACE

INITIAL SETUP

Tools and Special Tools

None required

Personnel Required

Parachute Rigger 92R1P (1)

Materials/Parts

None required

REPLACE

Remove Static Line Extension

1. Untie and remove the unserviceable static line extension (Figure 1, Item 1) from the static line (Figure 1, Item 2).

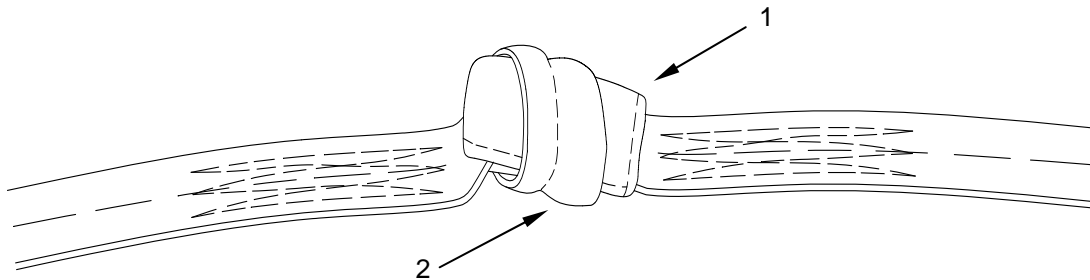

Figure 1. Remove 5-foot Extension from Static Line.

2. Remove the snap hook from the USL 5-foot extension.
 - a. Slide the loop up (Figure 2, Item 1) from the bottom of the snap hook (Figure 2, Item 2) until the static line is fully removed from the indent (Figure 2, Item 3) on the side of the snap hook.
 - b. Continue passing the USL 5-foot extension line loop (Figure 2, Item 1) over the snap hook (Figure 2, Item 2); pull the excess static line through the opening in the base of the snap hook (Figure 2, Item 2) until the loop is past the snap hook opening.

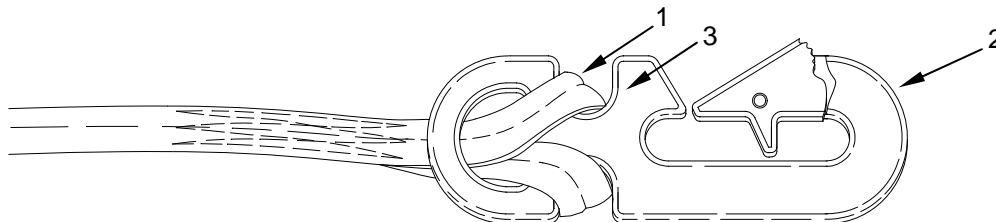

Figure 2. Slide Loop from Bottom of Snap Hook and Remove from Indent.

REPLACE – CONTINUED

- c. Pass the static line loop (Figure 3, Item 1) over the top of the snap hook (Figure 3, Item 2).

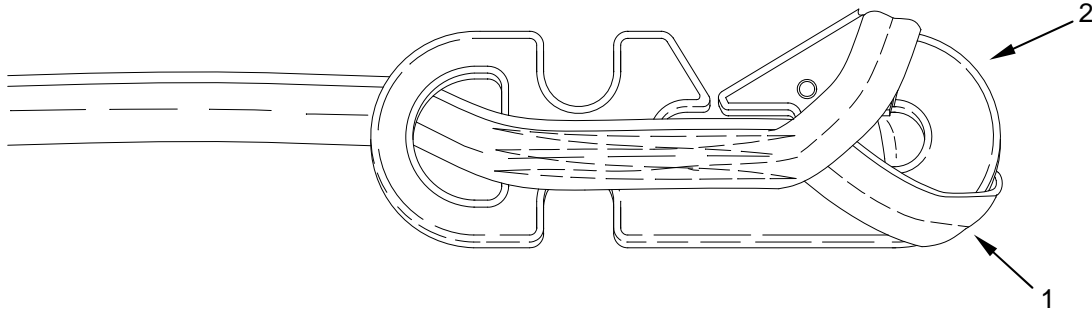

Figure 3. Pass Static Line Loop over Top of Snap Hook.

- d. Pass the static line extension (Figure 4, Item 1) through the opening in the base of the snap hook (Figure 4, Item 2), from bottom to top.
- e. Remove unserviceable static line extension.

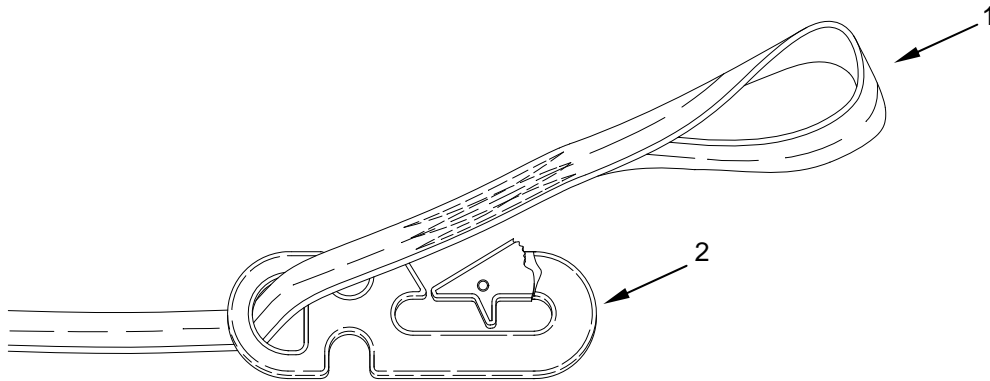

Figure 4. Pass Loop End of Static Line Extension through Opening in Base of Snap Hook.

REPLACE – CONTINUED**Replace Static Line Extension**

3. Attaching the snap hook to the USL 5-foot extension.
 - a. Position the snap hook (Figure 5, Item 1) so the opening is facing outward. Lay the static line extension (Figure 5, Item 2) flat on the packing table; ensure the green ID marking thread is on top and on the outside of the loop.

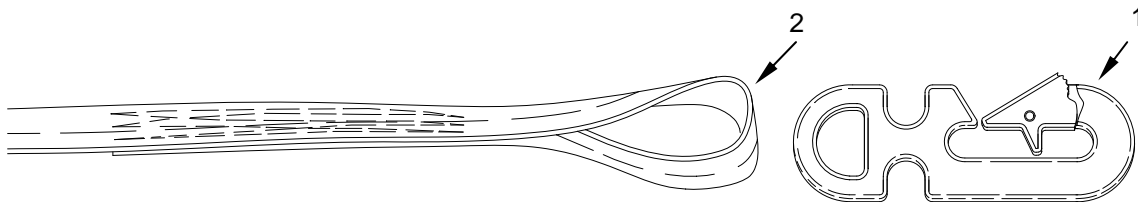

Figure 5. Attaching Snap Hook to Static Line and USL 5-foot Extension.

- b. Pass the 3½-inch loop end of the static line extension (Figure 6, Item 1) through the opening in the base of the snap hook (Figure 6, Item 2), from bottom to top.

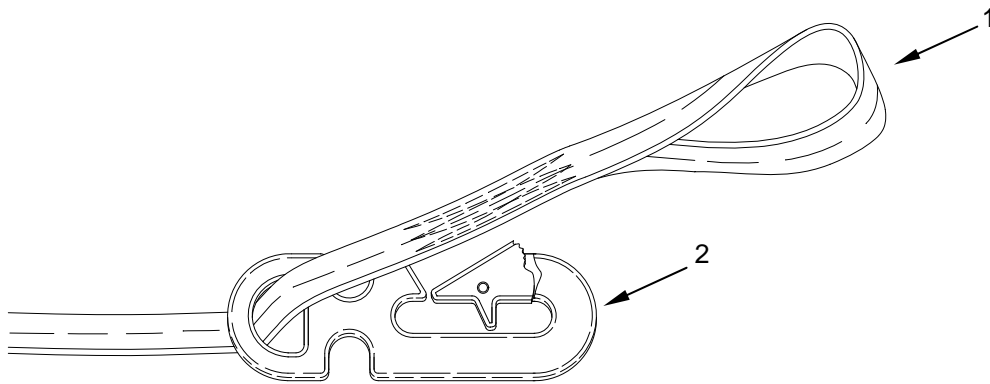

Figure 6. Pass 3½-Inch Loop End of Static Line through Opening in Base of Snap Hook.

REPLACE – CONTINUED

- c. Pass the top of the snap hook (Figure 7, Item 1) through the static line extension loop (Figure 7, Item 2).

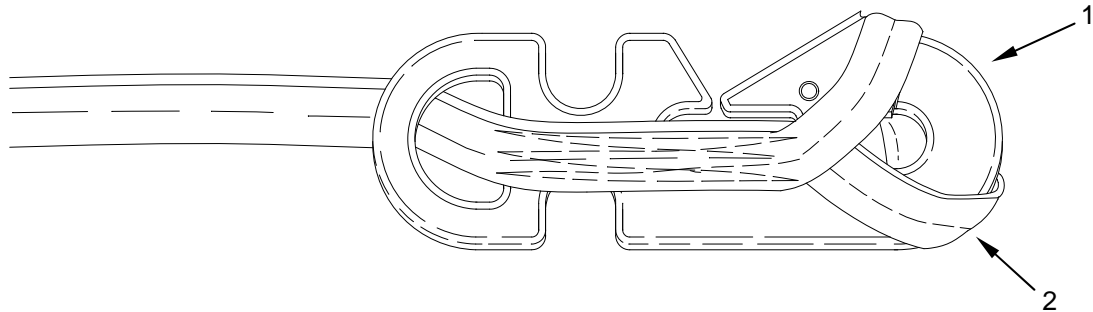

Figure 7. Pass Top of Snap Hook through the Static Line Loop.

- d. Continue passing the snap hook (Figure 8, Item 1) through the static line extension loop (Figure 8, Item 2); pull the excess static line extension back through the opening in the base of the snap hook (Figure 8, Item 1) until the loop is past the snap hook opening.
- e. Slide the loop down to the bottom of the snap hook until the static line is fully seated in the indent (Figure 8, Item 3) on the side of the snap hook; form a taut girth-hitch.

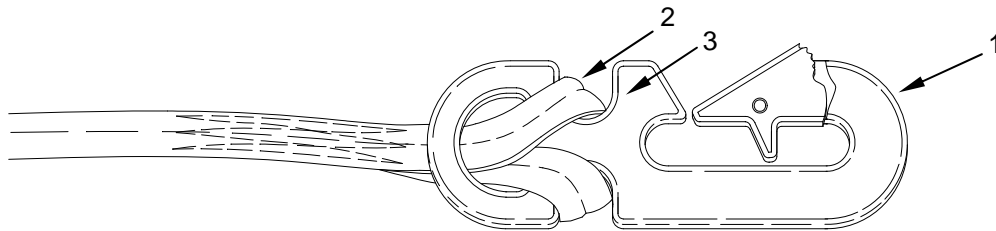

Figure 8. Snap Hook through the Static Line Loop Secured with Girth-Hitch.

- f. Ensure there are no twists in the static line extension snap hook loop.

NOTE

Before forming the girth-hitch, the green ID marking thread on the USL 5-foot extension must be on top.

4. Attaching the USL 5-foot extension to the static line.
- a. Pass the 3½-inch loop on the static line (Figure 9, Item 1); through the 2-inch buffer loop (Figure 9, Item 2) on the USL 5-foot extension.

REPLACE – CONTINUED

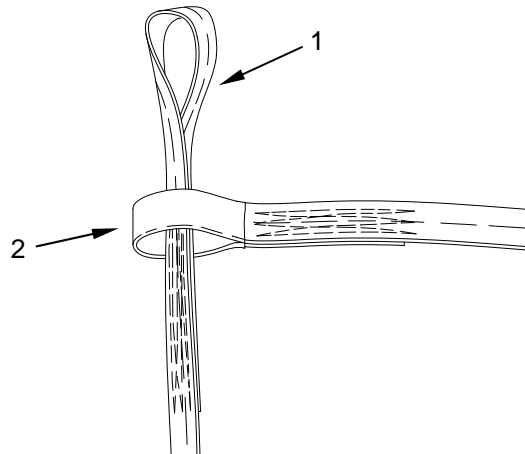

Figure 9. Attach the USL 5-foot Extension to Static Line.

- b. Pass the snap hook of the USL 5-foot extension (Figure 10, Item 1) through the 3½-inch loop (Figure 1, Item 2) on the static line.

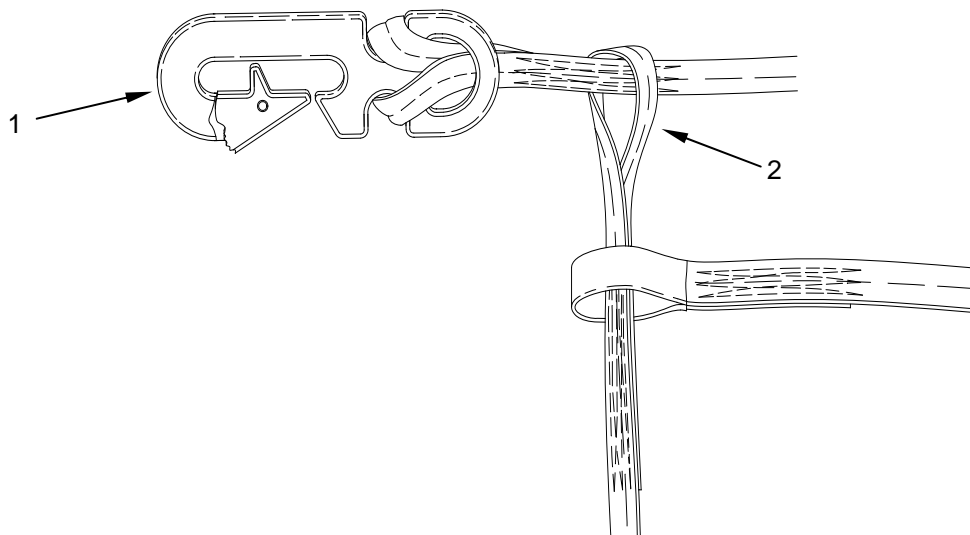

Figure 10. Pass Snap Hook of USL 5-foot Extension through the 3½-Inch Loop on the Static Line.

- c. Continue passing the snap hook through the 3½-inch loop until a taut girth-hitch is made securing the 5-foot extension (Figure 11, Item 1) to the static line (Figure 11, Item 2). (There will be a half-twist in the 3½-inch loop when forming the girth-hitch.)

REPLACE – CONTINUED

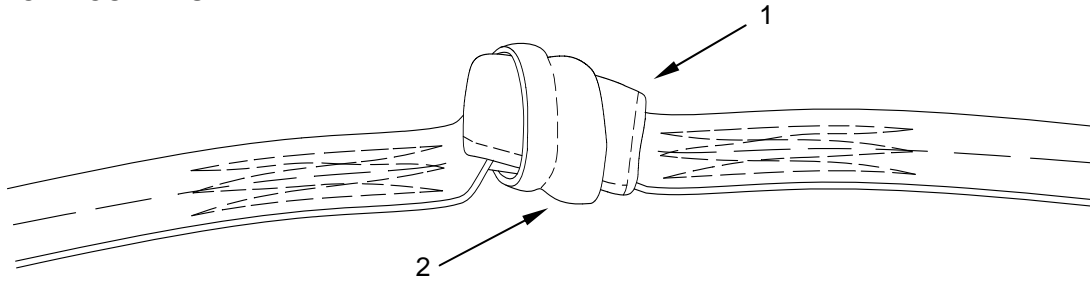

Figure 11. Secure 5-foot Extension to Static Line with Taut Girth-Hitch.

END OF TASK

END OF WORK PACKAGE

FIELD MAINTENANCE
STATIC LINE SNAP HOOK
REPLACE

INITIAL SETUP**Tools and Special Tools**

None required

Personnel Required

Parachute Rigger 92R1P (1)

Materials/Parts

None required

REPLACE**Remove Static Line Snap Hook**

1. Remove the unserviceable USL snap hook and replace it with a serviceable item from stock.
 - a. Slide the static line loop or USL 5-foot extension line loop up (Figure 1, Item 1) from the bottom of the snap hook (Figure 1, Item 2) until the static line is fully removed from the indent (Figure 1, Item 3) on the side of the snap hook.
 - b. Continue passing the loop (Figure 1, Item 1) over the snap hook (Figure 1, Item 2); pull the excess static line or USL 5-foot extension line through the opening in the base of the snap hook (Figure 1, Item 2) until the loop is past the snap hook opening.

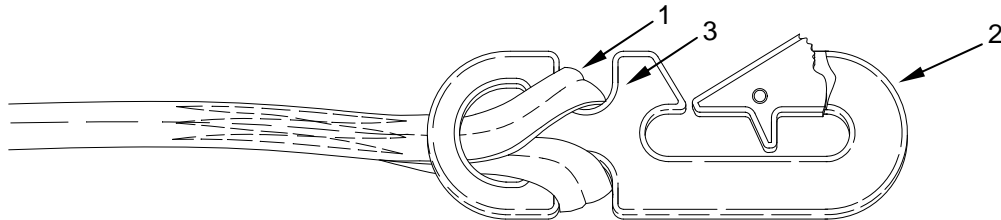

Figure 1. Slide Loop from Bottom of Snap Hook and Remove from Indent.

REPLACE – CONTINUED

- c. Pass the static line loop (Figure 2, Item 1) over the top of the snap hook (Figure 2, Item 2).

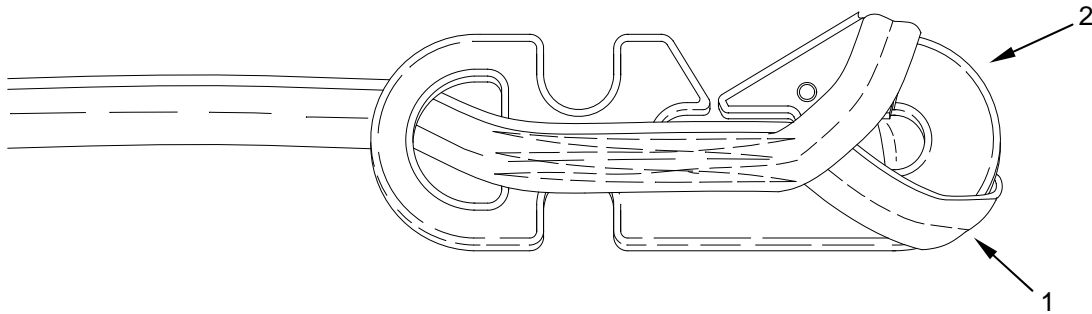

Figure 2. Pass Loop over Top of Snap Hook.

- d. Pass the static line extension (Figure 3, Item 1) through the opening in the base of the snap hook (Figure 3, Item 2), from bottom to top.
- e. Remove unserviceable USL snap hook.

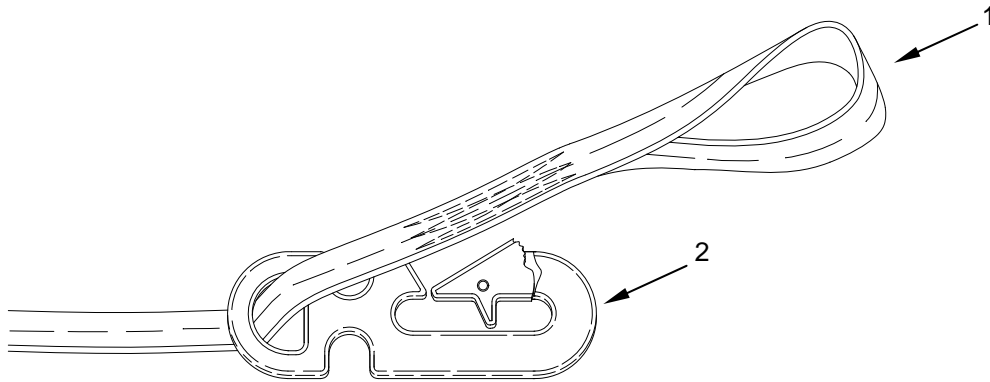

Figure 3. Pass Loop End of Static Line or Static Line Extension through Opening in Base of Snap Hook.

REPLACE – CONTINUED

2. Attaching the snap hook to the static line and the USL 5-foot extension.

- a. Position the snap hook (Figure 4, Item 1) so the opening is facing outward. Lay the static line (Figure 4, Item 2) flat on the packing table; ensure the green ID marking thread is on top and on the outside of the loop.

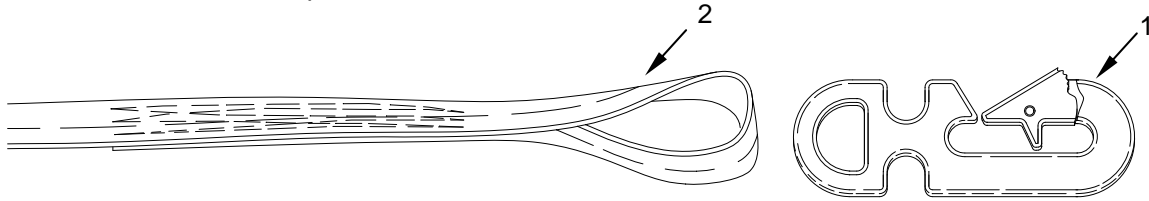

Figure 4. Attaching Snap Hook to Static Line and USL 5-foot Extension.

- b. Pass the 3½-inch loop end of the static line (Figure 5, Item 1) through the opening in the base of the snap hook (Figure 5, Item 2), from bottom to top.

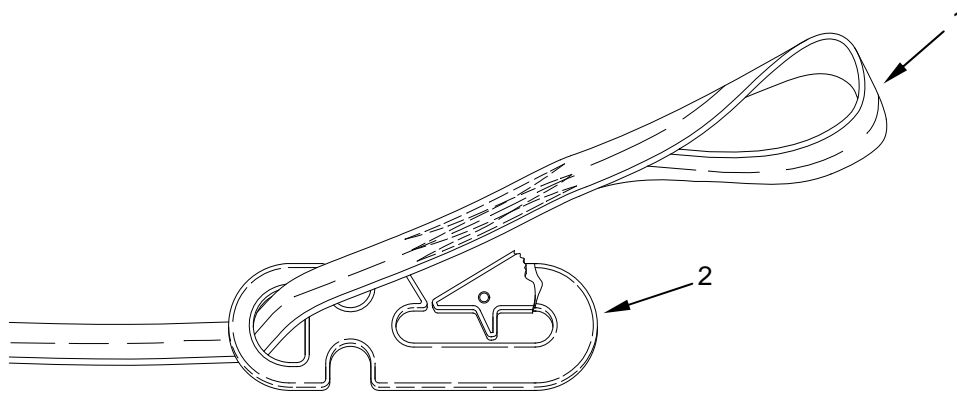

Figure 5. Pass 3½-Inch Loop End of Static Line through Opening in the Base of Snap Hook.

- c. Pass the top of the snap hook (Figure 6, Item 1) through the static line loop (Figure 6, Item 2).

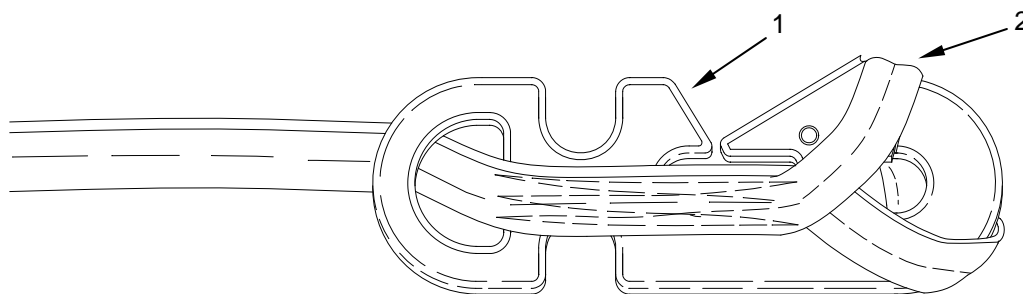

Figure 6. Pass Top of Snap Hook through the Static Line Loop.

REPLACE – CONTINUED

- d. Continue passing the snap hook (Figure 7, Item 1) through the static line loop (Figure 7, Item 2); pull the excess static line back through the opening in the base of the snap hook until the loop is past the snap hook opening.
- e. Slide the loop down to the bottom of the snap hook until the static line is fully seated in the indent (Figure 7, Item 3) on the side of the snap hook; form a taut girth-hitch.

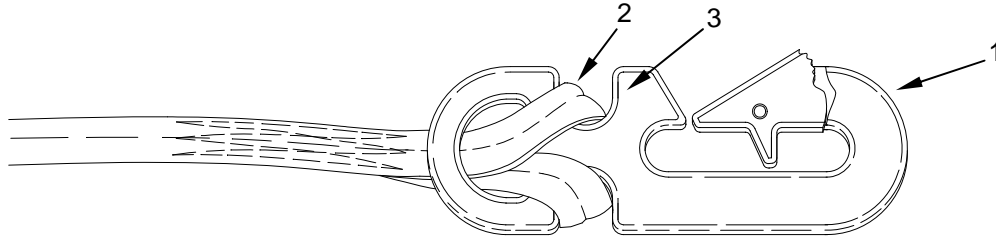

Figure 7. Snap Hook through Static Line Loop Secured with Girth-Hitch.

- f. Ensure there is no twists in the static line snap hook loop.

END OF TASK

END OF WORK PACKAGE

FIELD MAINTENANCE

PREPARATION FOR STORAGE OR SHIPMENT

INITIAL SETUP:**Tools and Special Tools**

None required

Personnel Required

Parachute Rigger 92R1P (1)

Materials/Parts

None required

References

AR 700-15
 AR 750-1
 TM 10-1670-201-23/T.O. 13C-1-41/NAVAIR 13-1-17

Equipment Condition

Unpacked

PREPARATION FOR STORAGE OR SHIPMENT**Storage Criteria**

Administrative storage of the T-11 Personnel Parachute System will be accomplished in accordance with AR 750-1, and the instructions furnished below.

General Storage Requirements

To ensure that serviceability standards of the stored parachute assembly are maintained, every effort will be exerted to adhere to the following general storage requirements:

1. T-11 Personnel Parachute System and T-11 Reserve parachutes do not require co-location when storing.
2. Pyramid stacking of main parachutes will be no greater than 7 high and reserve parachutes will be no greater than 11 high.
3. When available, a climate controlled building should be used to store parachutes.
4. Parachutes will be stored in a dry, well-ventilated location and protected from pilferage, dampness, fire, dirt, insects, rodents, and direct sunlight.
5. Parachutes will not be stored in a manner that which would prevent ventilation or interfere with light fixtures, heating vents, fire fighting devices, cooling units, exits, or fire doors.
6. Parachutes will not be stored in a damaged, dirty, or damp condition.
7. All stored parachute items will be marked, segregated, and located for accessibility and easy identification.

PREPARATION FOR STORAGE OR SHIPMENT - CONTINUED

8. Parachutes will not be stored in direct contact with any building floor or wall. Storage will be accomplished using bins, shelves, pallets, racks, or dunnage to provide airspace between the storage area floor and the equipment. If the pre-constructed shelving or similar storage accommodations are not available, locally fabricate storage provisions using suitable lumber or wooden boxes.
9. All available material handling equipment should be used as much as possible in the handling of parachutes.
10. Periodic rotation of stock, conversion of available space, proper housekeeping policies, and strict adherence to all safety regulations will be practiced at all times.

Storage Specifics for Parachutes

In addition to the storage requirements stipulated in the general storage requirements paragraph on the previous page, the following is a list of specifics that must be enforced when storing parachutes:

1. Except for those assemblies required for contingency operation, parachutes will not be stored in a packed configuration.
2. Stored parachute assemblies will be secured from access by unauthorized personnel.
3. A parachute that is in storage, and is administered a cyclic repack and inspection, will not be exposed to incandescent light or indirect sunlight for a period of more than 36 hours. In addition, exposure to direct sunlight will be avoided entirely.

In-Storage Inspection

1. General Information. An in-storage inspection is a physical check conducted on a random sample of parachutes that are located in storage.
2. Intervals. The T-11 Personnel Parachute System in-storage will be inspected at least once every 180 calendar days and at more frequent intervals if prescribed by the local parachute maintenance officer.
3. Inspection. Inspect to ensure that the parachute is ready for issue.
4. Check the parachute for proper identification.
5. Check that no damage or deterioration has been incurred.
6. Ensure that all modifications or similar requirements have been completed.
7. Check the adequacy of the storage facilities, efforts taken to control pests and rodents, and protection against unfavorable climatic conditions.

Preparation for Initial Shipment

The initial packaging and shipping of parachutes are the responsibility of item manufacturers, who are required to comply with federal and military packing specifications, as stipulated in contractual agreements. Parachutes are normally shipped to depot activities, by domestic freight or parcel post, and packed to comply with overseas shipping requirements. Except for those parachute that are unpackaged and subjected to random inspections or testing by depot activity, parachutes received by a using unit will be contained in the original packaging materials.

PREPARATION FOR STORAGE OR SHIPMENT - CONTINUED

Preparation for Shipping between Maintenance Activities

The shipping of parachutes between activities will be accomplished on a signature verification basis using whatever means of transportation is available. Used parachutes and other fabric items will be tagged in accordance with DA PAM 738-751, and rolled, folded, or placed loosely in a parachute pack, deployment bag, or other suitable container, as required. Unused parachutes will be transported in original shipping containers. During shipment, every effort will be made to protect parachute from weather elements, dust, dirt, oil, grease, and acids. Vehicles used to transport parachutes will be inspected to ensure the items are protected from the previously cited material damaging conditions.

Other Shipping Instructions

Parachutes destined for domestic or overseas shipment will be packaged and marked in accordance with AR 700-15. Shipment of parachutes will be accomplished in accordance with TM 10-1670-201-23.

Accordion Folding/Rigger Rolling

Accordion Folding. Personnel parachute canopy assemblies that are not packed for use should be accordion folded prior to entry into storage. To accordion fold a parachute canopy assembly perform the following:

1. Place the parachute canopy in proper layout under partial tension and dress the outside edges of both gore groups.
2. Fold the left group of gores over the right group. Release the tension.

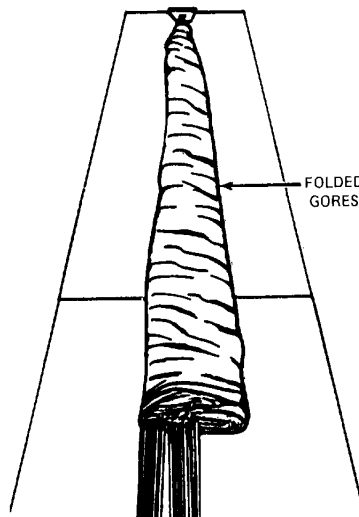

Figure 1. Folding of Gore Groups Completed.

3. Daisy chain the suspension lines and S-fold the chained lines on top of the applicable parachute pack.

PREPARATION FOR STORAGE OR SHIPMENT - CONTINUED

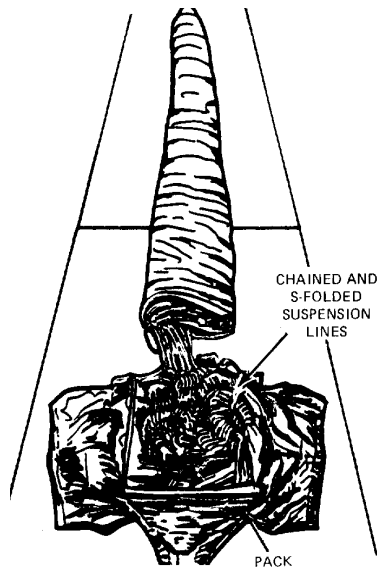

Figure 2. Suspension Lines Stowed on Pack.

4. Place the lower end of the canopy on top of the S-folded suspension lines and locate the lower edge of the canopy skirt at the lower end of the pack.
5. Accordion fold the remaining canopy length neatly on top of the canopy lower end. Turn the canopy vent under the last fold.

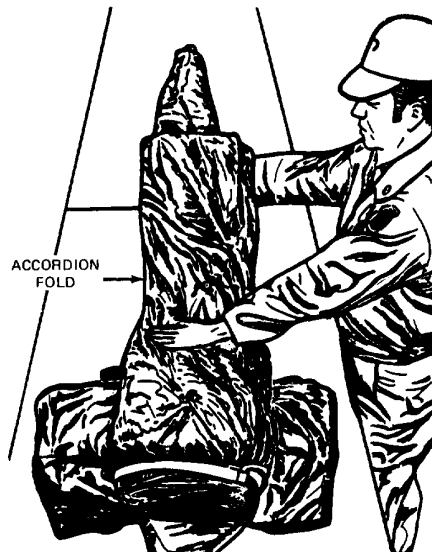

Figure 3. Accordion Folding the Canopy.

PREPARATION FOR STORAGE OR SHIPMENT - CONTINUED

6. Temporarily secure the folded canopy to the pack tray with available webbing or pack components.
7. Upon completion of the accordion folding process, place the folded parachute assembly in a suitable type container for storage.



Figure 4. Folded Canopy Secured.

END OF TASK

PREPARATION FOR STORAGE OR SHIPMENT - CONTINUED

Rigger Rolling. Personnel parachute assemblies will be rigger rolled prior to being sent to, or returned from, a parachute repair activity, for ease of handling and to prevent suspension line entanglement. Rigger roll a parachute as follows:

1. Place the parachute in proper layout and apply partial tension.
2. Grasp the right and left suspension line groups. Using a fast circular motion, flip each of the two gore groups up and to the center radial seam. Tighten each gore group roll by hand; bring both rolled gore groups together at the center radial seam.

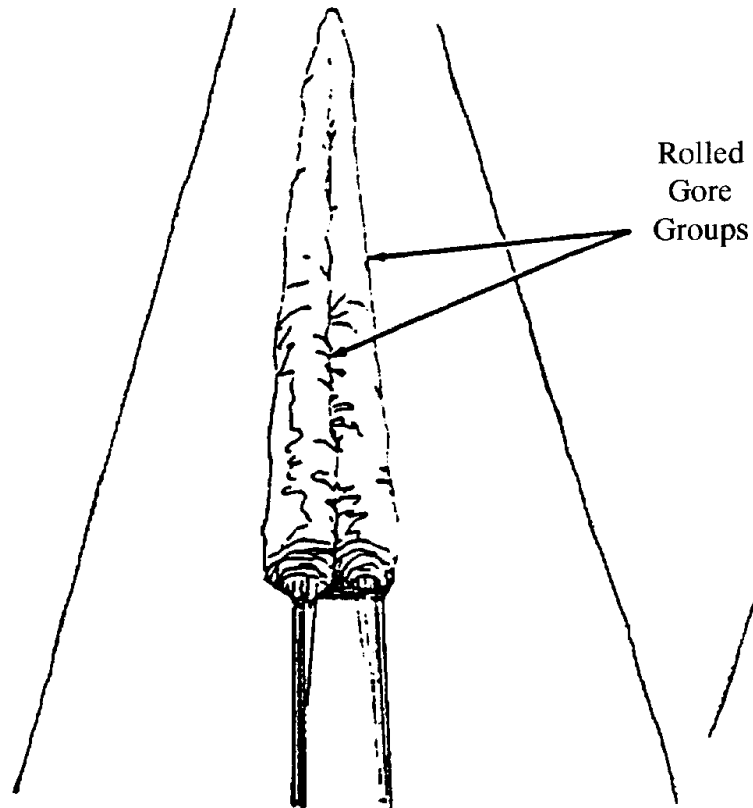

Figure 5. Rigger Rolling.

3. Release tension and disconnect the canopy vent from the vent-attaching device.
4. Fold the canopy vent down between the rolled gore groups to a point within 18 inches of the canopy skirt lower edge.

PREPARATION FOR STORAGE OR SHIPMENT - CONTINUED

- Beginning at the folded upper end of the canopy, roll the canopy tightly toward the canopy skirt. Ensure the width of the rolled canopy does not exceed the width of the applicable parachute pack tray.

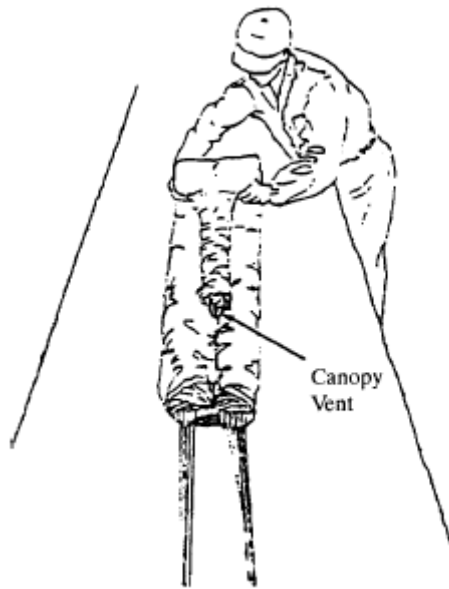

Figure 6. Roll the Canopy tightly toward the Canopy Skirt.

- Continue rolling the canopy toward the lower end of the suspension lines and risers. If applicable, locate the lines and riser webbing around the center of the roll.

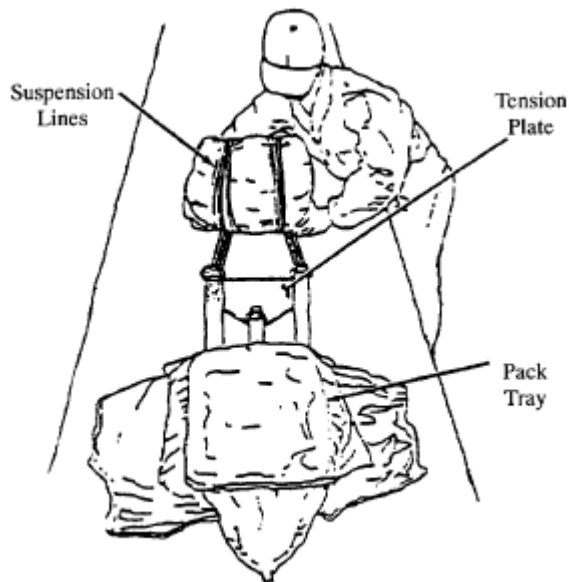

Figure 7. Continue Rolling Canopy toward Lower End of Suspension Lines and Risers.

PREPARATION FOR STORAGE OR SHIPMENT - CONTINUED

7. As applicable, disconnect the suspension lines/risers from the attaching device and place the rolled canopy assembly on top of the pack tray.
8. Secure the rolled canopy assembly within the confines of the pack tray, using either the straps or webbing of the pack tray, or a length of suitable type cord.

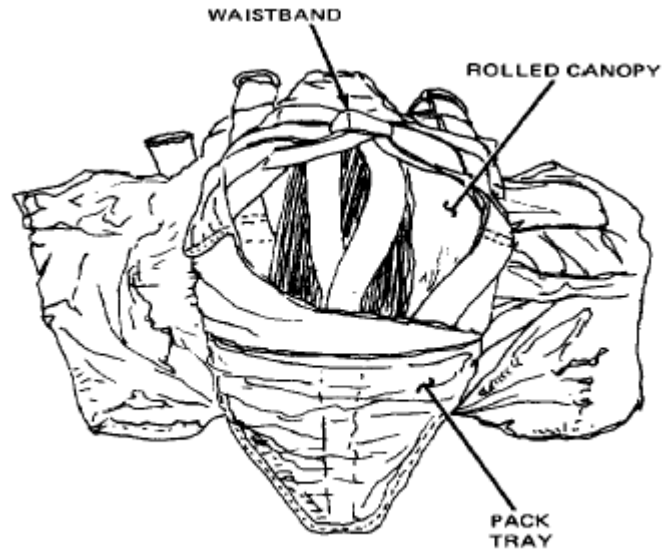

Figure 8. Secure Rolled Canopy Assembly within Pack Tray.

END OF TASK

END OF WORK PACKAGE

FIELD MAINTENANCE

ILLUSTRATED LIST OF MANUFACTURED ITEMS

ILLUSTRATED LIST OF MANUFACTURED ITEMS INTRODUCTION

Scope

This work package includes complete instructions for making items authorized to be manufactured or fabricated at the FIELD MAINTENANCE level.

How to Use the Index of Manufactured Items

A part number index in alphanumeric order is provided for cross-referencing the part number of the item to be manufactured to the page which covers fabrication criteria.

Explanation of the Illustrations of Manufactured Items

All instructions needed by maintenance personnel to manufacture the item are included on the illustrations. All bulk materials needed for manufacture of an item are listed by part number or specification number in a tabular list on the illustration.

ILLUSTRATED LIST OF MANUFACTURED ITEMS INDEX

Table 1. Illustrated List of Manufactured Items Index.

Item Name / Part Number	Item Description	Reference
Spring Compression Test Tube	Used to test T-11R Ejector Spring.	WP 0084-2
Spring Compression Test Tube 32-Pound Weight	Used to test T-11R Ejector Spring.	WP 0084-3
Reserve Ripcord Pull Handle Cuff	Used for pull test on T-11R Ripcord.	WP 0084-6
Suspension Line Attaching Loop / 11-1-7106-7	T-11 Main Canopy	WP 0032
Arm Panel Sections / 11-1-7106	T-11 Main Canopy	WP 0027
Center Section / 11-1-7107	T-11 Main Canopy	WP 0028
Bridle Attachment Assembly / 11-1-7107-6	T-11 Main Canopy	WP 0035
Packing Loop / 11-1-7107-5	T-11 Main Canopy-Center Section	WP 0078
Packing Tab / 11-1-7107-4	T-11 Main Canopy-Center Section	WP 0079
Inner Static Line Stow Bar / 11-1-7130-5	T-11 Main Pack Tray	WP 0038
Outer Static Line Stow Bar / 11-1-7721-11	T-11 Main Pack Tray	WP 0038
Static Line Slack Retainer / 11-1-7129-6	T-11 Main Pack Tray	WP 0038
Tie-Down Loop / 11-1-7063-5	T-11 Main Deployment Bag (body)	WP 0076

ILLUSTRATED LIST OF MANUFACTURED ITEMS INDEX - CONTINUED**Table 1. Illustrated List of Manufactured Items Index. - Continued**

Item Name / Part Number	Item Description	Reference
Tie-Down Loop / 11-1-7145-3	T-11 Main Deployment Bag (protector flap)	WP 0076
Packing Frame Support Loop / 11-1-7101-1	Part of T-11 Deployment Bag Packing Frame	WP 0084-6
Keeper Assembly, Excess Webbing / 11-1-7153-1	Part of T-11 Harness Assembly	WP 0051
Apex Vent Bridal Loop / 11-1-7111-7	Reserve Parachute, T-11R	WP 0062
Loop, Suspension Line / 11-1-7111-4	Reserve Parachute, T-11R	WP 0076
Fastener, Loop / 11-1-7729-2	Loop tape at bottom reserve risers (holds risers in reserve pack tray)	WP 0065
Fastener, Loop / 11-1-7729-8	Loop tape at top of reserve risers (holds risers together during pack)	WP 0065
Fastener, Hook / 11-1-7729-7	Hook tape at top of reserve risers (holds risers together during pack)	WP 0065
Fastener, Hook / 11-1-7743-5	Hook tape (Inside of reserve pack tray)	WP 0066

SPRING COMPRESSION TEST TUBE MANUFACTURE**CAUTION**

Based on the manufacturer, the inside diameter of the PVC pipe may vary. Be sure to purchase the PVC pipe prior to the fabrication of the 32-pound weight. Slight dimensional modifications to the PVC pipe may be necessary to ensure the 32-pound weight fits inside the PVC pipe. Failure to procure the PVC pipe first may result in the improper fit of the 25-pound weight.

INITIAL SETUP:**Tools and Special Tools**

Drill, Electric, 5/8-in Chuck
Welding Machine

Materials/Parts

Pipe, PVC, 8-inch
Sheet Metal, Aluminum, 1/8-inch Thick
Rod, Aluminum, 3/8-inch Diameter
Weighted Material
Test Set, Spring Compression
(Composition of assembled components listed above.)

SPRING COMPRESSION TEST TUBE MANUFACTURE – CONTINUED

Fabricate the test tube as follows:

1. Acquire a piece of pipe (PVC pipe) with an inside dimension of 8 inches (minimum). The outside dimensions should be around 8½ inches.
2. Cut the pipe to a length of 36 inches and determine a top and bottom.

NOTE

The purpose of the inspection slot is to view the spring when compressed under the 32-pound weight.

3. Install the inspection slot by placing a mark 1½ inches up from the bottom. Make an additional mark 7½ inches up from the bottom.
4. Cut a 1-inch wide slot from the 1½ inch mark to the 7½ inch mark. The top and bottom slots are rounded, but this is not required.

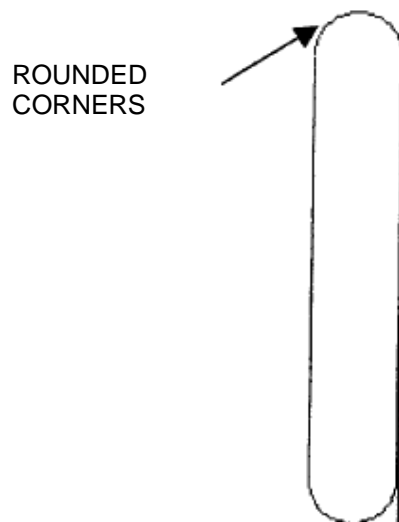

Figure 1. Viewing Slot.

SPRING COMPRESSION TEST TUBE 32-LB WEIGHT MANUFACTURE

Fabricate the 32-lb weight as follows:

1. From $\frac{1}{8}$ -inch thick aluminum sheet metal, cut one piece 24 inches by 11 inches and two circular pieces $7\frac{5}{8}$ inches in diameter.
2. From a $\frac{3}{8}$ -inch diameter aluminum rod, cut one piece $7\frac{5}{8}$ inches in length.

NOTE

The rectangular piece will form the body of the 32-pound weight; the $\frac{3}{8}$ -inch diameter rod will form the carrying handle, and the two circular disks will form the top and bottom of the cylinder used to retain the weight material placed inside.

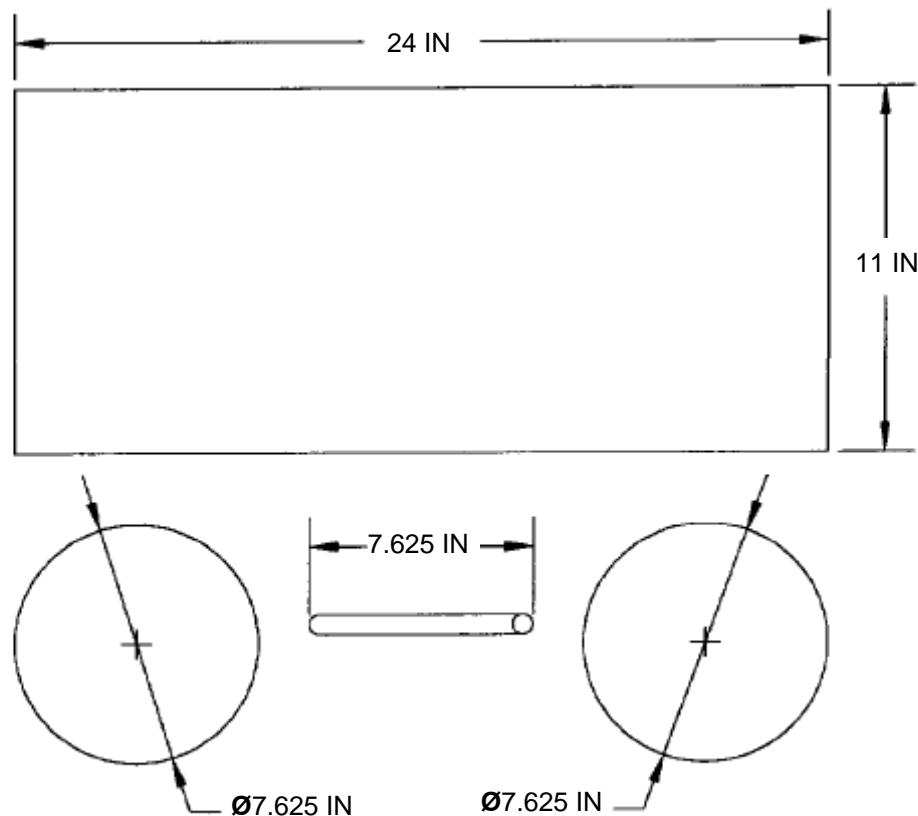

Figure 2. Fabricating 32-Pound Weight.

3. Form the rectangular piece to conform to the circumference of the two circular disks (Figure 2).
4. Position the top disk 2 inches down from the top of the rectangular piece when the weld is made to join the pieces. This allows room for the installation of the $7\frac{5}{8}$ inch long, $\frac{3}{8}$ -inch diameter aluminum rod, which will be used as the carrying handle.

SPRING COMPRESSION TEST TUBE 32-LB WEIGHT MANUFACTURE – CONTINUED

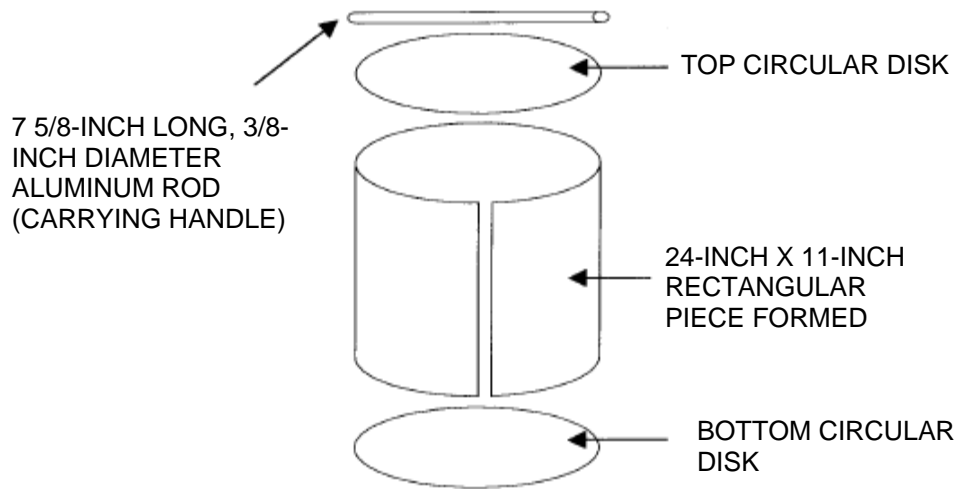

Figure 3. Fabricating 32 Pound Weight.

5. Position the bottom disk flush with the bottom of the rectangular piece when the weld is made.
6. Position the carrying handle even with the top of the rectangular piece and weld in place.

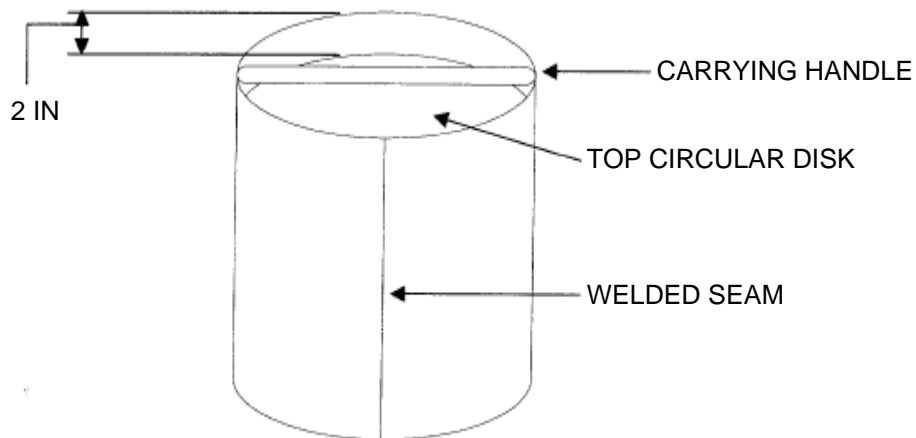

Figure 4. Fabricating 32-Pound Weight.

NOTE

The overall weight when complete will not exceed 32 pounds. Weight higher than 25 pounds will result in unnecessary replacement of ejector spring.

7. Drill a hole in the top disk. Do not make the diameter of the hole any larger than needed to fill the weight.
8. Suggested materials for weight include BBs, birdshot, or sand. Fill the cylinder to no less than 24 lbs, 12-oz and no more than 24 lbs, 15-oz.
9. Permanently close the hole ensuring no filter weight loss occurs. Welding the hole closed is recommended.

HAND CUFF MANUFACTURE

Fabricate a reserve ripcord pull handle cuff in accordance with the illustration below. Make from 8.2 oz cotton sateen cloth. Use a number 3 spur grommet.

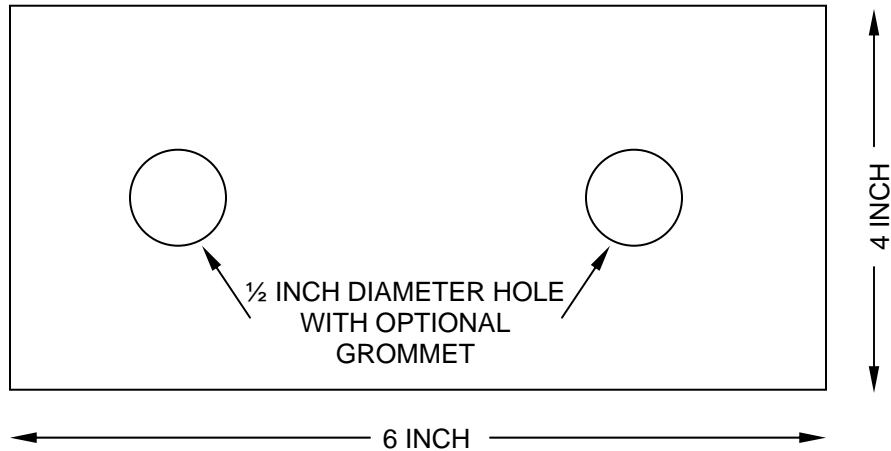

Figure 5. Reserve Ripcord Pull Handle Cuff.

PACKING FRAME SUPPORT LOOP MANUFACTURE

Fabricate suspension loop in accordance with the illustration below. Make from natural type II fibrous polyester cord cut 14 inches in length.



Figure 6. Packing Frame Support Loop.

END OF TASK

END OF WORK PACKAGE

CHAPTER 4

PARTS INFORMATION
FOR
T-11 PERSONNEL PARACHUTE SYSTEM

FIELD MAINTENANCE

REPAIR PARTS AND SPECIAL TOOLS LIST (RPSTL)

INTRODUCTION

SCOPE

This RPSTL lists and authorizes spares and repair parts; special tools; special test, measurement, and diagnostic equipment (TMDE); and other special support equipment required for performance of field maintenance of the T-11 Personnel Parachute System. It authorizes the requisitioning, issue, and disposition of spares, repair parts, and special tools as indicated by the source, maintenance, and recoverability (SMR) codes.

GENERAL

In addition to the Introduction work package, this RPSTL is divided into the following work packages.

1. Repair Parts List Work Packages. Work packages containing lists of spares and repair parts authorized by this RPSTL for use in the performance of maintenance. These work packages also include parts which must be removed for replacement of the authorized parts. Parts lists are composed of functional groups in ascending alphanumeric sequence, with the parts in each group listed in ascending figure and item number sequence. Sending units, brackets, filters, and bolts are listed with the component they mount on. Bulk materials are listed by item name in FIG. BULK at the end of the work packages. Repair parts kits are listed at the end of the individual work packages. Repair parts for repairable special tools are also listed in a separate work package. Items listed are shown on the associated illustrations.
2. Special Tools List Work Packages. Work packages containing lists of special tools, special TMDE, and special support equipment authorized by this RPSTL (as indicated by Basis of Issue (BOI) information in the DESCRIPTION AND USABLE ON CODE (UOC) column). Tools that are components of common tool sets and/or Class VII are not listed.
3. Cross-Reference Indexes Work Packages. There are two cross reference index work packages in this RPSTL: the National Stock Number (NSN) Index work package, and the Part Number (P/N) Index work package. The National Stock Number Index work package refers you to the figure and item number. The Part Number Index work package refers you to the figure and item number.

EXPLANATION OF COLUMNS IN THE REPAIR PARTS LIST AND SPECIAL TOOLS LIST WORK PACKAGES

ITEM NO. (Column (1)). Indicates the number used to identify items called out in the illustration.

SMR CODE (Column (2)). The SMR code containing supply/requisitioning information, maintenance level authorization criteria, and disposition instruction, as shown in the following breakout:

TABLE 1. SMR Code.

Source Code	Maintenance Code	Recoverability Code
XX	XX	X
1st two positions:	3rd position:	5th position:
How to get an item.	Who can install, replace, or use the item.	Who determines disposition action on unserviceable items.
	4th position:	
	Who can do complete repair* on the item.	

*Complete Repair: Maintenance capacity, capability, and authority to perform all corrective maintenance tasks of the "Repair" function in a use/user environment in order to restore serviceability to a failed item.

EXPLANATION OF COLUMNS IN THE REPAIR PARTS LIST AND SPECIAL TOOLS LIST WORK PACKAGES – CONTINUED

Source Code. The source code tells you how you get an item needed for maintenance, repair, or overhaul of an end item/equipment. Explanations of source codes follow:

<u>Source Code</u>	<u>Application/Explanation</u>
PA	
PB	
PC	NOTE
PD	Items coded PC are subject to deterioration.
PE	Stock items; use the applicable NSN to
PF	requisition/request items with these source codes. They
PG	are authorized to the level indicated by the code entered
PH	in the 3rd position of the SMR code.
PR	
PZ	
KD	Items with these codes are not to be
KF	requested/requisitioned individually. They are part of a
KB	kit which is authorized to the maintenance level indicated
	in the 3rd position of the SMR code. The complete kit
	must be requisitioned and applied.
MO-Made at field/AVUM level	Items with these codes are not to be
MF-Made at DS/AVIM level	requisitioned/requested individually. They must be made
MH-Made at GS level	from bulk material which is identified by the part number
ML-Made at SRA	in the DESCRIPTION AND USABLE ON CODE
MD-Made at depot	(UOC) column and listed in the bulk material group work
MG-Navy only	package of the RPSTL. If the item is authorized to you
	by the 3rd position code of the SMR code, but the source
	code indicates it is made at higher level, order the item
	from the higher level of maintenance.
AO-Assembled by	Items with these codes are not to be
field/AVUM level	requested/requisitioned individually. The parts that make
AF-Assembled by	up the assembled item must be requisitioned or
DS/AVIM level	fabricated and assembled at the level of maintenance
AH-Assembled by GS level	indicated by the source code. If the 3rd position of the
AL-Assembled by SRA	SMR code authorizes you to replace the item, but the
AD-Assembled by depot	source code indicates the item is assembled at a higher
AG-Navy only	level, order the item from the higher level of
	maintenance.
XA	Do not requisition an "XA" coded item. Order the next
	higher assembly.(Refer to NOTE below.)
XB	If an item is not available from salvage, order it using the
	CAGEC and part number.
XC	Installation drawings, diagrams, instruction sheets, field
	service drawings; identified by manufacturer's part
	number.
XD	Item is not stocked. Order an XD-coded item through
	normal supply channels using the CAGEC and part
	number given, if no NSN is available.

EXPLANATION OF COLUMNS IN THE REPAIR PARTS LIST AND SPECIAL TOOLS LIST WORK PACKAGES – CONTINUED

NOTE

Cannibalization or controlled exchange, when authorized, may be used as a source of supply for items with the above source codes except for those items source coded "XA" or those aircraft support items restricted by requirements of AR 750-1.

Maintenance Code. Maintenance codes tell you the level(s) of maintenance authorized to use and repair support items. The maintenance codes are entered in the third and fourth positions of the SMR code as follows:

Third Position. The maintenance code entered in the third position tells you the lowest maintenance level authorized to remove, replace, and use an item. The maintenance code entered in the third position will indicate authorization to the following levels of maintenance:

Maintenance Code

Application/Explanation

O* -	Field level/AVUM maintenance can remove, replace, and use the item.
F -	Direct support/AVIM maintenance can remove, replace, and use the item.
H -	General support maintenance can remove, replace, and use the item.
L -	Specialized repair activity can remove, replace, and use the item.
G -	Afloat and ashore intermediate maintenance can remove, replace, and use the item (Navy only)
K -	Contractor facility can remove, replace, and use the item
Z -	Item is not authorized to be removed, replace, or used at any maintenance level
D -	Depot can remove, replace, and use the item.

*NOTE - Army may use C in the third position. However, for joint service publications, Army will use O.

Fourth Position. The maintenance code entered in the fourth position tells you whether or not the item is to be repaired and identifies the lowest maintenance level with the capability to do complete repair (perform all authorized repair functions).

NOTE

Some limited repair may be done on the item at a lower level of maintenance, if authorized by the Maintenance Allocation Chart (MAC) and SMR codes.

Maintenance Code

Application/Explanation

O -	Field/AVUM is the lowest level that can do complete repair of the item.
F -	Direct support/AVIM is the lowest level that can do complete repair of the item.
H -	General support is the lowest level that can do complete repair of the item.
L -	Specialized repair activity (enter specialized repair activity designator) is the lowest level that can do complete repair of the item.
D -	Depot is the lowest level that can do complete repair of the item.
G -	Both afloat and ashore intermediate levels are capable of complete repair of item. (Navy only)
K -	Complete repair is done at contractor facility
Z -	Nonrepairable. No repair is authorized.
B -	No repair is authorized. No parts or special tools are authorized for maintenance of "B" coded item. However, the item may be reconditioned by adjusting, lubricating, etc., at the user level.

EXPLANATION OF COLUMNS IN THE REPAIR PARTS LIST AND SPECIAL TOOLS LIST WORK PACKAGES – CONTINUED

Recoverability Code. Recoverability codes are assigned to items to indicate the disposition action on unserviceable items. The recoverability code is shown in the fifth position of the SMR code as follows:

Recoverability

<u>Code</u>	<u>Application/Explanation</u>
Z -	Nonrepairable item. When unserviceable, condemn and dispose of the item at the level of maintenance shown in the third position of the SMR code.
O -	Reparable item. When uneconomically repairable, condemn and dispose of the item at the field level.
F -	Reparable item. When uneconomically repairable, condemn and dispose of the item at the direct support level.
H -	Reparable item. When uneconomically repairable, condemn and dispose of the item at the general support level.
D -	Reparable item. When beyond lower level repair capability, return to depot. Condemnation and disposal of item are not authorized below depot level.
L -	Reparable item. Condemnation and disposal not authorized below Specialized Repair Activity (SRA).
A -	Item requires special handling or condemnation procedures because of specific reasons (such as precious metal content, high dollar value, critical material, or hazardous material). Refer to appropriate manuals/directives for specific instructions.
G -	Filed level repairable item. Condemn and dispose at either afloat or ashore intermediate levels. (Navy only)
K -	Reparable item. Condemnation and disposal to be performed at contractor facility

NSN (Column (3)). The NSN for the item is listed in this column.

CAGEC (Column (4)). The Commercial and Government Entity Code (CAGEC) is a five-digit code which is used to identify the manufacturer, distributor, or Government agency/activity that supplies the item.

PART NUMBER (Column (5)). Indicates the primary number used by the manufacturer (individual, company, firm, corporation, or Government activity), which controls the design and characteristics of the item by means of its engineering drawings, specifications, standards, and inspection requirements to identify an item or range of items.

NOTE

When you use an NSN to requisition an item, the item you receive may have a different part number from the number listed.

DESCRIPTION AND USABLE ON CODE (UOC) (Column (6)). This column includes the following information:

1. The federal item name, and when required, a minimum description to identify the item.
 2. Part numbers of bulk materials are referenced in this column in the line entry to be manufactured or fabricated.
 3. Hardness Critical Item (HCI). A support item that provides the equipment with special protection from electromagnetic pulse (EMP) damage during a nuclear attack.
 4. The statement END OF FIGURE appears just below the last item description in column (6) for a given figure in both the repair parts list and special tools list work packages.
- QTY (Column (7)). The QTY (quantity per figure) column indicates the quantity of the item used in the breakout shown on the illustration/figure, which is prepared for a functional group, sub functional group, or an assembly. A "V" appearing in this column instead of a quantity indicates that the quantity is variable and quantity may change from application to application.

EXPLANATION OF CROSS-REFERENCE INDEXES WORK PACKAGES FORMAT AND COLUMNS

1. National Stock Number (NSN) Index Work Package. NSNs in this index are listed in National Item Identification Number (NIIN) sequence.

STOCK NUMBER Column. This column lists the NSN in NIIN sequence. The NIIN consists of the last nine digits of the NSN. When using this column to locate an item, ignore the first four digits of the NSN. However, the complete NSN should be used when ordering items by stock number. For example, if the NSN is 5385-01-574-1476, the NIIN is 01-574-1476.

FIG. Column. This column lists the number of the figure where the item is identified/located. The figures are in numerical order in the repair parts list and special tools list work packages.

ITEM Column. The item number identifies the item associated with the figure listed in the adjacent FIG. column. This item is also identified by the NSN listed on the same line.

2. Part Number (P/N) Index Work Package. Part numbers in this index are listed in ascending alphanumeric sequence (vertical arrangement of letter and number combinations which places the first letter or digit of each group in order A through Z, followed by the numbers 0 through 9 and each following letter or digit in like order).

PART NUMBER Column. Indicates the part number assigned to the item.

FIG. Column. This column lists the number of the figure where the item is identified/located in the repair parts list and special tools list work packages.

ITEM Column. The item number is the number assigned to the item as it appears in the figure referenced in the adjacent figure number column."

SPECIAL INFORMATION

UOC. The UOC appears in the lower left corner of the Description Column heading. Usable on codes are shown as "UOC:..." in the Description Column (justified left) on the first line under the applicable item/nomenclature. Uncoded items are applicable to all models. Identification of the UOCs used in the RPSTL are:

<u>Code</u>	<u>Used On</u>
FWG	Parachute, System, Personnel, T-11

Fabrication Instructions. Bulk materials required to manufacture items are listed in the bulk material functional group of this RPSTL. Part numbers for bulk material are also referenced in the Description Column of the line item entry for the item to be manufactured/fabricated. Detailed fabrication instructions for items source coded to be manufactured or fabricated are found in WP0085 of this technical manual.

Index Numbers. Items which have the word BULK in the figure column will have an index number shown in the item number column. This index number is a cross-reference between the NSN / Part Number (P/N) Index work packages and the bulk material list in the repair parts list work package.

Illustrations List. The illustrations in this RPSTL contain field authorized items. Illustrations published in (enter applicable TM number for the higher maintenance level RPSTL, e.g., for direct support, general support, etc.) that contain field authorized items also appear in this RPSTL. The tabular list in the repair parts list work package contains only those parts coded "O" in the third position of the SMR code, therefore, there may be a break in the item number sequence.

HOW TO LOCATE REPAIR PARTS

1. When NSNs or Part Numbers Are Not Known.

First. Using the table of contents, determine the assembly group to which the item belongs. This is necessary since figures are prepared for assembly groups and subassembly groups, and lists are divided into the same groups.

Second. Find the figure covering the functional group or the sub functional group to which the item belongs.

Third. Identify the item on the figure and note the number(s).

Fourth. Look in the repair parts list work packages for the figure and item numbers. The NSNs and part numbers are on the same line as the associated item numbers.

2. When NSN Is Known.

First. If you have the NSN, look in the STOCK NUMBER column of the NSN index work package. The NSN is arranged in NIIN sequence. Note the figure and item number next to the NSN.

Second. Turn to the figure and locate the item number. Verify that the item is the one you are looking for.

3. When Part Number Is Known.

First. If you have the part number and not the NSN, look in the PART NUMBER column of the part number index work package. Identify the figure and item number.

Second. Look up the item on the figure in the applicable repair parts list work package.

END OF WORK PACKAGE

PARTS INFORMATION

T-11 PERSONNEL PARACHUTE SYSTEM

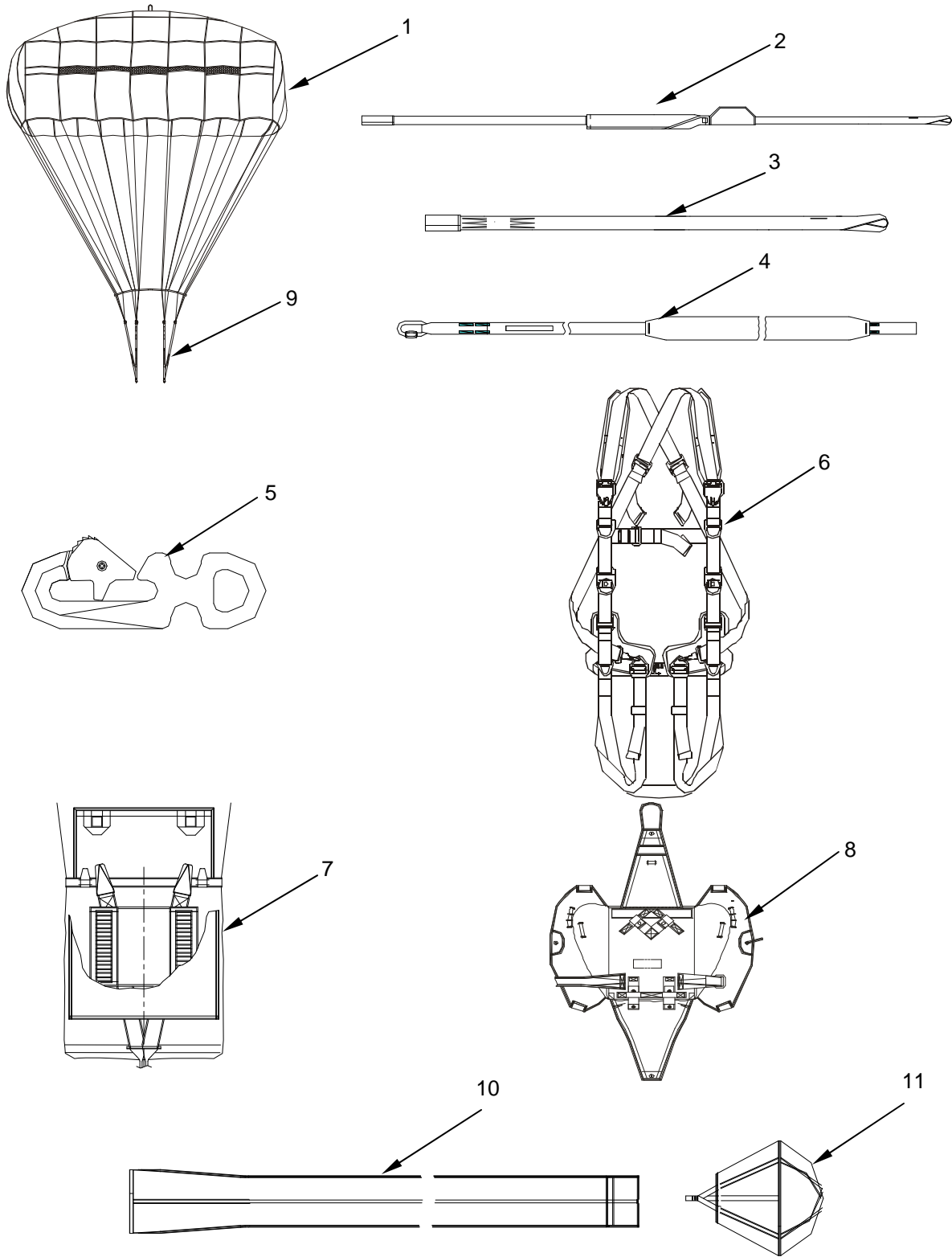

Figure 1. T-11 Personnel Parachute System (Sheet 1 of 2).

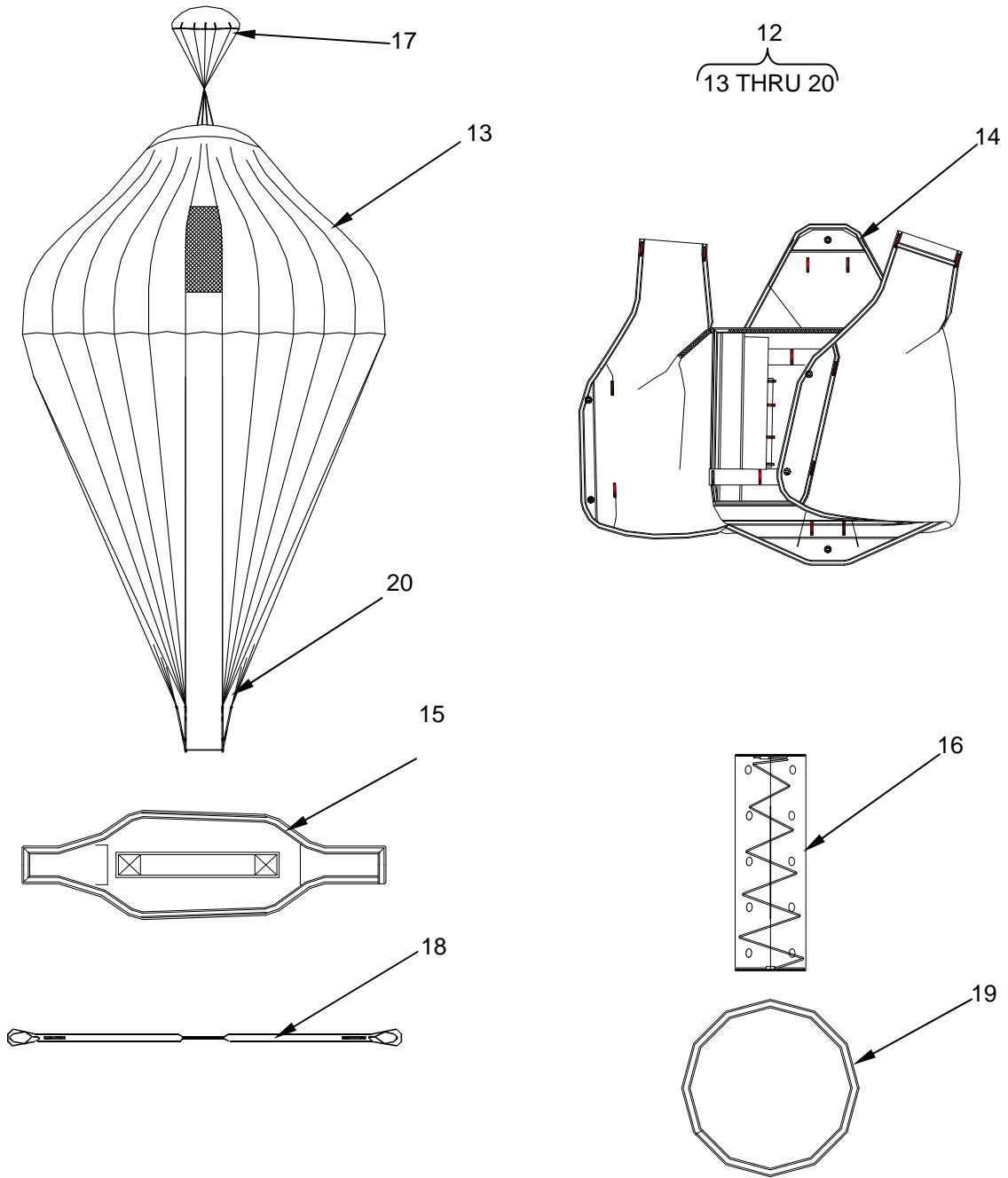

Figure 1. T-11 Personnel Parachute System (Sheet 2 of 2).

(1) ITEM NO.	(2) SMR CODE	(3) NSN	(4) CAGEC	(5) PART NUMBER	(6) DESCRIPTION AND USABLE ON CODE (UOC)	(7) QTY
GROUP 00						
FIG. 1 T-11 PERSONNEL PARACHUTE SYSTEM						
1	XAOOO		81337	11-1-7050-1	T-11 MAIN PARACHUTE ASSEMBLY	1
2	PAOZZ	1670-01-535-2252	81337	11-1-6993-3	STATIC LINE, MODIFIED, PERSONNEL	1
3	PAOZZ	1670-01-476-3130	81337	11-1-6993-2	STATIC LINE, EXTENSION PERSONNEL PARACHUTE	1
4	PAOZZ	1670-01-567-2208	81337	11-1-7062-1	BRIDLE ASSY, T-11 MAIN (WITH LINK CONNECTOR)	1
5	PAOZZ	1670-01-476-3142	81337	11-1-6991-1	STATIC LINE SNAP	1
6	PAOOO	1670-01-535-2233	81337	11-1-7722-1	HARNESS ASSY., T-11	1
7	PAOOO	1670-01-567-4708	81337	11-1-7063-1	DEPLOYMENT BAG ASSY	1
8	PAOOO	1670-01-567-4709	81337	11-1-7720-1	PACK TRAY, T-11 MAIN	1
9	PAOOO	1670-01-567-7296	81337	11-1-7719-1	RISER SET, T-11MAIN	1
10	PAOOO	1670-01-567-2211	81337	11-1-7061-1	DEPLOYMENT SLEEVE ASSY	1
11	PAOOO	1670-01-567-2210	81337	11-1-7060-1	DROGUE ASSY, T-11MAIN	1
12	PCOOO	1670-01-535-2248	81337	11-1-7730-1	RESERVE PARACHUTE ASSY, T-11R	1
13	XAOOO		81337	11-1-7052-1	CANOPY ASSY., T-11 RESERVE	1
14	PAOOO	1670-01-535-2254	81337	11-1-7726-1	RESERVE PACK TRAY ASSY, T-11	1
15	PAOZZ	1670-01-535-2250	81337	11-1-7058-1	RESERVE RIPCORD ASSY, T-11R	1
16	PAOZZ	1670-01-535-2246	81337	11-1-7065-1	EJECTOR SPRING ASSY, T-11R	1
17	PAOZZ	1670-01-535-2251	81337	11-1-7064-1	EXTRACTOR ASSY, T-11R	1
18	PAOZZ	1670-01-535-2247	81337	11-1-7067-1	CLOSING LOOP ASSY., T-11R	1
19	PAOZZ	1670-01-535-4257	81337	11-1-7069-1	CAP ASSY., T-11R, PROTECTION	1
20	PAOZZ	1670-01-535-2255	81337	11-1-7729-1	RISER SET, T-11R	1

END OF FIGURE

PARTS INFORMATION

T-11 MAIN PARACHUTE ASSEMBLY

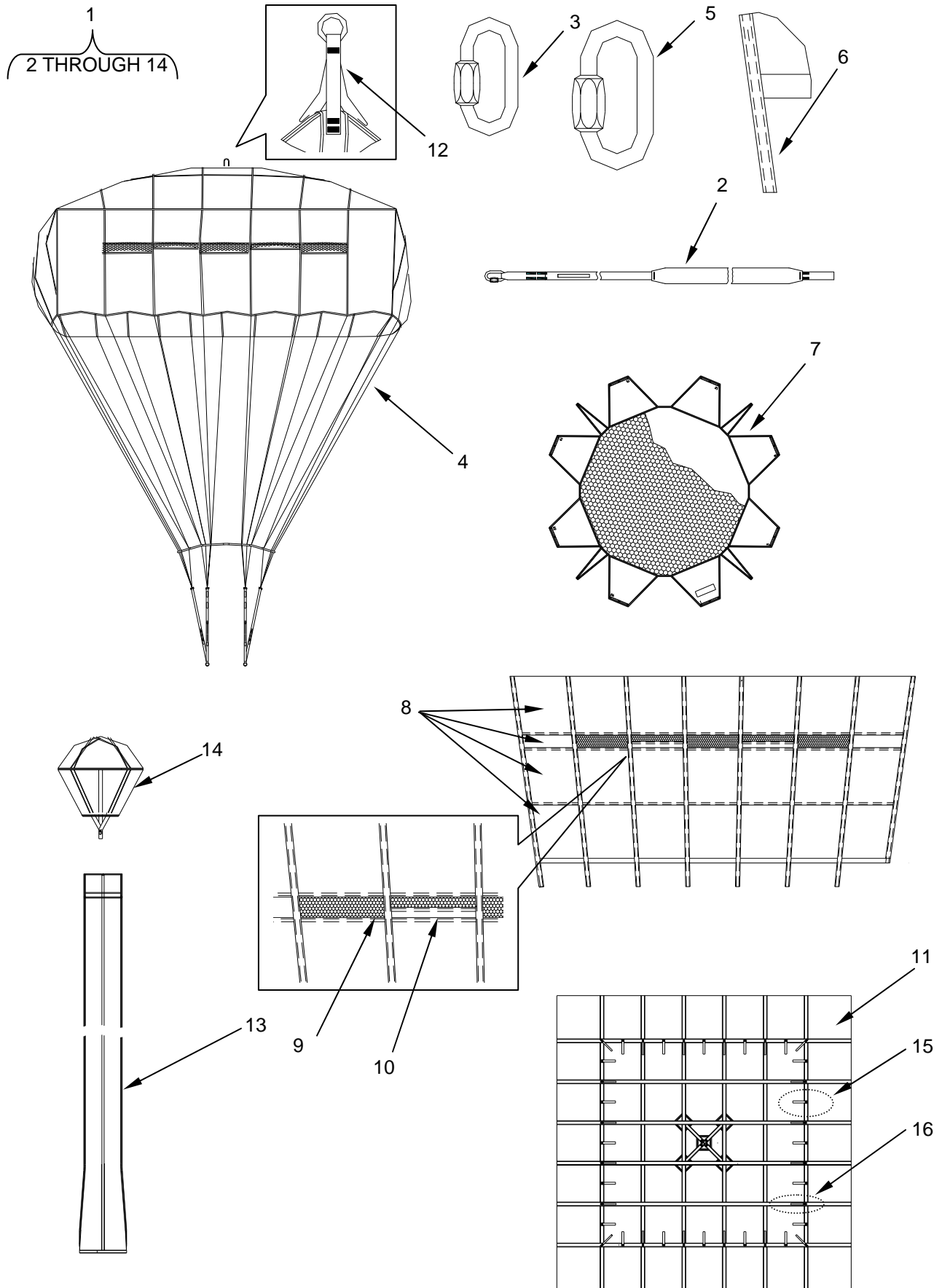

Figure 2. T-11 Main Parachute Assembly.

(1) ITEM NO.	(2) SMR CODE	(3) NSN	(4) CAGEC	(5) PART NUMBER	(6) DESCRIPTION AND USABLE ON CODE (UOC)	(7) QTY
GROUP 01						
FIG. 2 T-11 MAIN PARACHUTE ASSEMBLY						
1	XAOOO		81337	11-1-7051-1	T-11 MAIN PARACHUTE ASSEMBLY	1
2	PAOZZ	1670-01-567-2208	81337	11-1-7062-1	. BRIDLE ASSEMBLY, T-11 MAIN	1
3	PAOZZ	1670-01-569-2065	63266	11-1-7228-1	. LINK, PARACHUTE, CONNECTOR, (BRIDLE LINE) (SIZE 4)	1
4	PAOZZ	1670-01-567-2209	81337	11-1-7081-1	. ASSEMBLY, SUSPENSION LINE	28
5	PAOZZ	1670-01-330-3691	81337	11-1-7228-3	. LINK, PARACHUTE, CONNECTOR, (MAIN CANOPY SUSPENSION LINE) (SIZE 6)	4
6	MOOZZ		81337	11-1-7106-7	. LOOP, SUSPENSION LINE ATTACHING, MAKE FROM WEBBING, NYLON, TYPE 1, COLOR NATURAL, CAGE 81349, P/N MILW4088 (CUT LENGTH 4-3/4 IN), AND THREAD, NYLON, TYPE I OR II, CLASS A, SIZE E, COLOR NATURAL, CAGE 81348, P/N V-T-295	28
7	PAOZZ	1670-01-567-2205	81337	11-1-7059-1	. SLIDER PANEL, T-11 MAIN	1
8	MOOOO		81337	11-1-7106	. PANEL, ARM ASSEMBLY (ARM ASSEMBLIES 1-4), MAKE FROM CLOTH, PARACHUTE, NYLON, LOW PERMEABILITY, RIPSTOP, TYPE IV, COLOR FG504, CAGE 81349, P/N PIA- C-44378 AND THREAD, NYLON, TYPE I OR II, CLASS A, SIZE E, COLOR NATURAL, CAGE 81348, P/N V-T-295	84
9	PAOOO	1670-01-567-2206	81337	11-1-7581-1	. . MESH PANEL, LARGE, T-11	12
10	PAOOO	1670-01-567-2207	81337	11-1-7581-2	. . MESH PANEL, SMALL, T-11	8
11	MOOOO		81337	11-1-7107	. ASSEMBLY, CENTER SECTION: MAKE FROM CLOTH, PARACHUTE, NYLON, LOW PERMEABILITY, RIPSTOP, TYPE IV, COLOR FG504, CAGE 81349, P/N PIA-C-44378 AND THREAD, NYLON, TYPE I OR II, CLASS A, SIZE E, COLOR NATURAL, CAGE 81348, P/N V-T-295	1
12	MOOOO		81337	11-1-7107-6	. BRIDLE ATTACHMENT ASSEMBLY, MAKE FROM RING NO. 3, CAGE 81337, P/N 11-1-3540, WEBBING, NYLON, TYPE I, CLASS2, 9/16 IN. WIDE, COLOR NATURAL, CAGE 81349, P/N PIA-C-44378 AND THREAD, NYLON, TYPE I OR II, CLASS A, SIZE	1

(1) ITEM NO.	(2) SMR CODE	(3) NSN	(4) CAGEC	(5) PART NUMBER	(6) DESCRIPTION AND USABLE ON CODE (UOC)	(7) QTY
					E, COLOR FG504, CAGE 81348, P/N V-T-295	
13	PAOOO	1670-01-567-2211	81337	11-1-7061-1	DEPLOYMENT SLEEVE ASSEMBLY	1
14	PAOOO	1670-01-567-2210	81337	11-1-7060-1	DROGUE ASSEMBLY, T-11 MAIN	1
15	MOOOO		81337	11-1-7107-5	PACKING LOOP, MAKE FROM WEBBING, NYLON, TYPE I, CLASS 1A, 9/16 IN WIDE, COLOR NATURAL, CAGE 81349, P/N MILW4088 (CUT LENGTH 8 1/4 IN) AND THREAD, NYLON, TYPE I OR II, CLASS A, SIZE E, COLOR FG504, CAGE 81348, P/N V-T-295	20
16	MOOOO		81337	11-1-7107-4	PACKING TAB, MAKE FROM WEBBING, NYLON, TYPE III, CLASS 1A, 3/4 IN WIDE, COLOR FG504, CAGE 81349, P/N MIL-W-4088 (CUT LENGTH SIZE 5 1/2 IN), AND THREAD, NYLON, TYPE I OR II, CLASS A, SIZE E, COLOR NATURAL, CAGE 81348, P/N V-T-295	20

END OF FIGURE

PARTS INFORMATION

T-11 MAIN RISER SET

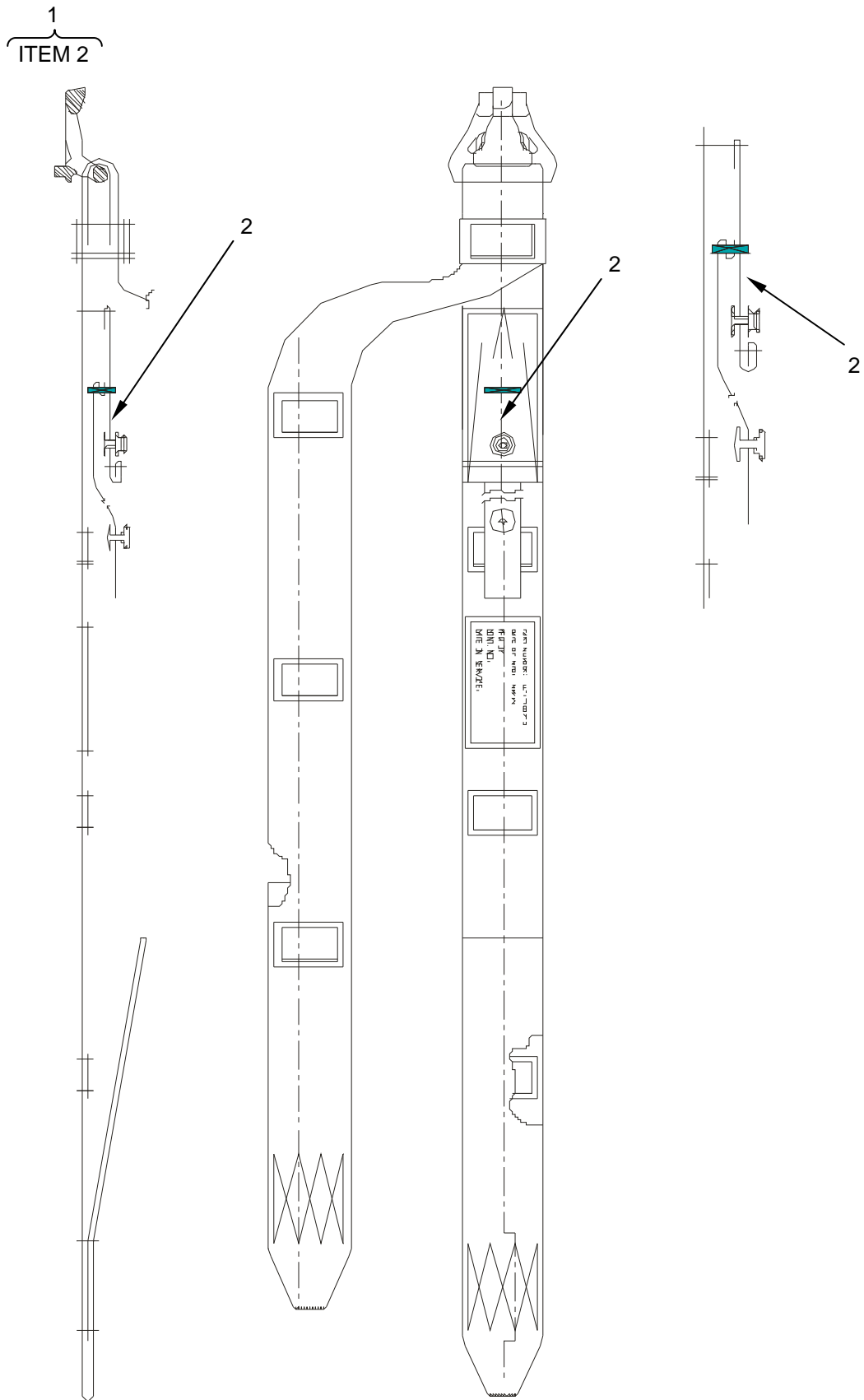

Figure 3. T-11 Main Riser Set.

(1) ITEM NO.	(2) SMR CODE	(3) NSN	(4) CAGEC	(5) PART NUMBER	(6) DESCRIPTION AND USABLE ON CODE (UOC)	(7) QTY
GROUP 02						
FIG. 3 T-11 MAIN RISER SET						
1	PAOZZ	1670-01-567-7296	81337	11-1-7719-1	RISER SET, T-11 MAIN	1
2	PAOZZ	1670-01-535-2229	81337	11-1-7414-1	. POCKET, LOG RECORD, NYLON, TYPE III, CLASS 3, COLOR FG504	1
END OF FIGURE						

PARTS INFORMATION

MAIN PACK TRAY

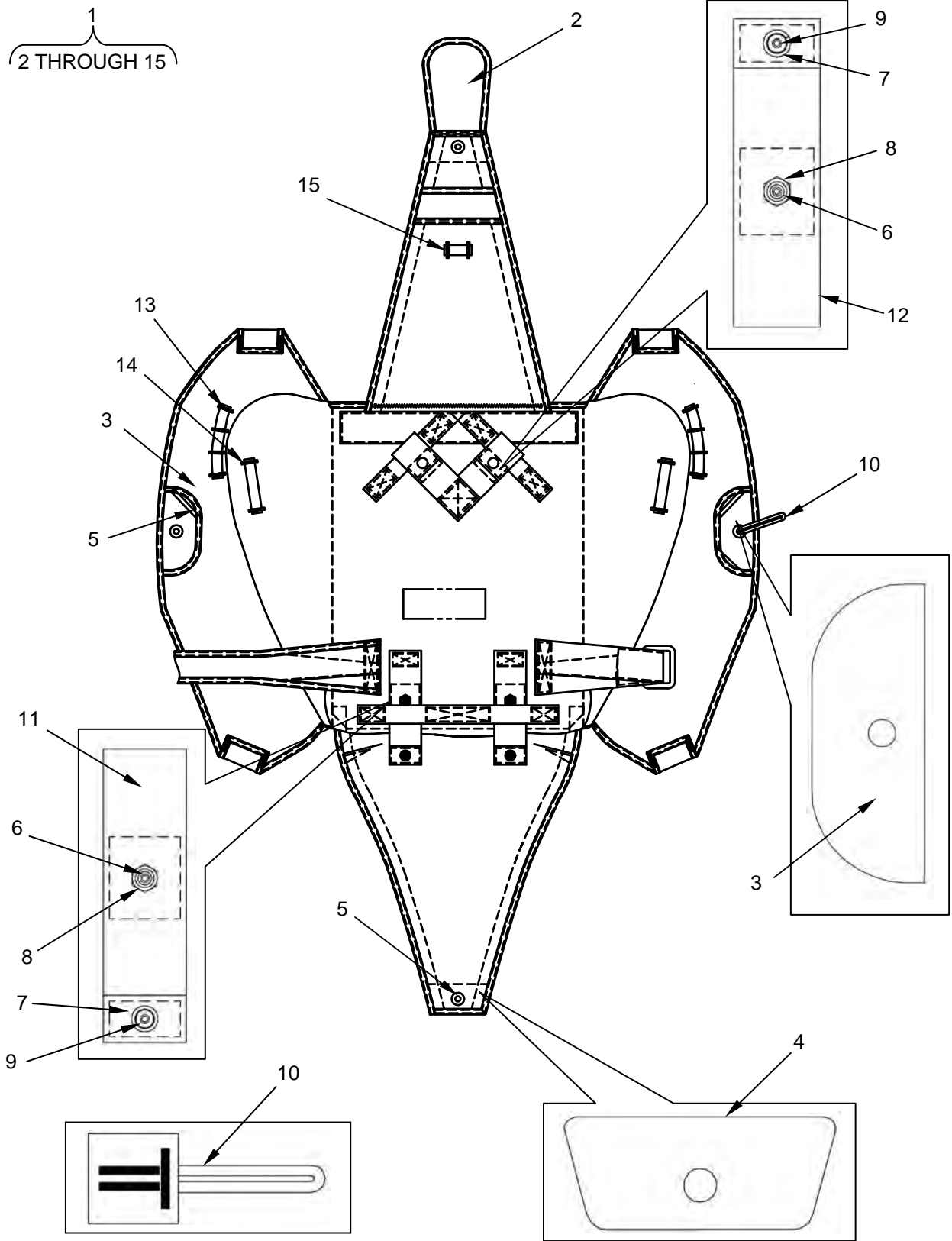

Figure 4. Main Pack Tray.

(1) ITEM NO.	(2) SMR CODE	(3) NSN	(4) CAGEC	(5) PART NUMBER	(6) DESCRIPTION AND USABLE ON CODE (UOC)	(7) QTY
GROUP 03						
FIG. 4 MAIN PACK TRAY						
1	PAOOO	1670-01-567-4709	81337	11-1-7720 -1	PACK TRAY, MAIN, T-11	1
2	PAOZZ	1670-01-535-2232	81337	11-1-7415-1	. PIN COVER, PACK TRAY CLOSING	1
3	PAOZZ	1670-01-535-2237	81337	11-1-7236-1	. STIFFENER, MAIN, SIDE	2
4	PAOZZ	1670-01-535-4256	81337	11-1-7236-3	. STIFFENER, TOP-BOTTOM	2
5	PAOZZ	5325-01-569-5834	81337	11-1-4179-2	. GROMMET, METALLIC ROLLED RIM/SPUR WASHER, 305 STAINLESS STEEL, NO. 0 L	4
6	PAOZZ	5325-00-276-4908	96906	MS27983-3	. STUD, SNAP FASTENER STYLE 4, (FINISH BLACK)	4
7	PAOZZ	5325-00-891-9073	96906	MS27983-1	. CAP, SNAP FASTENER STYLE 4, 24 LINE, SIZE 1, FINISH BLACK, (BUTTON)	4
8	PAOZZ	5325-00-276-4978	96906	MS27983-4	. POST, SNAP FASTENER, STYLE 4, (SIZE 1, FINISH BLACK)	4
9	PAOZZ	5325-00-945-2577	88044	AN227-67B	. SOCKET, SNAP FASTENER, (FINISH BLACK)	4
10	PAOZZ	1670-01-535-2243	81337	11-1-7068-1	. FABRIC LOOP, LARGE	1
11	PAOZZ	1670-01-567-5962	81337	11-1-7124-1	. HORIZONTAL BACK STRAP RETAINER	2
12	PAOZZ	1670-01-567-4710	81337	11-1-7124-2	. DIAGONAL BACK STRAP RETAINER	2
13	MOOZZ		81337	11-1-7130-5	. INNER STATIC LINE STOW BAR. MAKE FROM WEBBING, TEXTILE, NYLON, TYPE I, CLASS 1A, 9/16 INCH WIDE, COLOR FG504, CAGE 81349, P/N MIL-W-4088, (CUT LENGTH 5-1/2 INCHES) AND THREAD, NYLON, TYPE I, II, OR III, CLASS A, SIZE E, COLOR NATURAL, CAGE 81348, P/N V-T-295.	2
14	MOOZZ		81337	11-1-7721-11	. OUTER STATIC LINE STOW BAR. MAKE FROM WEBBING, TEXTILE, NYLON, TYPE I, CLASS 1A, 9/16 INCH WIDE, COLOR FG504, CAGE 81349, P/N MIL-W-4088, (CUT LENGTH 4 INCHES) AND THREAD, NYLON, TYPE I, II, OR III, CLASS A, SIZE E, COLOR NATURAL, CAGE 81348, P/N V-T-295.	2

(1) ITEM NO.	(2) SMR CODE	(3) NSN	(4) CAGEC	(5) PART NUMBER	(6) DESCRIPTION AND USABLE ON CODE (UOC)	(7) QTY
15	MOOZZ		81337	11-1-7129-6	. STATIC LINE SLACK RETAINER. MAKE FROM WEBBING, TEXTILE, NYLON, TYPE I, CLASS 1A, 9/16 INCH WIDE, COLOR FG504, CAGE 81349, P/N MIL-W-4088, (CUT LENGTH 2-3/4 INCHES) AND THREAD, NYLON, TYPE I, II, OR III, CLASS A, SIZE E, COLOR NATURAL, CAGE 81348, P/N V-T-295.	1
END OF FIGURE						

PARTS INFORMATION

T-11 HARNESS ASSEMBLY

1
2 THROUGH 9

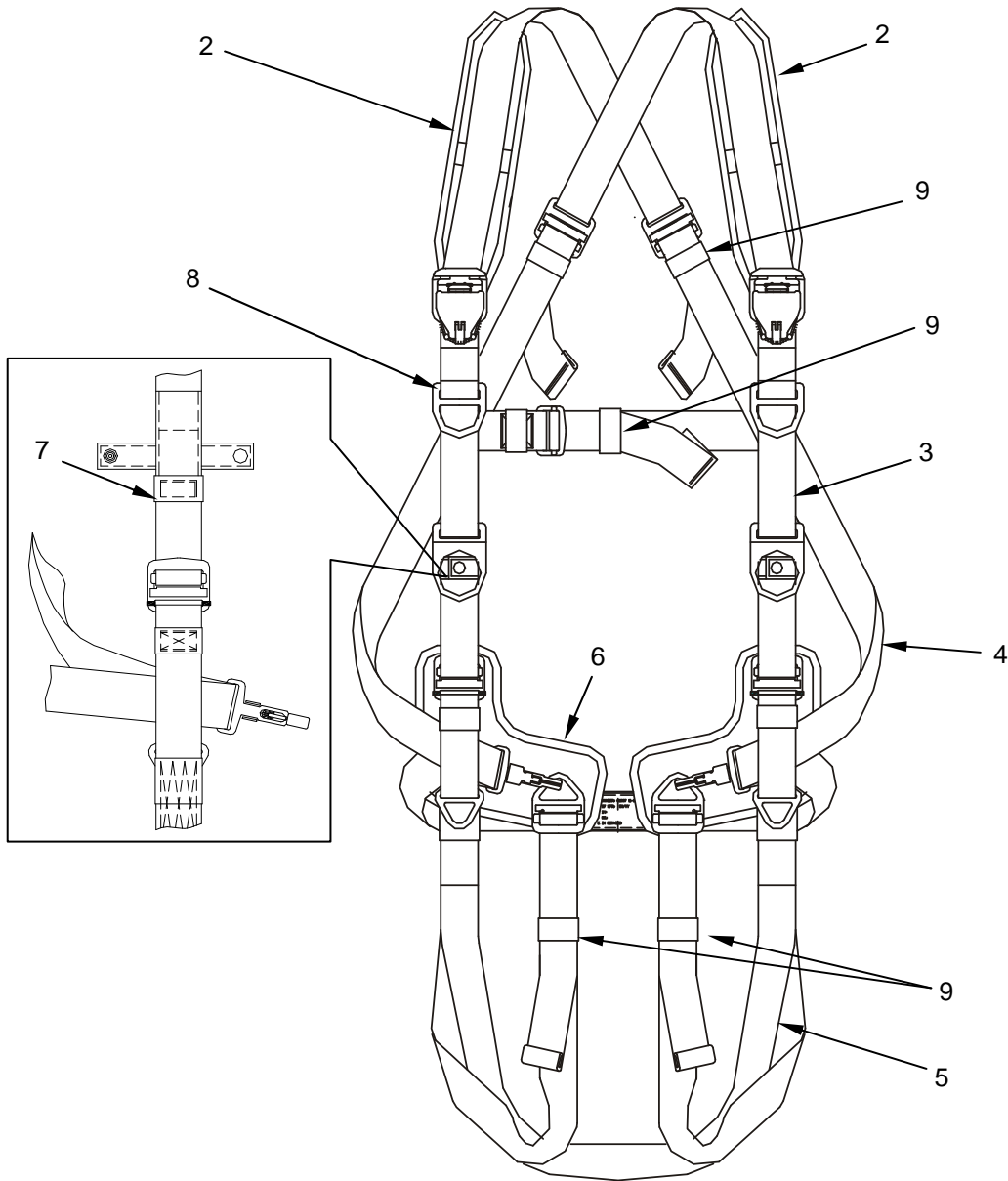

Figure 5. T-11 Harness Assembly.

(1) ITEM NO.	(2) SMR CODE	(3) NSN	(4) CAGEC	(5) PART NUMBER	(6) DESCRIPTION AND USABLE ON CODE (UOC)	(7) QTY
GROUP 04						
FIG. 5 T-11 HARNESS ASSEMBLY						
1	PAOZZ	1670-01-535-2233	81337	11-1-7722-1	HARNESS ASSY, T-11	1
2	PAOZZ	1670-01-535-2242	81337	11-1-7154-1	. SHOULDER PAD ASSY, T-11	2
3	PAOZZ	1670-01-535-2236	81337	11-1-7723-1	. HARNESS, LEFT UPPER	1
4	PAOZZ	1670-01-535-2238	81337	11-1-7157-1	. DIAGONAL ASSY, T-11	1
5	PAOZZ	1670-01-535-2256	81337	11-1-7162-1	. SADDLE ASSY, T-11	1
6	PAOZZ	1670-01-535-2240	81337	11-1-7155-1	. HIP PAD ASSY, T-11	2
7	PAOZZ	1670-01-541-8961	81337	11-1-7164-1	. TUCK TAB ASSEMBLY	2
8	PAOZZ	1670-01-535-2239	81337	11-1-7723-2	. HARNESS, RIGHT UPPER	1
9	MOOZZ		81337	11-1-7153-1	. KEEPER ASSY, EXCESS WEBBING. MAKE FROM: ELASTIC, TYPE 1, CL1, 1 INCH WIDE, FG 504, (CUT SIZE 4 ½ INCHES); THREAD, SIZE E, TYPE I, II OR III, CL4, FG504	6

END OF FIGURE

PARTS INFORMATION

T-11R CANOPY ASSEMBLY

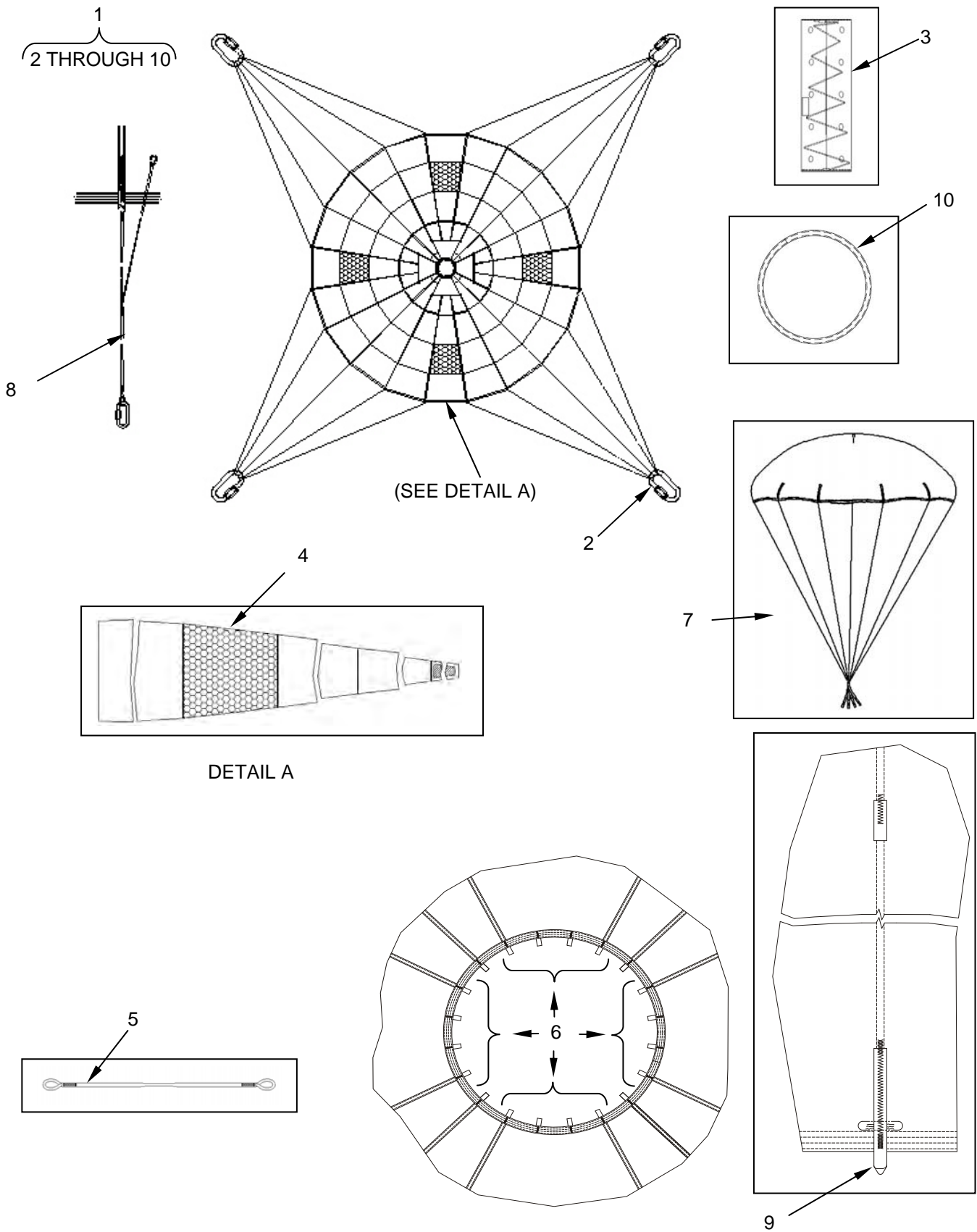

Figure 6. T-11R Canopy Assembly.

(1) ITEM NO.	(2) SMR CODE	(3) NSN	(4) CAGE C	(5) PART NUMBER	(6) DESCRIPTION AND USABLE ON CODE (UOC)	(7) QTY
GROUP 05						
FIG. 6 T-11R CANOPY ASSEMBLY						
1	XAOOO		81337	11-1-7052-1	CANOPY ASSY, T-11R	1
2	PAOZZ	1670-01-330-3691	81337	11-1-7228-3	LINK, PARACHUTE, CONNECTOR (RESERVE SUSPENSION LINE) (SIZE 6)	4
3	PAOZZ	1670-01-535-2246	81337	11-1-7065-1	EJECTOR SPRING ASSY, T11R	1
4	PAOZZ	1670-01-540-3597	81337	11-1-7420-1	VENT PANEL, T-11 RESERVE	4
5	PAOZZ	1670-01-535-2247	81337	11-1-7067-1	CLOSING LOOP ASSEMBLY, T11R	1
6	MOOO O		81337	11-1-7111-7	APEX VENT BRIDLE LOOP. MAKE FROM: WEBBING, NYLON, TYPE I, CLASS 1A, 9/16 IN WIDE, COLOR NATURAL, CAGE 81349, P/N MIL-W-4088 (CUT LENGTH 5.0 IN) AND THREAD, NYLON, TYPE I, II, OR III, CLASS A, SIZE E, COLOR NATURAL, CAGE 81348, P/N V-T-295.	16
7	PAOZZ	1670-01-535-2251	81337	11-1-7064-1	EXTRACTOR ASSY, T11R	1
8	PAOZZ	1670-01-540-3596	81337	11-1-7083-1	SUSPENSION LINE ASSY, T11R	20
9	MOOO O		81337	11-1-7111-4	LOOP, SUSPENSION LINE ATTACHING. MAKE FROM: WEBBING, NYLON, TYPE I, CLASS 1A, 9/16 IN WIDE, COLOR NATURAL, CAGE 81349, P/N MIL-W-4088 (CUT LENGTH 12.0 IN) AND THREAD, NYLON, TYPE I, II, OR III, CLASS A, SIZE E, COLOR NATURAL, CAGE 81348, P/N V-T-295.	20
10	PAOZZ	1670-01-535-4257	81337	11-1-7069-1	CAP ASSY, T-11R, PROTECTION	1

END OF FIGURE

PARTS INFORMATION

T-11 RESERVE RISER SET

1
2 THROUGH 4

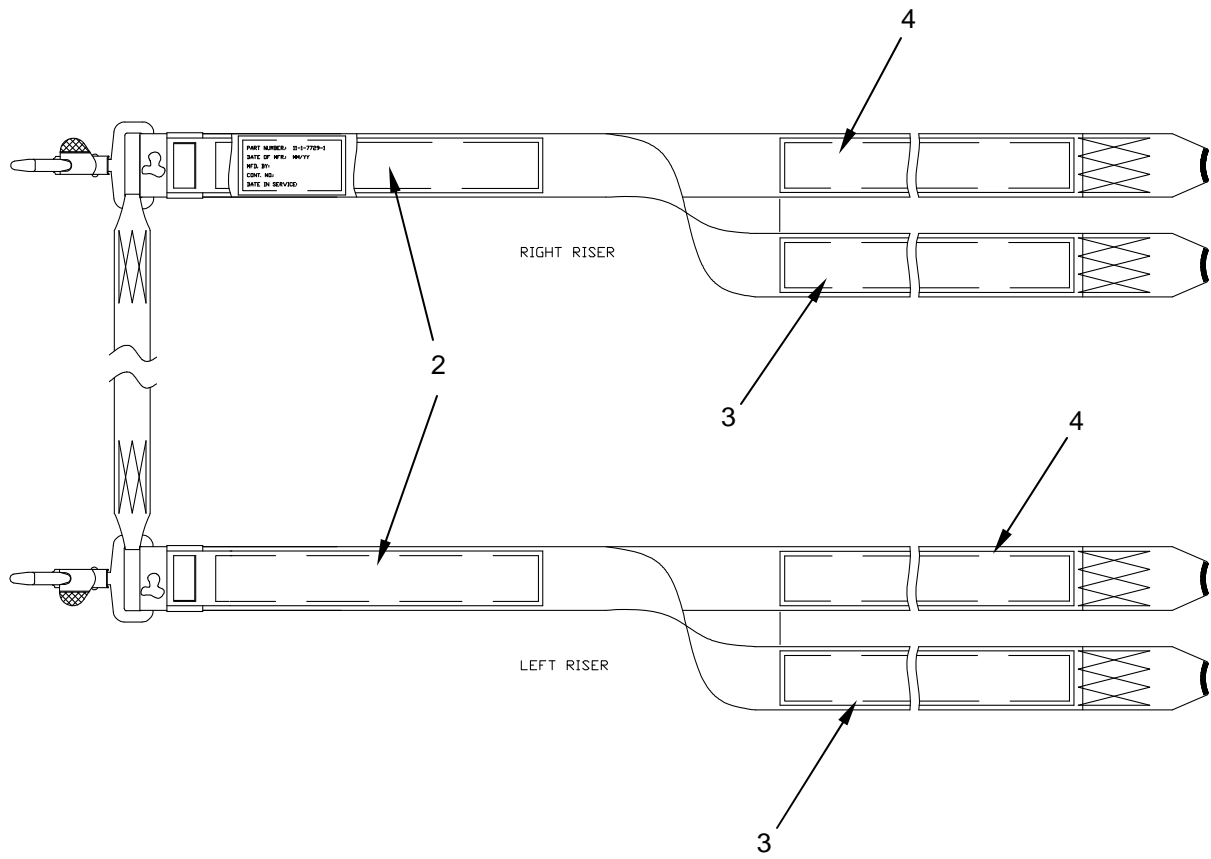

Figure 7. T-11 Reserve Riser Set.

(1) ITEM NO.	(2) SMR CODE	(3) NSN	(4) CAGE C	(5) PART NUMBER	(6) DESCRIPTION AND USABLE ON CODE (UOC)	(7) QTY
GROUP 06						
FIG. 7 T-11 RESERVE RISER SET						
1	PAOZZ	1670-01-535-2255	81337	11-1-7729-1	RISER SET, T-11R	1
2	MOOZZ		81337	11-1-7729-2	. FASTENER, LOOP. MAKE FROM: TAPE, PILE, TYPE II, CLASS 1, 1-1/2 IN WIDE, COLOR FG504, CAGE 58536, P/N A-A-55126 (CUT LENGTH 10-5/8 IN) AND THREAD, NYLON, TYPE I, II, OR III, CLASS A, SIZE E, COLOR NATURAL, CAGE 81348, P/N V-T-295.	1
3	MOOZZ		81337	11-1-7729-8	. FASTENER, LOOP. MAKE FROM: TAPE, PILE, TYPE II, CLASS 1, 1-1/2 IN WIDE, COLOR FG504, CAGE 58536, P/N A-A-55126 (CUT LENGTH 15.0 IN) AND THREAD, NYLON, TYPE I, II, OR III, CLASS A, SIZE E, COLOR NATURAL, CAGE 81348, P/N V-T-295.	1
4	MOOZZ		81337	11-1-7729-7	. FASTENER, HOOK. MAKE FROM: TAPE, HOOK, TYPE II, CLASS 1, 1-1/2 IN WIDE, COLOR FG504, CAGE 58536, P/N A-A-55126-1 (CUT LENGTH 15.0 IN) AND THREAD, NYLON, TYPE I, II, OR III, CLASS A, SIZE E, COLOR NATURAL, CAGE 81348, P/N V-T-295.	1
END OF FIGURE						

PARTS INFORMATION

T-11R PACK TRAY ASSEMBLY

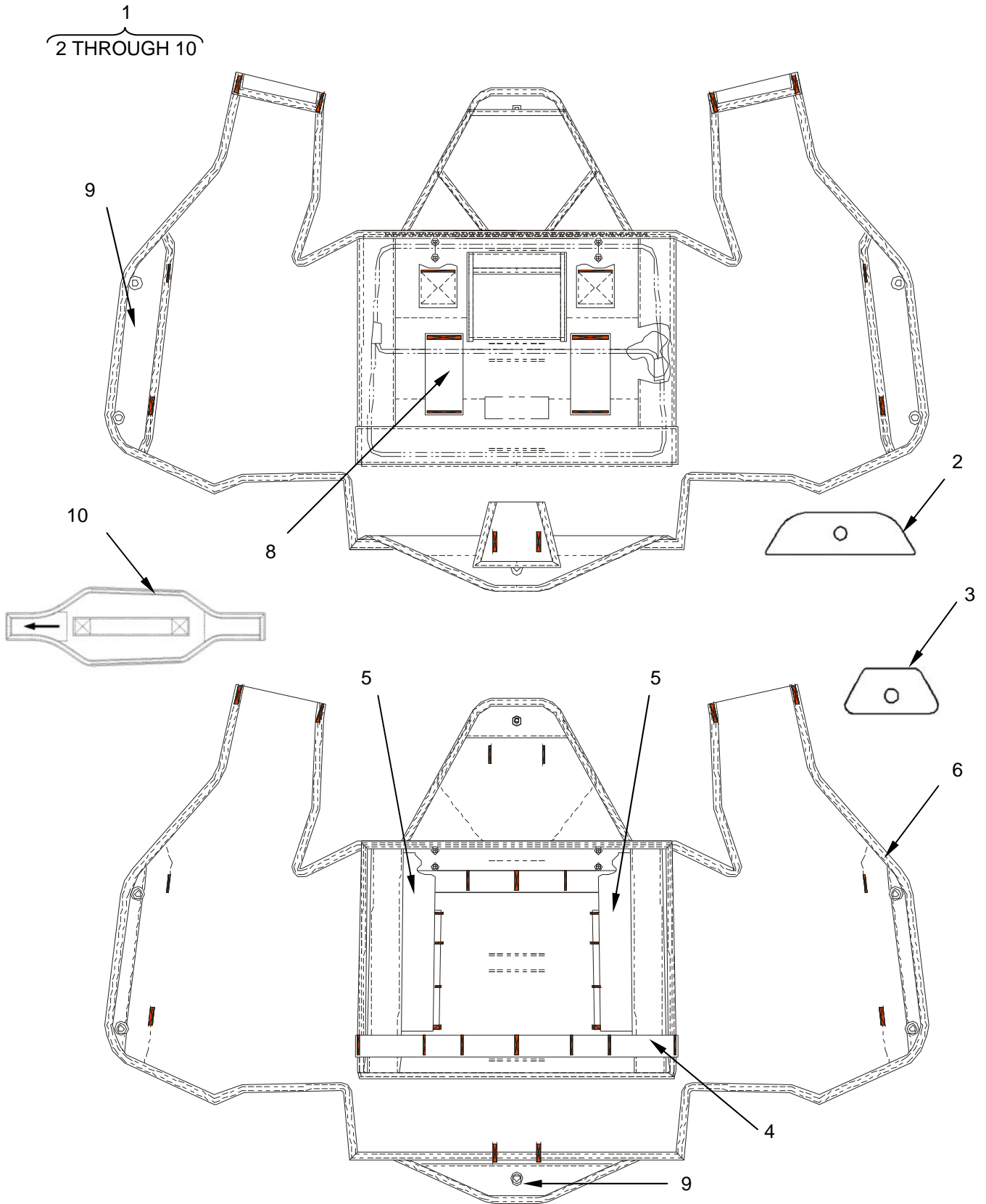

Figure 8. T-11R Pack Tray Assembly.

(1) ITEM NO.	(2) SMR CODE	(3) NSN	(4) CAGEC	(5) PART NUMBER	(6) DESCRIPTION AND USABLE ON CODE (UOC)	(7) QTY
GROUP 07						
FIG. 8 T-11R PACK TRAY ASSEMBLY						
1	PAOOO	1670-01-535-2254	81337	11-1-7726-1	RESERVE PACK TRAY ASSY, T-11R	1
2	PAOZZ	1670-01-535-2249	81337	11-1-7242-1	. STIFFENER, TOP FLAP, T-11 RESERVE	1
3	PAOZZ	1670-01-535-2253	81337	11-1-7242-3	. STIFFENER, BOTTOM FLAP, T-11 RESERVE	1
4	MOOOO		81337	11-1-7743-2	. STOW BAR, ELASTIC, RISER. MAKE FROM: WEBBING, ELASTIC, TYPE I, CLASS I, 1.0 IN WIDE, COLOR FG504, CAGE 81349, P/N PIA-W-5664, (CUT LENGTH 16-1/2 IN) AND THREAD, NYLON, TYPE I, II, OR III, CLASS A, SIZE E, COLOR NATURAL, CAGE 81348, P/N V-T-295.	1
5	MOOOO		81337	11-1-7743-5	. FASTENER, HOOK. MAKE FROM: TAPE, HOOK, TYPE II, CLASS I, 1-1/2 IN WIDE, COLOR FG504, CAGE 58536, P/N A-A-55126-1, (CUT LENGTH 11-1/4 IN) AND THREAD, NYLON, TYPE I, II, OR III, CLASS A, SIZE E, COLOR NATURAL, CAGE 81348, P/N V-T-295.	2
6	MOOOO		81337	11-1-7728-10	. EDGE BINDING. MAKE FROM: TAPE, NYLON, TYPE III, CLASS 2, 3/4 IN WIDE, COLOR FG504, CAGE 81349, P/N MIL-T-5038, (CUT LENGTH AS REQUIRED) AND THREAD, NYLON, TYPE I, II, OR III, CLASS A, SIZE E, COLOR NATURAL, CAGE 81348, P/N V-T-295.	1
7	MOOOO		81337	11-1-7743-3	. STOW BAR, ELASTIC RISER. MAKE FROM: WEBBING, ELASTIC, TYPE I, CLASS I, 1.0 IN WIDE, COLOR FG504, CAGE 81349, P/N PIA-W-5664, (CUT LENGTH 12-1/2 IN) AND THREAD, NYLON, TYPE I, II, OR III, CLASS A, SIZE E, COLOR NATURAL, CAGE 81348, P/N V-T-295.	1
8	MOOOO		81337	11-1-7728-7	. RETAINER, WAISTBAND. MAKE FROM: WEBBING, NYLON, TYPE VIII, CLASS 2, 1-23/32 IN WIDE, COLOR FG504, CAGE 81349, P/N PIA-W-4088, (CUT LENGTH 4-3/4 IN) AND THREAD, NYLON, TYPE I, II, OR III, CLASS A, SIZE E, COLOR NATURAL, CAGE 81348, P/N V-T-295.	2

(1) ITEM NO.	(2) SMR CODE	(3) NSN	(4) CAGEC	(5) PART NUMBER	(6) DESCRIPTION AND USABLE ON CODE (UOC)	(7) QTY
9	PAOZZ	5325-01-569-5834	57771	11-1-4179-2	. GROMMET, METALLIC ROLLED RIM/SPUR WASHER, 305 STAINLESS STEEL, NO. 0 L	6
10	PAOZZ	1670-01-535-2250	81337	11-1-7058-1	. RESERVE RIPCORDER ASSY, T-11R	1

END OF FIGURE

PARTS INFORMATION

T-11 MAIN DEPLOYMENT BAG ASSEMBLY

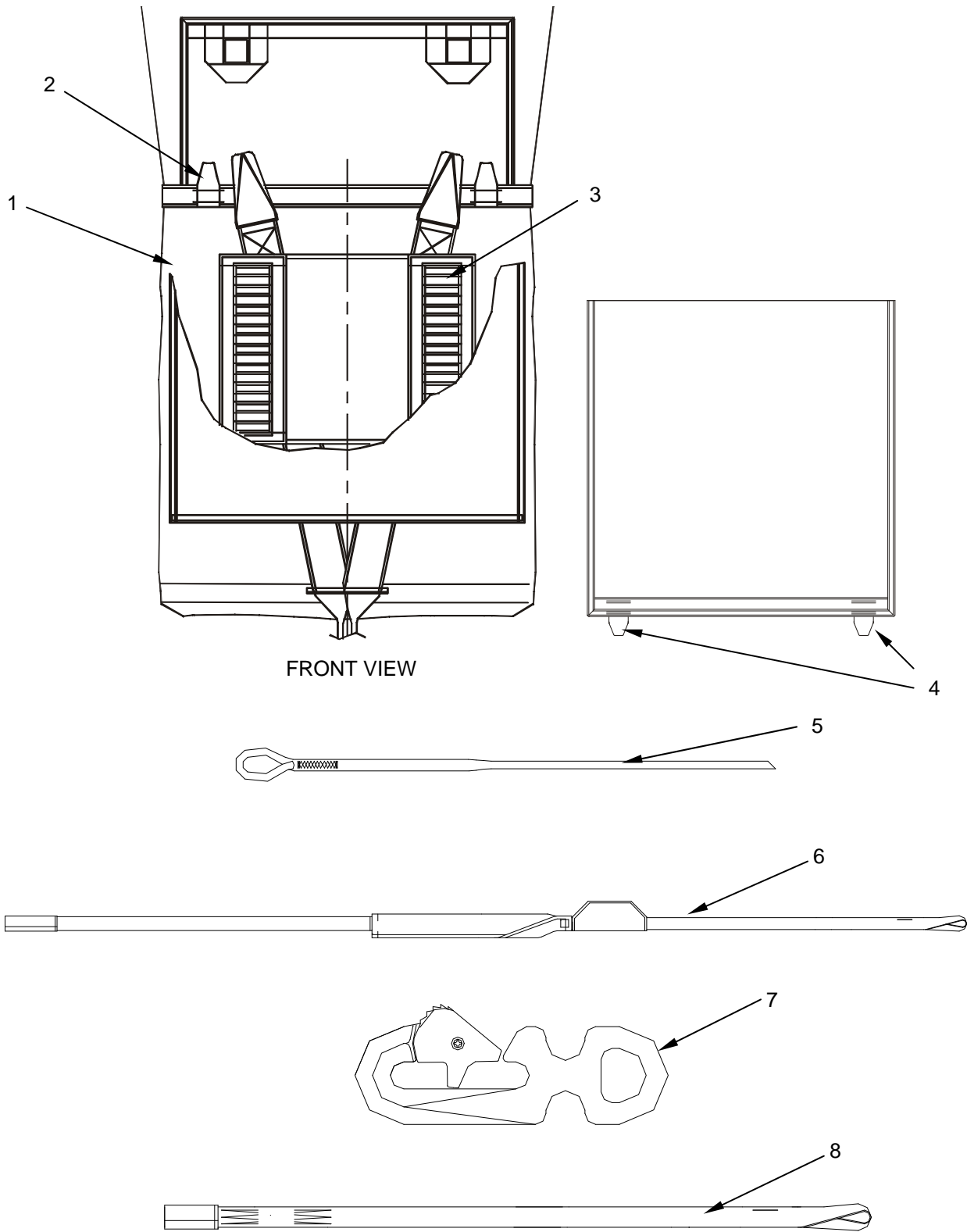

Figure 9. T-11 Main Deployment Bag Assembly.

(1) ITEM NO.	(2) SMR CODE	(3) NSN	(4) CAGEC	(5) PART NUMBER	(6) DESCRIPTION AND USABLE ON CODE (UOC)	(7) QTY
GROUP 08						
FIG. 9 T-11 MAIN DEPLOYMENT BAG ASSEMBLY						
1	PAOOO	1670-01-567-4708	81337	11-1-7063-1	DEPLOYMENT BAG ASSEMBLY, T-11 MAIN	1
2	MOOZZ		81337	11-1-7063-5	.TIE-DOWN LOOP. MAKE FROM: TAPE, NYLON, TYPE IV, CLASS 2, 1.0 IN WIDE, COLOR FG504, CAGE 81349, P/N PIA-T-5038, (CUT SIZE 5.0 IN.) AND THREAD, NYLON, TYPE I, II, OR III, CLASS A, SIZE FF, COLOR FG504, CAGE 81348, P/N V-T-295.	2
3	PAOZZ	1670-01-567-5963	81337	11-1-7140-1	.STOW BAR ASSY, T-11, MAIN BAG	2
4	MOOZZ		81337	11-1-7145-3	TIE-DOWN LOOP. MAKE FROM: TAPE, NYLON, TYPE IV, CLASS 2, 1.0 IN WIDE, COLOR FG504, CAGE 81349, P/N PIA-T-5038, (CUT SIZE 5.0 IN.) AND THREAD, NYLON, TYPE I, II, OR III, CLASS A, SIZE FF, COLOR FG504, CAGE 81348, P/N V-T-295.	2
5	MOOZZ		81337	11-1-7101-1	SUPPORT LOOP, PACKING FRAME MAKE FROM CORD, FIBROUS, POLYESTER, TYPE II, COLOR NATURAL, CAGE 81348, P/N T-C-2754 (CUT LENGTH 14.0 IN.) AND THREAD, NYLON, TYPE I, II, OR III, CLASS A, SIZE E, COLOR NATURAL, CAGE 81348, P/N V-T-295.	4
6	PAOZZ	1670-01-535-2252	81337	11-1-6993-3	STATIC LINE, MODIFIED, PERSONNEL PARACHUTE	1
7	PAOZZ	1670-01-476-3142	81337	11-1-6991-1	STATIC LINE SNAP HOOK	1
8	PAOZZ	1670-01-476-3130	81337	11-1-6993-2	STATIC LINE EXTENSION, PERSONNEL PARACHUTE	1

END OF FIGURE

PARTS INFORMATION

BULK MATERIAL

(1) ITEM NO.	(2) SMR CODE	(3) NSN	(4) CAGEC	(5) PART NUMBER	(6) DESCRIPTION AND USABLE ON CODE (UOC)	(7) QTY
GROUP 99 BULK MATERIAL						
FIG. 99 BULK						
1	PAOZZ		81349	PIA-C-7219	CLOTH, DUCK, NYLON, TYPE III, CLASS 3, COLOR FG504	1
2	PAOZZ		81337	PIA-C-44378	CLOTH, PARACHUTE , NYLON, LOW PERMEABILITY, 1.5 OZ PER SQ YD	1
3	PAOZZ		81349	PIA-C-44378	CLOTH, PARACHUTE, NYLON, LOW PERMEABILITY, RIPSTOP WEAVE, TYPE IV, 1.2 OZ., FG504	1
4	PAOZZ		58536	A-A-55126-1	FASTENER TAPE, HOOK 1-1/2 IN WIDE, TYPE II, CLASS 1, FG504	1
5	PAOZZ		58536	A-A-55126	FASTENER TAPE, PILE 1-1/2 IN WIDE, TYPE II, CLASS 1, FG504	1
6	PAOZZ		81337	11-1-7201-1	TAPE, TEXTILE, PRESHRUNK, NYLON, 1 INCH WIDE, NATURAL	1
7	PAOZZ	8315-00-176-8085	81349	PIA-T-5038	TAPE, TEXTILE, NYLON, TYPE III, CLASS 1A, 1 INCH WIDE, NATURAL	1
8	PAOZZ		81349	PIA-T-5038-3	TAPE, NYLON, TYPE II, CLASS 1A, 1INCH WIDE, FG504	1
9	PAOZZ		81348	V-T-295-4	THREAD NYLON, TYPE I OR II, CLASS A, SIZE 5, FG504	1
10	PAOZZ		81348	V-T-295	THREAD, NYLON, TYPE I OR II, CLASS A, SIZE E, FG504	1
11	PAOZZ	8310-00-244-0611	81348	V-T-295	THREAD, NYLON, TYPE I OR II, CLASS A, SIZE E, WHITE/NATURAL	1
12	PAOZZ	8310-00-262-3324	81348	V-T-295	THREAD, NYLON, TYPE I, CLASS A, SIZE A, WHITE, NATURAL	1
13	PAOZZ		81349	PIA-W-5665	WEBBING, TEXTILE, COTTON, TYPE II, CLASS 2B, 1 INCH WIDE, FG504	1
14	PAOZZ		81349	MIL-W-5664-1	WEBBING, TEXTILE, ELASTIC, TYPE 1, CLASS 1, 1 IN WIDE, FG504	1
15	PAOZZ		81349	PIA-W-4088-3	WEBBING, TEXTILE, WOVEN, NYLON, TYPE III, CLASS 1A, 3/4 INCH WIDE, FG504	1

(1) ITEM NO.	(2) SMR CODE	(3) NSN	(4) CAGEC	(5) PART NUMBER	(6) DESCRIPTION AND USABLE ON CODE (UOC)	(7) QTY
16	PAOZZ		81349	PIA-W-4088-2	WEBBING, TEXTILE, NYLON, TYPE I, CLASS 1A, 9/16 IN WIDE, FG504	1
17	PAOZZ		81349	MIL-W-4088	WEBBING, TEXTILE, TYPE XVII, CLASS 2, FG504, 1.00 IN WIDE	1
18	PAOZZ	8305-00-263-3639	81349	MILW4088-3	WEBBING, TEXTILE, WOVEN, NYLON, TYPE I, CL2, 9/16 WIDE, NATURAL	1
19	PAOZZ		81348	PIA-T-5038	TAPE, NYLON, TYPE III, CLASS 1A, 3/4 INCH WIDE, FG504	1
20	PAOZZ		81349	PIA-W-4088	WEBBING, TEXTILE, NYLON, TYPE VIII, CLASS 2, 1-23/32 INCH WIDE, FG504, CLASS R PER PIA-W-27265	1
21	PAOZZ		81349	PIA-T-5038	TAPE, NYLON, TYPE IV, CLASS 1A, 1.0 INCH WIDE, FG504, CLASS R PER PIA- W-27265	1
22	PAOZZ	8310-01-174-9606	81348	V-T-295	THREAD, NYLON, TYPE I, II, OR III, CLASS A, SIZE 3, COLOR WHITE	1
23	PAOZZ		81348	V-T-295	THREAD, NYLON, TYPE I, II, OR III, CLASS A, SIZE FF, COLOR FG504	1

END OF FIGURE

PARTS INFORMATION

NATIONAL STOCK NUMBER INDEX

STOCK NUMBER	FIG.	ITEM	STOCK NUMBER	FIG.	ITEM
8315- 00-176-8085	99	7	1670- 01-535-2251	6	7
8310- 00-244-0611	99	11	1670- 01-535-2252	1	2
8310- 00-262-3324	99	12	1670- 01-535-2252	9	6
8305- 00-263-3639	99	18	1670- 01-535-2253	8	3
5325- 00-276-4908	4	6	1670- 01-535-2254	1	14
5325- 00-276-4978	4	8	1670- 01-535-2254	8	1
5325- 00-891-9073	4	7	1670- 01-535-2255	1	20
5325- 00-945-2577	4	9	1670- 01-535-2255	7	1
8310- 01-174-9606	99	22	1670- 01-535-2256	5	5
1670- 01-330-3691	2	5	1670- 01-535-4256	4	4
1670- 01-330-3691	6	2	1670- 01-535-4257	1	19
1670- 01-330-4257	6	10	1670- 01-540-3546	6	8
1670- 01-476-3130	1	3	1670- 01-540-3597	6	4
1670- 01-476-3130	9	8	1670- 01-541-8961	5	7
1670- 01-476-3142	1	5	5325- 01-564-5834	8	9
1670- 01-476-3142	9	7	1670- 01-567-2205	2	7
1670- 01-535-2229	3	2	1670- 01-567-2206	2	9
1670- 01-535-2232	4	2	1670- 01-567-2207	2	10
1670- 01-535-2233	1	6	1670- 01-567-2208	1	4
1670- 01-535-2233	5	1	1670- 01-567-2208	2	2
1670- 01-535-2236	5	3	1670- 01-567-2209	2	4
1670- 01-535-2237	4	3	1670- 01-567-2210	1	11
1670- 01-535-2238	5	4	1670- 01-567-2210	2	14
1670- 01-535-2239	5	8	1670- 01-567-2211	1	10
1670- 01-535-2240	5	6	1670- 01-567-2211	2	13
1670- 01-535-2242	5	2	1670- 01-567-4708	1	7
1670- 01-535-2243	4	10	1670- 01-567-4708	9	1
1670- 01-535-2246	1	16	1670- 01-567-4709	1	8
1670- 01-535-2246	6	3	1670- 01-567-4709	4	1
1670- 01-535-2247	1	18	1670- 01-567-4710	4	12
1670- 01-535-2247	6	5	1670- 01-567-5962	4	11
1670- 01-535-2248	1	12	1670- 01-567-5963	9	3
1670- 01-535-2249	8	2	1670- 01-567-7296	1	9
1670- 01-535-2250	1	15	1670- 01-567-7296	3	1
1670- 01-535-2250	8	10	1670- 01-569-2565	2	3
1670- 01-535-2251	1	17	5325- 01-569-5834	4	5

PARTS INFORMATION

PART NUMBER INDEX

PART NUMBER	FIG.	ITEM	PART NUMBER	FIG.	ITEM
11-1-4179-2	4	5	11-1-7111-4	6	9
11-1-4179-2	8	9	11-1-7111-7	6	6
11-1-6991-1	1	5	11-1-7124-1	4	11
11-1-6991-1	9	7	11-1-7124-2	4	12
11-1-6993-2	1	3	11-1-7129-6	4	15
11-1-6993-2	9	8	11-1-7130-5	4	13
11-1-6993-3	1	2	11-1-7140-1	9	3
11-1-6993-3	9	6	11-1-7145-3	9	4
11-1-7050-1	1	1	11-1-7153-1	5	9
11-1-7051-1	2	1	11-1-7154-1	5	2
11-1-7052-1	1	13	11-1-7155-1	5	6
11-1-7052-1	6	1	11-1-7157-1	5	4
11-1-7058-1	1	15	11-1-7162-1	5	5
11-1-7058-1	8	10	11-1-7164-1	5	7
11-1-7059-1	2	7	11-1-7201-1	99	6
11-1-7060-1	1	11	11-1-7228-1	2	3
11-1-7060-1	2	14	11-1-7228-3	2	5
11-1-7061-1	1	10	11-1-7228-3	6	2
11-1-7061-1	2	13	11-1-7236-1	4	3
11-1-7062-1	1	4	11-1-7236-3	4	4
11-1-7062-1	2	2	11-1-7242-1	8	2
11-1-7063-1	1	7	11-1-7242-3	8	3
11-1-7063-1	9	1	11-1-7414-1	3	2
11-1-7063-5	9	2	11-1-7415-1	4	2
11-1-7064-1	1	17	11-1-7420-1	6	4
11-1-7064-1	6	7	11-1-7581-1	2	9
11-1-7065-1	1	16	11-1-7581-2	2	10
11-1-7065-1	6	3	11-1-7719-1	1	9
11-1-7067-1	1	18	11-1-7719-1	3	1
11-1-7067-1	6	5	11-1-7720 -1	4	1
11-1-7068-1	4	10	11-1-7720-1	1	8
11-1-7069-1	1	19	11-1-7721-11	4	14
11-1-7069-1	6	10	11-1-7722-1	1	6
11-1-7081-1	2	4	11-1-7722-1	5	1
11-1-7083-1	6	8	11-1-7723-1	5	3
11-1-7101-1	9	5	11-1-7723-2	5	8
11-1-7106	2	8	11-1-7726-1	1	14
11-1-7106-7	2	6	11-1-7726-1	8	1
11-1-7107	2	11	11-1-7728-10	8	6
11-1-7107-4	2	16	11-1-7728-7	8	8
11-1-7107-5	2	15	11-1-7729-1	1	20
11-1-7107-6	2	12	11-1-7729-1	7	1

PART NUMBER	FIG.	ITEM	PART NUMBER	FIG.	ITEM
11-1-7729-2	7	2	A-A-55126-1	99	4
11-1-7729-7	7	4	AN227-67B	4	9
11-1-7729-8	7	3	MS27983-1	4	7
11-1-7730-1	1	12	MS27983-3	4	6
11-1-7743-2	8	4	MS27983-4	4	8
11-1-7743-3	8	7	PIA-C-44378	99	2
11-1-7743-5	8	5	PIA-C-44378	99	3
A-A-55126	99	5	PIA-C-7219	99	1
			PIA-T-5038	99	7

CHAPTER 5

SUPPORTING INFORMATION
FOR
T-11 PERSONNEL PARACHUTE SYSTEM

SUPPORTING INFORMATION

REFERENCES

SCOPE

This Work Package lists all field manuals, forms, technical manuals and miscellaneous publications referenced throughout this manual.

ARMY REGULATIONS

AR 700-15	Packaging of Materiel
AR 735-11-2	Reporting of Supply Discrepancies
AR 750-1	Army Material Maintenance Policy
AR 750-32	Airdrop, Parachute Recovery, and Aircraft Personnel Escape Systems

DA PAMPHLETS

DA PAM 25-30	Consolidated Index of Army Publications and Blank Forms
DA PAM 738-751	Functional Users Manual for The Army Maintenance Management System-Aviation (TAMMS-A)
DA PAM 750-8	The Army Maintenance Management System (TAMMS) Users Manual

FIELD MANUALS

FM 4-20.102 (FM 10-500-2)	Airdrop of Supplies and Equipment: Rigging Airdrop Platforms
FM 4-25.11 (FM 21-11)	First Aid for Soldiers

FORMS

DA Form 2404	Equipment Inspection & Maintenance Worksheet
DA Form 3912	Army Parachute Log Record
SF 361	Transportation Discrepancy Report
SF 364	Report of Discrepancy (ROD)
SF 368	Product Quality Deficiency Report (PQDR)

TECHNICAL BULLETINS

TB 43-0002-43	Maintenance Expenditure Limits for FSC Group 16 (FSC Class 1670)
TB 750-126	Use of Material Condition Tags and Labels on Army Aeronautical and Air Delivery Equipment

TECHNICAL MANUALS

TM 10-1670-201-23/ T.O. 13C-1-411 NAVAIR 13-1-17	Organizational and DS Maintenance Manual for General Maintenance of Parachutes and Other Airdrop Equipment
TM 10-1670-296-20&P T.O. 13C7-49-2 TM 43-0002-1/ T.O. 13C3-1-10/ NAVAIR 13-1-19	Unit Maintenance Manual (Including Repair Parts and Special Tools List) for Ancillary Equipment for Low Velocity Air Drop System (LVADS) Procedures for the Destruction of Air Delivery Equipment to Prevent Enemy Use
TM 4700-15/1	Equipment Maintenance Forms and Procedures

END OF WORK PACKAGE

SUPPORTING INFORMATION**MAINTENANCE ALLOCATION CHART (MAC)**

INTRODUCTION**The Army Maintenance System MAC**

This introduction provides a general explanation of all maintenance and repair functions authorized at the two maintenance levels under the Two-Level Maintenance System concept.

The MAC (immediately following the introduction) designates overall authority and responsibility for the performance of maintenance functions on the identified end item or component. The application of the maintenance functions to the end item or component shall be consistent with the capacities and capabilities of the designated maintenance levels, which are shown on the MAC in column (4) as:

Field – includes three subcolumns, Crew maintenance (C), Service maintenance (O), and Field maintenance (F).

Sustainment – includes two subcolumns, Below Depot (H) and Depot (D).

The tools and test equipment requirements (immediately following the MAC) list the tools and test equipment (both special tools and common tool sets) required for each maintenance function as referenced from the MAC.

The remarks (immediately following the tools and test equipment requirements) contain supplemental instructions and explanatory notes for a particular maintenance function.

Maintenance Functions

Maintenance functions are limited to and defined as follows:

1. Inspect. To determine the serviceability of an item by comparing its physical, mechanical, and/or electrical characteristics with established standards through examination (e.g., by sight, sound, or feel). This includes scheduled inspection and gagings and evaluation of cannon tubes.
2. Test. To verify serviceability by measuring the mechanical, pneumatic, hydraulic, or electrical characteristics of an item and comparing those characteristics with prescribed standards on a scheduled basis, i.e., load testing of lift devices and hydrostatic testing of pressure hoses.
3. Service. Operations required periodically to keep an item in proper operating condition, e.g., to clean (includes decontaminate, when required), to preserve, to drain, to paint, or to replenish fuel, lubricants, chemical fluids, or gases. This includes scheduled exercising and purging of recoil mechanisms. The following are examples of service functions:
 - a. Unpack. To remove from packing box for service or when required for the performance of maintenance operations.
 - b. Repack. To return item to packing box after service and other maintenance operations.
 - c. Clean. To rid the item of contamination.

INTRODUCTION - CONTINUED

- d. Touch up. To spot paint scratched or blistered surfaces.
 - e. Mark. To restore obliterated identification.
4. Adjust. To maintain or regulate, within prescribed limits, by bringing into proper position, or by setting the operating characteristics to specified parameters.
 5. Align. To adjust specified variable elements of an item to bring about optimum or desired performance
 6. Calibrate. To determine and cause corrections to be made or to be adjusted on instruments of test, measuring, and diagnostic equipment used in precision measurement. Consists of comparisons of two instruments, one of which is a certified standard of known accuracy, to detect and adjust any discrepancy in the accuracy of the instrument being compared.
 7. Remove/Install. To remove and install the same item when required to perform service or other maintenance functions. Install may be the act of emplacing, seating, or fixing into position a spare, repair part, or module (component or assembly) in a manner to allow the proper functioning of an equipment or system.
 8. Paint (Ammunition Only). To prepare and spray color coats of paint so that the ammunition can be identified and protected. The color indicating primary use is applied, preferably, to the entire exterior surface as the background color of the item. Other markings are to be repainted as original so as to retain proper ammunition identification.
 9. Replace. To remove an unserviceable item and install a serviceable counterpart in its place. "Replace" is authorized by the MAC and assigned maintenance level is shown as the third position code of the Source, Maintenance and Recoverability (SMR) code.
 10. Repair. The application of maintenance services, including fault location/troubleshooting, removal/installation, disassembly/assembly procedures and maintenance actions to identify troubles and restore serviceability to an item by correcting specific damage, fault, malfunction, or failure in a part, subassembly, module (component or assembly), end item, or system.

NOTE

The following definitions are applicable to the "repair" maintenance function:

Services. Inspect, test, service, adjust, align, calibrate, and/or replace.

Fault location/troubleshooting. The process of investigating and detecting the cause of equipment malfunctioning; the act of isolating a fault within a system or Unit Under Test (UUT).

Disassembly/assembly. The step-by-step breakdown (taking apart) of a spare/functional group coded item to the level of its least component, that is assigned an SMR code for the level of maintenance under consideration (i.e., identified as maintenance significant).

Actions. Welding, grinding, riveting, straightening, facing, machining, and/or resurfacing.

INTRODUCTION - CONTINUED

11. Overhaul. That maintenance effort (service/action) prescribed to restore an item to a completely serviceable/operational condition as required by maintenance standards in appropriate technical publications. Overhaul is normally the highest degree of maintenance performed by the Army. Overhaul does not normally return an item to like new condition.
12. Rebuild. Consists of those services/actions necessary for the restoration of unserviceable equipment to a like new condition in accordance with original manufacturing standards. Rebuild is the highest degree of material maintenance applied to Army equipment. The rebuild operation includes the act of returning to zero those age measurements (e.g., hours/miles) considered in classifying Army equipment/components.

Explanation of Columns in the MAC

Column (1) Group Number. Column (1) lists Functional Group Code (FGC) numbers, the purpose of which is to identify maintenance significant components, assemblies, subassemblies, and modules with the Next Higher Assembly (NHA).

Column (2) Component/Assembly. Column (2) contains the item names of components, assemblies, subassemblies, and modules for which maintenance is authorized.

Column (3) Maintenance Function. Column (3) lists the functions to be performed on the item listed in column (2). (For a detailed explanation of these functions refer to "Maintenance Functions" outlined above).

Column (4) Maintenance Level. Column (4) specifies each level of maintenance authorized to perform each function listed in column (3), by indicating work time required (expressed as manhours in whole hours or decimals) in the appropriate subcolumn. This work time figure represents the active time required to perform that maintenance function at the indicated level of maintenance. If the number or complexity of the tasks within the listed maintenance function varies at different maintenance levels, appropriate work time figures are to be shown for each level. The work time figure represents the average time required to restore an item (assembly, subassembly, component, module, end item, or system) to a serviceable condition under typical field operating conditions. This time includes preparation time (including any necessary disassembly/assembly time), troubleshooting/fault location time, and quality assurance time in addition to the time required to perform the specific tasks identified for the maintenance functions authorized in the MAC. The symbol designations for the various maintenance levels are as follows:

Field:

- C Operator or Crew maintenance
- O Service maintenance
- F Field maintenance

Sustainment:

- L Specialized Repair Activity
- H Below Depot Maintenance
- D Depot maintenance

INTRODUCTION - CONTINUED**NOTE**

The "L" maintenance level is not included in column (4) of the MAC. Functions to this level of maintenance are identified by work time figure in the "H" column of column (4), and an associated reference code is used in the REMARKS column (6). This code is keyed to the remarks and the SRA complete repair application is explained there.

Column (5) Tools and Equipment Reference Code. Column (5) specifies, by code, those common tool sets (not individual tools), common Test, Measurement and Diagnostic Equipment (TMDE), and special tools, special TMDE, and special support equipment required to perform the designated function. Codes are keyed to the entries in the tools and test equipment table.

Column (6) Remarks Code. When applicable, this column contains a letter code, in alphabetic order, which is keyed to the remarks table entries.

Explanation of Columns in the Tools and Test Equipment Requirements

Column (1) – Tool or Test Equipment Reference Code. The tool or test equipment reference code correlates with a code used in column (5) of the MAC.

Column (2) – Maintenance Level. The lowest level of maintenance authorized to use the tool or test equipment.

Column (3) – Nomenclature. Name or identification of the tool or test equipment.

Column (4) – National Stock Number (NSN). The NSN of the tool or test equipment.

Column (5) – Tool Number. The manufacturer's part number.

Explanation of Columns in Remarks

Column (1) – Remarks Code. The code recorded in column (6) of the MAC.

Column (2) – Remarks. This column lists information pertinent to the maintenance function being performed as indicated in the MAC.

END OF WORK PACKAGE

SUPPORTING INFORMATION

T-11 PERSONNEL PARACHUTE SYSTEM
MAINTENANCE ALLOCATION CHART (MAC)

Table 1. MAC for
T-11 Personnel Parachute System.

(1) GROUP NUMBER	(2) COMPONENT/ ASSEMBLY	(3) MAINTENANCE FUNCTION	(4) MAINTENANCE LEVEL				(5) TOOLS AND EQUIPMENT REF CODE	(6) REMARKS CODE
			FIELD		SUSTAINMENT			
			CREW	MAINTAINER	BELOW DEPOT	DEPOT		
			C	F	H	D		
00	PARACHUTE SYSTEM, PERSONNEL, T-11							
01	ASSEMBLY, PARACHUTE, T-11 MAIN	Service Inspect Repair		1.0 1.0 1.5		6,7 49,57,60, 64,31	A,B C D,E,F	
0101	ASSEMBLY, SUSPENSION LINE	Inspect Replace		0.3 0.5		12,25,72,74	C	
010101	LINK, PARACHUTE, CONNECTOR, (MAIN CANOPY SUSPENSION LINE) (SIZE 6)	Inspect Replace		0.2 0.3		12,72,74	C	
0102	BRIDLE ASSY, T-11 MAIN	Inspect Replace		0.2 0.1		72	C	
010201	LINK, PARACHUTE CONNECTOR (BRIDLE LINE) (SIZE 4)	Inspect Replace		0.1 0.1		72	C	
0103	DROGUE ASSEMBLY, T-11 MAIN	Inspect Replace		0.2 0.1			C	
0104	SLIDER PANEL, T-11 MAIN	Inspect Replace		0.1 1.5		12, 72,74	C E	
010401	GROMMETS, METALLIC (SLIDER PANEL)	Inspect Repair		0.1 0.3		16,29,37,42	C	
0105	PANEL, ARM ASSEMBLY (ARM ASSEMBLIES 1-4)	Inspect Repair Replace		0.1 0.7 1.0		57,60,61, 64,31 57,60,61, 64,31	C E	

Table 1. MAC for
T-11 Personnel Parachute System.

(1) GROUP NUMBER	(2) COMPONENT/ ASSEMBLY	(3) MAINTENANCE FUNCTION	(4) MAINTENANCE LEVEL				(5) TOOLS AND EQUIPMENT REF CODE	(6) REMARKS CODE
			FIELD		SUSTAINMENT			
			CREW	MAINTAINER	BELOW DEPOT	DEPOT		
			C	F	H	D		
0106	ASSEMBLY, CENTER SECTION	Inspect		0.1				C
		Repair		0.3			54,57,60, 61,64,31	E
		Replace		1.0			54,57,60, 61,64,31	
010601	PANELS, REINFORCEMENT, CENTER SECTION ASSEMBLY	Inspect		0.1				C
		Repair		0.5			32,50,54, 58,61	E
010602	PANEL, MESH, T-11, LARGE AND SMALL	Inspect		0.1				C
		Repair		0.7			25,54,57, 60,61,64	E
		Replace		1.0			25,54,57, 60,61,64	
010603	LOOP, PACKING	Inspect		0.1				C
		Repair		0.2			50	
		Replace		0.2			18,50,61, 65,73	
010604	TAB, PACKING	Inspect		0.1				C
		Repair		0.2			49	
		Replace		0.2			18,50,61, 65,73	
0107	ASSEMBLY, DEPLOYMENT SLEEVE	Inspect		0.3				C
		Repair		0.5			50,51,57, 62,64	E
		Replace		0.1				
0108	LOOP, SUSPENSION LINE ATTACHING	Inspect		0.1				C
		Repair		0.3			53,54,59, 61,64,65	
		Replace		0.5			53,54,59, 61,64,65	
0109	SEAMS, MAIN	Inspect		0.1				C
		Repair		0.3			54,57,61, 64,65	
0110	BAND, LOWER LATERAL	Inspect		0.1				C
		Repair		0.3			57,61,64,65	
0111	ASSEMBLY, BRIDLE ATTACHMENT	Inspect		0.1				C
		Repair		0.5			50	
		Replace		0.5			18,50,61, 65,73	

Table 1. MAC for
T-11 Personnel Parachute System.

(1) GROUP NUMBER	(2) COMPONENT/ ASSEMBLY	(3) MAINTENANCE FUNCTION	(4) MAINTENANCE LEVEL				(5) TOOLS AND EQUIPMENT REF CODE	(6) REMARKS CODE
			FIELD		SUSTAINMENT			
			CREW	MAINTAINER	BELOW DEPOT	DEPOT		
			C	F	H	D		
02	RISER SET, T-11 MAIN	Inspect		0.1			1,25,32, 37,59 1,25,32,37	C
		Repair		0.2				
		Replace		0.2				
0201	POCKET, LOG RECORD	Inspect		0.1			59 59,64	C
		Repair		0.3				
		Replace		0.3				
03	PACK TRAY, MAIN T-11	Inspect		0.1			60	C E
		Repair		0.3				
		Replace		0.3				
0301	FABRIC LOOP, LARGE	Inspect		0.1			25,32	C
		Replace		0.3				
0302	PIN COVER, PACK TRAY CLOSING	Inspect		0.1			59,65	C
		Replace		0.3				
0303	GROMMETS, METALLIC (STIFFENER)	Inspect		0.1			16,29,41, 42 29,38,42, 44,59,61, 64	C
		Repair		0.5				
		Replace		0.5				
0304	FASTENER, SNAP (MAIN PACK TRAY)	Inspect		0.1			8,9,13,14, 32 8,9,13,14, 18,20,23, 29,38,61	C
		Repair		0.2				
		Replace		0.2				
0305	STIFFENERS, MAIN, SIDE	Inspect		0.1			29,38,42 59,61,64	C
		Repair		0.3				
		Replace						
0306	STIFFENERS, TOP- BOTTOM	Inspect		0.1			29,38,42 59,61,64	C
		Repair		0.3				
		Replace						
0307	RETAINER, DIAGONAL BACK STRAP	Inspect		0.1			53,59,61,64	C
		Replace		0.3				
0308	RETAINER, HORIZONTAL BACK STRAP	Inspect		0.1			53,59,61,64 53,59,61,64	C
		Repair		0.3				
		Replace		0.3				

Table 1. MAC for
T-11 Personnel Parachute System.

(1) GROUP NUMBER	(2) COMPONENT/ ASSEMBLY	(3) MAINTENANCE FUNCTION	(4) MAINTENANCE LEVEL				(5) TOOLS AND EQUIPMENT REF CODE	(6) REMARKS CODE
			FIELD		SUSTAINMENT			
			CREW	MAINTAINER	BELOW DEPOT	DEPOT		
			C	F	H	D		
04	HARNES ASSEMBLY, T-11	Inspect		0.1			C	
		Replace		0.5				
0401	HIP PAD ASSEMBLY, T-11	Inspect		0.1			C	
		Repair		0.2		57,64		
		Replace		0.2		57,61		
0402	HARNES, LEFT UPPER	Inspect		0.1			C	
		Repair		0.1		55,57,59,		
		Replace		0.5		61,64		
0403	HARNES, RIGHT UPPER	Inspect		0.1			C	
		Repair		0.1		55,57,59,		
		Replace		0.5		61,64		
0404	SADDLE ASSEMBLY, T11	Inspect		0.1			C	
		Replace		0.5		17,46,55,59 61,64		
0405	ASSEMBLY, CANOPY RELEASE	Inspect		0.1			C	
0406	SHOULDER PAD ASSEMBLY, T-11	Inspect		0.1			C	
		Repair		0.2		60,64		
		Replace		0.5		25,50,60,64		
0407	KEEPER ASSY, EXCESS WEBBING	Inspect		0.1			C	
		Replace		0.5		57,61		
0408	DIAGONAL ASSY, T-11 (HORIZONTAL BACK STRAP)	Inspect		0.1			C	
		Repair		0.2		55,61,64		
		Replace		0.2		18,55,61,64		
0409	TUCK TAB ASSEMBLY	Inspect		0.1		12, 25, 73,	E	
		Replace		0.5		74		
05	CANOPY ASSEMBLY, T-11R	Service		2.0			A,B	
		Inspect		1.0			C	
0501	SUSPENSION LINE ASSEMBLY, T-11R	Inspect		0.3			C	
		Replace		0.3		12,25,73, 74		
0502	EXTRACTOR ASSEMBLY, T-11R	Inspect		0.1			C	
		Replace		0.2		61		

Table 1. MAC for
T-11 Personnel Parachute System.

(1) GROUP NUMBER	(2) COMPONENT/ ASSEMBLY	(3) MAINTENANCE FUNCTION	(4) MAINTENANCE LEVEL				(5) TOOLS AND EQUIPMENT REF CODE	(6) REMARKS CODE
			FIELD		SUSTAINMENT			
			CREW	MAINTAINER	BELOW DEPOT	DEPOT		
			C	F	H	D		
0503	EJECTOR SPRING ASSEMBLY, T-11R	Inspect		0.1			34	C
		Test		0.2				H
		Replace		0.1				H
0504	PANELS, GORE	Inspect		0.2			25,30,57, 61,64	C
		Repair		0.5				E,G
0505	VENT PANEL, T-11R	Inspect		0.1			60 54,57,60, 61,64	C
		Repair		0.2				G
		Replace		2.0				
0506	TIES, SKIRT ASSIST	Inspect		0.1			25	C
		Replace		0.3				
0507	LINK, PARACHUTE, CONNECTOR, (RESERVE SUSPENSION LINE)	Inspect		0.1			25,32,73, 74	C
		Replace		0.4				
0508	CAP ASSEMBLY, T-11R, PROTECTION	Inspect		0.1				C
		Replace		0.1				
0509	SCOOP, CANOPY	Inspect		0.2			57,61,64	C
		Repair		0.5				D,E,G
0510	LOOP, BRIDLE, APEX VENT	Inspect		0.1			18,50,61 64,65 18,50,61 64,65	C
		Repair		0.2				I
		Replace		0.3				
0511	LOOP, SUSPENSION LINE ATTACHING	Inspect		0.1				
		Repair		0.2				
06	RISER SET, T-11 RESERVE	Inspect		0.1			1,12,32,57, 72,73,74 1,12,32,57, 72,73,74	C
		Repair		0.3				
		Replace		0.2				
0601	FASTENER, HOOK AND LOOP (RESERVE RISER)	Inspect		0.1			57 18,57,61,65	C
		Repair		0.2				E
		Replace		0.3				
07	PACK TRAY ASSEMBLY, T-11R	Inspect		0.1			25,50,52, 57	C
		Repair		0.2				
		Replace		0.3				

Table 1. MAC for
T-11 Personnel Parachute System.

(1) GROUP NUMBER	(2) COMPONENT/ ASSEMBLY	(3) MAINTENANCE FUNCTION	(4) MAINTENANCE LEVEL				(5) TOOLS AND EQUIPMENT REF CODE	(6) REMARKS CODE
			FIELD		SUSTAINMENT			
			CREW	MAINTAINER	BELOW DEPOT	DEPOT		
			C	F	H	D		
0701	BINDING, EDGE	Inspect		0.1				C
		Repair		0.3			25,57,61, 65	E
0702	GROMMETS, METALLIC (RESERVE PACK TRAY)	Inspect		0.1				C
		Repair		0.3			16,18,29, 38,42,59, 61	E
		Replace		0.3			16,18,29, 38,42,59, 61	E
0703	STOW BARS, ELASTIC RISER	Inspect		0.1				C
		Repair		0.5			50,59,61, 64,65	E
		Replace		0.5			50,59,61, 64,65	E
0704	RETAINER, WAISTBAND	Inspect		0.1				C
		Repair		0.3			50,64	E
		Replace		0.3			18,50,61, 64,65	
0705	FASTENER, HOOK (RESERVE PACK TRAY)	Inspect		0.1				C
		Repair		0.3			59	
		Replace		0.3			18,59,61, 64,65	
0706	STIFFENERS, TOP AND BOTTOM FLAP, T-11R	Inspect		0.1				C
		Replace		0.5			59,61,64	
0707	RESERVE RIPCORD ASSEMBLY, T-11R	Inspect		0.1				C
		Replace		0.3				
		Test		0.3			11	F
08	DEPLOYMENT BAG, MAIN	Inspect		0.1				C
		Repair		0.5			18,50,52, 57,59,61, 64,65	E
0801	STOW BAR ASSY, T-11, MAIN BAG	Inspect		0.1				C
		Repair		0.3			50,59,61, 64,65	
		Replace		0.3			50,59,61, 64,65	
0802	STOW LOOP, LOCKING	Inspect		0.3				C
		Repair		0.1			58	E

Table 1. MAC for
T-11 Personnel Parachute System.

(1) GROUP NUMBER	(2) COMPONENT/ ASSEMBLY	(3) MAINTENANCE FUNCTION	(4) MAINTENANCE LEVEL				(5) TOOLS AND EQUIPMENT REF CODE	(6) REMARKS CODE
			FIELD		SUSTAINMENT			
			CREW	MAINTAINER	BELOW DEPOT	DEPOT		
			C	F	H	D		
0803	LOOP, TIE DOWN	Inspect		0.3			18,57,64, 65	C
		Repair		0.3				
		Replace		0.3				
0804	FLAPS, SIDE	Inspect		0.1			52,57	C
		Repair		0.3				
0807	STATIC LINE, MODIFIED, PERSONNEL	Inspect		0.1				C
		Replace		0.1				
0808	EXTENSION, STATIC LINE, PERSONNEL PARACHUTE	Inspect		0.1				C
		Replace		0.1				
0809	SNAP HOOK, STATIC LINE	Inspect		0.1				C
		Replace		0.1				

Table 2. Tools and Test Equipment for T-11 Personnel Parachute System

(1) Tools or Test Equipment	(2) Maintenance Level	(3) Nomenclature	(4) National Stock Number	(5) Tool Number
1	O	Adapter, Tension Plate	1670-01-532-9101	11-1-7364-1
2	O	Apex Hook	Locally Manufactured	
3	O	Applicator Gun, Glue	5130-01-213-1213	HYSOL 050-LITE
4	O	Ballast, Bag, 14 lb.	Locally Manufactured	
5	O	Ballast, Bag, 27 lb.	Locally Manufactured	
6	O	Brush, Scrub	7920-00-282-2470	7920-00-282-2470
7	O	Brush, Stenciling	7520-00-248-9285	A-A-2903
8	O	Chuck, Socket	5120-00-144-2084	1155-6
9	O	Chuck, Stud	5120-00-144-2088	144-2088
10	O	Cord, Pull Up, Closing (36 inches) (Type III, Nylon, Guttet)	Locally Manufactured	
11	O	Cradle, Deployment Bag Packing	1670-01-548-5066	11-1-7087-1
12	O	Crowfoot Attachment, Socket Wrench, 3/8-inch Drive, Open End, 7/16-inch	5120-01-335-1150	FC014A
13	O	Die Tool, Fastener	5120-00-090-4412	1401
14	O	Die, Eyelet	5120-00-144-2097	1442097
15	O	Electric Pot, Melting	5120-01-249-0380	WP2A-19-1
16	O	File, Hand, Flat	5110-00-249-2848	A-A-2311
17	O	Gun, Glue	Local Purchase	
18	O	Heated Blade Cutter	Local Purchase	
19	O	Holder, Die	5120-00-357-6181	00-357-6181
20	O	Holder, Die Fastener	5120-00-357-6177	192
21	O	Hook, Parachute Packing	1670-00-903-4570	11-1-343
22	O	Inspection Kit, Ripcord Pin Assy	1670-00-910-3866	11-1-595
23	O	Key Set, Socket Head Screw	5120-00-729-6392	GGG-K-275
24	O	Kit Bag, Flyers	8460-00-606-8366	MIL-K-41835
25	O	Knife, Pocket	5110-00-162-2205	A-A-59100
26	O	Line Insertion Tool (Finger Trap Tool)	Local Purchase	
27	O	Line Separator	1670-00-092-8661	11-1-3512

Table 2. Tools and Test Equipment for T-11 Personnel Parachute System

(1) Tools or Test Equipment	(2) Maintenance Level	(3) Nomenclature	(4) National Stock Number	(5) Tool Number
28	O	Machine, Stencil Cutting	7490-00-164-0537	A-A-2722
29	O	Mallet, Rawhide	5120-00-293-3397	RM200
30	O,F	Needle Assortment, Glovers, Sizes 0-4	8315-00-281-9484	FF-N-180
31	O	Needle, Upholsterer's, Curved, Size 3	8315-00-237-4958	A-A-55066
32	O	Needle, Upholsterer's, Curved, Size 5	8315-00-237-4959	A-A-55066
33	O	Packing Loop Tension Device	1670-01-554-2941	11-1-7569-1
34	O	Packing Rod, Reserve Ejector Spring	1670-01-539-1338	11-1-7088-1
35	O	Paddle, Parachute Packing	1670-00-764-6381	11-1-152
36	O	Pin, Temporary Packing	Local Purchase	S7425
37	O	Plate, Tension, Parachute Packing	1670-00-032-2705	11-1-99
38	O	Pliers, Diagonal Cutting	5110-00-222-2708	220-7NS
39	O	Pliers, Lineman's	5120-00-756-1156	B107.20M
40	O	Pliers, Needle Nose	5120-01-021-7473	B107.13M
41	O	Press, Grommet and Eyelet, Hand Operated	5120-00-880-0619	M370
42	O	Punch and Die, Grommet Inserting, No. 00	5120-00-357-5753	216-00
43	O	Punch and Die, Grommet Inserting, Size 0	5120-00-221-1146	217-0
44	O	Punch, Cutting, Double Bow	5110-00-180-0924	149-5/8
45	O	Quick Release, Hook and Lanyard	Locally Manufactured	
46	O	Ruler, Tab, Metal, 16 Inches	7510-00-173-4897	(93287)
47	O,F	Scale, Weighing, 0-10 lb.	6670-00-240-5821	A-A-50062
48	O	Scissors, 8-Inch	Local Purchase	
49	O	Screwdriver, Flat-tip, 1/4-Inch	5120-00-596-8653	B107.15
50	O	Sewing Machine, Bartack, Industrial	Local Purchase	Recommended JUKI L-K-1900 A-HS (8N184)
51	O	Sewing Machine, Box X	Local Purchase	Recommended JUKI L-K-1900 A-HS (8N184)
52	O,F	Sewing Machine, Darning	3530-01-177-8589	207

Table 2. Tools and Test Equipment for T-11 Personnel Parachute System

(1) Tools or Test Equipment	(2) Maintenance Level	(3) Nomenclature	(4) National Stock Number	(5) Tool Number
53	O	Sewing Machine, Double Box X	Local Purchase	Recommended JUKI LR-1900-HS (8N184)
54	O	Sewing Machine, Double Needle	3530-00-892-4636	333RBP-6
55	O,F	Sewing Machine, Heavy Duty	3530-01-177-8588	733R-5
56	O,F	Sewing Machine, Heavy Duty, Zig-Zag	3530-01-181-1421	146RB-2A
57	O,F	Sewing Machine, Light Duty	3530-01-177-8590	7360R
58	O,F	Sewing Machine, Light-Heavy Duty	3530-01-186-3079	SK6F-1
59	O,F	Sewing Machine, Medium Duty	3530-01-177-8591	255RB-3
60	O,F	Sewing Machine, Zig-Zag	Local Purchase	199R-2A (90338)
61	O	Shears, Tailors, 12 Inch	5110-00-223-6370	PD5110-00-223-6370
62	O	Sleeve Organizer, Deployment, T-11 Main	1670-01-554-7404	11-1-7566-1
63	O	Stencil cutting machine, hand operated	7490-00-164-0537	A-A-2722
64	O	Stitch Removal Tool	Local Purchase	
65	O	Tape, Measuring	5210-00-182-4797	W9312
66	O	T-Bar, Packing	1670-01-539-1337	11-1-7089-1
67	O	Test Tube, Spring Compression with 32 Pound Weight	Locally Manufactured (Refer to WP 0084)	
68	O	Tester, Spring, 0 to 80 lbs. (scale)	6635-00-705-5469	A-A-59400
69	O	Weight, Parachute Packing	1670-00-375-9134	AA52197
70	O	Wrench, 5/16-Inch, Box and Open-End	5120-00-228-9503	B107.100
71	O	Wrench, 7/16-Inch, Box and Open-End	5120-00-228-9505	B107.100
72	O	Wrench, Adjustable, 6-Inch	5120-00-264-3795	B107.8
73	O	Wrench, Adjustable, 8-Inch	5120-00-240-5328	B107.8
74	O	Wrench, Torque, 0-300-inch pounds	5120-00-776-1841	B107.14M
75	O	Yardstick, 36 Inches	5120-00-985-6610	(7L527)

Table 3. Remarks for T-11 Personnel Parachute System.

(1) REMARK CODES	(2) REMARKS
A	Service is cleaning of equipment.
B	Service is the packing of parachutes.
C	Inspect is a technical-rigger type inspection.
D	Repair by stitching, darning, or re-stencil canopy panel.
E	Repair by darning, re-tacking, re-stitching, patching, replacement, splicing edge binding tape, and repairing grommets. Replacement of parts authorized for field maintenance.
F	Perform ripcord test.
G	Field repair consists of panel replacement.
H	Perform ejector spring compression test.
I	Repair limited to white non-load bearing apex vent bridle loop.

END OF WORK PACKAGE

FIELD MAINTENANCE

T-11 PERSONNEL PARACHUTE SYSTEM
EXPENDABLE AND DURABLE ITEMS LIST

INTRODUCTION

Scope

This work package lists expendable and durable items that you will need to operate and maintain the T-11 Personnel Parachute System. This list is for information only and is not authority to requisition the listed items. These items are authorized to you by CTA 50-970, Expendable/Durable Items (Except Medical, Class V Repair Parts, and Heraldic Items), CTA 50-909, Field and Garrison Furnishings and Equipment, or CTA 8-100, Army Medical Department Expendable/Durable Items.

Explanations of Columns in Expendable/Durable Items List

Column (1) Item No. This number is assigned to the entry in the list and is referenced in the narrative instructions to identify the item (e.g., Use brake fluid (WP 0098, Item 5)).

Column (2) Level. This column includes the lowest level of maintenance that requires the listed item (include as applicable: C=Operator/Crew, O=Unit/AVUM, F=Direct Support/AVIM, H=General Support, D=Depot).

Column (3) National Stock Number (NSN). This is the NSN assigned to the item which you can use to requisition it.

Column (4) Item Name, Description, Part Number/(CAGEC). This column provides the other information you need to identify the item. The last line below the description is the part number and the Commercial and Government Entity Code (CAGEC) (in parentheses).

Column (5) U/I. Unit of Issue (U/I) code shows the physical measurement or count of an item, such as gallon, dozen, gross, etc.

Table 1. Expendable and Durable Items List.

(1) Item No.	(2) Level	(3) National Stock Number (NSN)	(4) Item Name, Description, Part Number/(CAGEC)	(5) U/I
1	O, F	7510-01-459-5471	Band, Rubber, Parachute, 7/8 inch long x 1/16 inch wide	LB
2	O, F	1670-01-539-1339	Band, Rubber Parachute, 1-1/4-inch long x 3/8-inch wide	BX
3	O, F	1670-01-323-9900	Band, Rubber Parachute, 2-inches long, 3/8-inch wide	BX
4	O, F	9160-00-253-1171	Beeswax	LB
5	O, F		Army Parachute, Log Record (DA FORM 3912)	BX
6	O, F	7520-00-248-9285	Brush, Stenciling	EA
7	O, F	5325-00-359-6844	Cap, Snap Fastener, Style 2, 24 Line, (Size 1, Finish Black)	HD

Table 1. Expendable and Durable Items List.

(1) Item No.	(2) Level	(3) National Stock Number (NSN)	(4) Item Name, Description, Part Number/(CAGEC)	(5) U/I
8	O, F	5325-00-891-9073	Cap, Snap Fastener, Style 4, 24 Line, (Size 1, Finish Black)	EA
9	O, F	7930-01-506-9885	Cleaner, Industrial, Multipurpose Cleaning Fluid, (1010) (Everblum, Gold™)	GL
10	O, F	5350-00-221-0872	Cloth, Abrasive	YD
11	O, F		Cloth, Duck, Nylon, Type III, Class 3, FG504, PIA-C-7219A	YD
12	O, F		Cloth, Parachute, Nylon, Low Permeability, Ripstop, MIL-C-44378, Type IV, 1.2 oz., FG504	YD
13	O, F		Cloth, Parachute, Nylon, Low Permeability, 1.5 oz. Per Square Yard	YD
14	O, F	1670-01-359-9485	Cord, Fibrous, 600-Pound, T-C-2754, Type I, Natural (Polyester)	RL
15	O, F	4020-00-262-2147	Cord, Fibrous, Nylon, MIL-C-5040H, Red, Type III	SL
16	O, F		Cord, Fibrous, Nylon, Type II, FG504	RL
17	O, F		Cord, Fibrous, Nylon, Type III, MIL-C-5040, FG504	YD
18	O, F		Cord, Spectra®, #1000 (700 lb Tensile Strength)	YD
19	O, F	7930-00-281-4731	Dishwashing Compound	SA
20	O, F	5325-01-023-3843	Eyelet, Metallic, Style 2, (Size 1, Finish Black)	HD
21	O, F	5325-00-276-4978	Eyelet, Metallic, Style 4, (Size 1, Finish Black)	HD
22	O, F		Fastener Tape, Hook, 1-1/2-inch wide, A-A-55126, Type II, Class 1, FG504	RL
23	O, F		Fastener Tape, Pile, 1-1/2-inch wide, A-A-55126, Type II, Class 1, FG504	RL
24	O, F	Local Purchase	Glue Stick, Hot Melt (For Glue Applicator Gun)	PG
25	O, F	5325-01-569-5834	Grommet, Rolled Rim/Spur Washer, 305 Stainless Steel, No. 0L	EA
26	O, F	7510-00-268-5362	Ink, Parachute Marking, Light Blue, A-A-59291	BT
27	O, F	9150-01-260-2534	Lubricant, Solid Film (16 oz. can)	CN
28	O, F	7520-00-973-1059	Marker, Felt Tip, Black, Permanent	BX

Table 1. Expendable and Durable Items List.

(1) Item No.	(2) Level	(3) National Stock Number (NSN)	(4) Item Name, Description, Part Number/(CAGEC)	(5) U/I
29	O, F	7520-01-060-5820	Pen, Ball Point	BX
30	O, F	7510-00-264-4612	Pencil, China Marker, Yellow, A-A-87	DZ
31	O, F	7510-00-240-1525	Pencil, Marking, China, White, A-A-87	DZ
32	O, F		Pin, Steel, T, Size 24	BX
33	O, F	7920-00-205-3570	Rag, Wiping	BE
34	O, F		Ring, No.3, (PN: 11-1-3540, CAGE 81337)	EA
35	O, F	5325-00-285-6250	Socket, Snap Fastener, Style 2, (Finish Black)	HD
36	O, F	5325-00-945-2577	Socket, Snap Fastener, Style 4, (Finish Black)	EA
37	O, F	9310-00-160-7858	Stencil Board, Oiled	SH
38	O, F	5325-00-842-1879	Stud, Snap Fastener, Style 2, (Finish Black)	HD
39	O, F	5325-00-276-4908	Stud, Snap Fastener, Style 4, (Finish Black)	HD
40	O, F		Tape, Kevlar, 1-inch wide, Type IV, Natural	YD
41	O, F	4020-00-753-6555	Tape, Lacing and Tying, Nylon, A-A-52080-B-3	YD
42	O, F		Tape, Nylon, MIL-T-5038, Type III, Class 1, 1/2-inch wide, FG504, PIA-T-5038 (81348)	YD
43	O, F		Tape, Nylon, MIL-T-5038, Type III, Class 1, 3/4-inch wide, FG504	YD
44	O, F		Tape, Textile, Nylon, Type II, Class 1A, 1 inch wide, FG504	YD
45	O, F	8315-00-176-8085	Tape, Textile, Nylon, Type III, Class 1A, 1 inch wide, Natural	YD
46	O, F		Tape, Nylon, Type IV, Class 1A, 1 inch Wide, FG504, PIA-T-5638 (81348)	YD
47	O, F		Tape, Preshrunk, Nylon, 1-inch Wide, Natural, 11-17201-1 (81337)	YD
48	O, F	8310-01-279-6073	Thread, Cotton, Ticket 8/4, Orange, A-A-52094	TU

Table 1. Expendable and Durable Items List.

(1) Item No.	(2) Level	(3) National Stock Number (NSN)	(4) Item Name, Description, Part Number/(CAGEC)	(5) U/I
49	O, F	8310-00-261-9741	Thread, Cotton, White, 24/4	TU
50	O, F	8310-00-244-0611	Thread, Nylon, Type I or II, Class A, Size E, Natural	TU
51	O, F	8310-01-174-9606	Thread, Nylon, Type I, II or III, Class A, Size 3, Color White	TU
52	O, F		Thread, Nylon, V-T-295, Type I or II, Class A, Size 5, FG504	TU
53	O, F		8310-00-262-3324	Thread, Nylon, V-T-295, Type I, Class A, Size A, White/Natural
54	O, F		Thread, Nylon, V-T-295, Type I or II, Class A, Size E, FG504	TU
55	O, F	9160-00-285-2044	Wax, Paraffin	LB
56	O, F		Webbing, Cotton, Type II, Class 2B, 1-inch Wide, FG504, PIA-W5665 (81349)	YD
57	O, F		Webbing, Elastic, Type I, Class I, 1-inch wide, FG504	YD
58	O, F		Webbing, Nylon, Bally #8962, 3/8-inch wide	YD
59	O, F		Webbing, Nylon, MIL-W-4088, Type II, 1-inch Wide, FG504	YD
60	O, F		Webbing, Nylon, MIL-W-4088, Type XII, 1-1/32-inch Wide, FG504	YD
61	O, F		Webbing, Nylon, MIL-W-4088, Type XII, 1-inch Wide, FG504	YD
62	O, F		Webbing, Nylon, Type I, 1 1/4-inch wide, Natural	YD
63	O, F	8305-00-263-3639	Webbing, Nylon, Type I, Class 2, 9/16-inch wide, Natural	YD
64	O, F		Webbing, Nylon, Type III, Class 1A, 3/4 -inch wide, FG504	YD
65	O, F		Webbing, Nylon, Type I, 9/16-inch wide, FG504	YD
66	O, F		Webbing, Nylon, Type VIII, 1-23/32-inch Wide, FG504	YD

Table 1. Expendable and Durable Items List.

(1) Item No.	(2) Level	(3) National Stock Number (NSN)	(4) Item Name, Description, Part Number/(CAGEC)	(5) U/I
67	O, F		Webbing, Nylon, Type XVII, Class 2, 1-inch Wide, FG504	YD
68	O, F	8305-00-268-2411	Webbing, Textile, Cotton, Type I, 1/4-inch Wide, Natural	YD
69	O, F		Thread, Nylon, V-T-295, Type I, II or III, Class A, Size FF, Color FG504	TU

END OF WORK PACKAGE

FIELD MAINTENANCE

**T-11 PERSONNEL PARACHUTE SYSTEM
TOOL IDENTIFICATION LIST**

INTRODUCTION

Scope

This work package lists all common tools and supplements and special tools/fixtures needed to maintain the T-11 Personnel Parachute System.

Explanation of Columns in the Tool Identification List

Column (1) Item No. This number is assigned to the entry in the list and is referenced in the initial setup to identify the item (e.g., “Extractor (WP 0091, Item 17)”).

Column (2) Item Name. This column lists the item by noun nomenclature and other descriptive features (e.g., “Gage, belt tension”).

Column (3) National Stock Number (NSN). This is the National Stock Number (NSN) assigned to the item; use it to requisition the item.

Column (4) Part Number/(CAGEC). Indicates the primary number used by the manufacturer (individual, company, firm, corporation, or Government activity) which controls the design and characteristics of the item by means of its engineering drawings, specifications, standards, and inspection requirements to identify an item or range of items. The manufacturer’s Commercial and Government Entity Code (CAGEC) is also included.

Column (5) Reference. This column identifies the authorizing supply catalog or RPSTL for items listed in this work package.

Table 1. Tool Identification List for T-11 Personnel Parachute System.

(1) Item Number	(2) Item Name	(3) National Stock Number	(4) Part Number (CAGEC)	(5) Reference
1	Adapter, Tension Plate	1670-01-532-9101	11-1-7364-1	
2	Apex Hook	Locally manufactured		
3	Applicator, Glue Gun	5130-01-213-1213	HYSOL050-LITE	
4	Ballast, Bag, 14 lb.	Locally Manufactured		
5	Ballast, Bag, 27 lb.	Locally Manufactured		
6	Brush, Scrub	7920-00-282-2470	7920-00-282-2470	
7	Brush, Stenciling	7520-00-248-9285	A-A-2903	
8	Chuck, Socket	5120-00-144-2084	1155-6	

Table 1. Tool Identification List for T-11 Personnel Parachute System.

(1) Item Number	(2) Item Name	(3) National Stock Number	(4) Part Number (CAGEC)	(5) Reference
9	Chuck, Stud	5120-00-144-2088	144-2088	
10	Cord, Pull Up, Closing (36 inches) (Type III, Nylon, Guttled)	Locally Manufactured		
11	Cradle, Deployment Bag Packing	1670-01-548-5066	11-1-7087-1	
12	Crowfoot Attachment, Socket Wrench, 3/8-inch Drive, Open End, 7/16-inch	5120-01-335-1150	FC014A	
13	Die Tool, Fastener	5120-00-090-4412	1401	
14	Die, Eyelet	5120-00-144-2097	1442097	
15	Electric Pot, Melting	5120-01-249-0380	WP2A-19-1	
16	File, Hand, Flat	5110-00-249-2848	A-A-2311	
17	Gun, Glue	Local Purchase		
18	Heated Blade Cutter	Local Purchase		
19	Holder, Die	5120-00-357-6181	00-357-6181	
20	Holder, Die Fastener	5120-00-357-6177	192	
21	Hook, Parachute Packing	1670-00-903-4570	11-1-343	
22	Inspection Kit, Ripcord Pin Assy	1670-00-910-3866	11-1-595	
23	Key Set, Socket Head Screw	5120-00-729-6392	GGG-K-275	
24	Kit Bag, Flyer's	8460-00-606-8366	MIL-K-41835	
25	Knife, Pocket	5110-00-162-2205	A-A-59100	
26	Line Insertion Tool (Finger Trap Tool)	Local Purchase		
27	Line Separator	1670-00-092-8661	11-1-3512	
28	Machine, Stencil Cutting	7490-00-164-0537	A-A-2722	
29	Mallet, Rawhide	5120-00-293-3397	RM200	
30	Needle Assortment, Glovers, Sizes 0-4	8315-00-281-9484	FF-N-180	
31	Needle, Upholsterer's, Curved, Size 3	8315-00-237-4958	A-A-55066	

Table 1. Tool Identification List for T-11 Personnel Parachute System.

(1) Item Number	(2) Item Name	(3) National Stock Number	(4) Part Number (CAGEC)	(5) Reference
32	Needle, Upholsterer's, Curved, Size 5	8315-00-237-4959	A-A-55066	
33	Packing Loop Tension Device	1670-01-554-2941	11-1-7569-1	
34	Packing Rod, Reserve Ejector Spring	1670-01-539-1338	11-1-7088-1	
35	Paddle, Parachute Packing	1670-00-764-6381	11-1-152	
36	Pin, Temporary Packing	Local Purchase	S7425	
37	Plate, Tension, Parachute Packing	1670-00-032-2705	11-1-99	
38	Pliers, Diagonal Cutting	5110-00-222-2708	220-7NS	
39	Pliers, Lineman's	5120-00-756-1156	B107.20M	
40	Pliers, Needle Nose	5120-01-021-7473	B107.13M	
41	Press, Grommet and Eyelet, Hand Operated	5120-00-880-0619	M370	
42	Punch and Die, Grommet Inserting, No 00	5210-00-357-5753	216-00	
43	Punch and Die, Grommet Inserting, Size 0	5120-00-221-1146	217-0	
44	Punch, Cutting, Double Bow	5110-00-180-0924	149-5/8	
45	Quick Release, Hook and Lanyard	Locally Manufactured		
46	Ruler, Tab, Metal, 16 Inches	7510-00-173-4897	(93287)	
47	Scale, Weighing, 0-10 lb.	6670-00-240-5821	A-A-50062	
48	Scissors, 8-Inch	Local Purchase		
49	Screwdriver, Flat-tip, 1/4-Inch	5120-00-596-8653	B107.15	
50	Sewing Machine, Bartack, Industrial	Local purchase	Recommended JUKI L-K-1900 A-HS (8N184)	
51	Sewing Machine, Box X	Local Purchase	Recommended JUKI LK-1900A-HS (8N184)	
52	Sewing Machine, Darning	3530-01-177-8589	207	

Table 1. Tool Identification List for T-11 Personnel Parachute System.

(1) Item Number	(2) Item Name	(3) National Stock Number	(4) Part Number (CAGEC)	(5) Reference
53	Sewing Machine, Double Box X	Local Purchase	Recommended JUKI LR-1900-HS (8N184)	
54	Sewing Machine, Double Needle	3530-00-892-4636	333RBP-6	
55	Sewing Machine, Heavy Duty	3530-01-177-8588	733R-5	
56	Sewing Machine, Heavy Duty, Zig-Zag	3530-01-181-1421	146RB-2A	
57	Sewing Machine, Light Duty	3530-01-177-8590	7360R	
58	Sewing Machine, Light-Heavy Duty	3530-01-186-3079	SK6F-1	
59	Sewing Machine, Medium Duty	3530-01-177-8591	255RB-3	
60	Sewing Machine, Zig-Zag	Local Purchase	199R-2A (90338)	
61	Shears, Tailors, 12 Inch	5110-00-223-6370	PD5110-00-223- 6370	
62	Sleeve Organizer, Deployment, T-11 Main	1670-01-554-7404	11-1-7566-1	
63	Stencil Cutting Machine, Hand Operated	7490-00-164-0537	A-A-2722	
64	Stitch Removal Tool	Local Purchase		
65	Tape, Measuring	5210-00-182-4797	W9312	
66	T-Bar, Packing	1670-01-539-1337	11-1-7089-1	
67	Test Tube, Spring Compression with 32 Pound Weight	Locally Manufactured (Refer to WP 0089)		
68	Tester, Spring, 0 to 80 lbs. (scale)	6635-00-705-5469	A-A-59400	
69	Weight, Parachute Packing	1670-00-375-9134	AA52197	
70	Wrench, 5/16-Inch, Box and Open-End	5120-00-228-9503	B107.100	
71	Wrench, 7/16-Inch, Box and Open-End	5120-00-228-9505	B107.100	
72	Wrench, Adjustable, 6-Inch	5120-00-264-3795	B107.8	
73	Wrench, Adjustable, 8-Inch	5120-00-240-5328	B107.8	

Table 1. Tool Identification List for T-11 Personnel Parachute System.

(1) Item Number	(2) Item Name	(3) National Stock Number	(4) Part Number (CAGEC)	(5) Reference
74	Wrench, Torque, 0-300-inch pounds	5120-00-776-1841	B107.14M	
75	Yardstick, 36 Inches	5120-00-985-6610	(7L527)	

END OF WORK PACKAGE

SUPPORTING INFORMATION

ALPHABETICAL INDEX

A

Assembling the Main Canopy WP 0008
 Assembling the Reserve Canopy WP 0009

B

Bulk Material List..... WP 0095

C

Capabilities, Features, and Equipment Characteristics WP 0002
 Care, Handling, and Safety WP 0001
 Checks and Services (PMCS):
 Cleaning and Drying..... WP 0010
 Corrosion Prevention and Control (CPC)..... WP 0001

D

Data, Equipment WP 0002
 Description:
 and Location of Major Components WP 0002
 Destruction of Army Materiel to Prevent Enemy Use WP 0001

E

Equipment:
 Characteristics, Capabilities, and Features WP 0002
 Description and Data..... WP 0002
 Improvement Recommendations (EIR), Reporting WP 0001
 Expendable/Durable Items List WP 0101

F

Features, Equipment Characteristics, and Capabilities WP 0002
 Field Preventive Maintenance Checks and Services (PMCS)..... WP 0005

G

General Information WP 0001
 General Repair Procedures for Main and Reserve Parachutes, Field Maintenance..... WP 0016

H

Harness Assembly:
 Harness Assembly-Replace WP 0047
 Hip Pad Assembly-Repair, Replace WP 0048
 Saddle Assembly / Right and Left Harness -Repair, Replace WP 0049
 Shoulder Pad-Repair, Replace WP 0050

I

Illustrated List of Manufactured Items WP 0084
 Improvement Recommendations (EIR), Reporting Equipment..... WP 0001

L

Location and Description of Major Components WP 0002

M

Main Canopy:

- Arm Sections, Repair, Replace..... WP 0028
- Bridle Attachment Assembly, Repair, Replace..... WP 0035
- Bridle Line, Replace..... WP 0022
- Bridle Line Connector Links, Replace..... WP 0023
- Center Section, Repair, Replace..... WP 0028
- Cross Seam, Repair..... WP 0016
- Deployment Sleeve, Repair, Replace..... WP 0031
- Drogue Parachute, Replace..... WP 0024
- Log Record Book Pocket, Repair, Replace..... WP 0037
- Lower Lateral Band, Repair..... WP 0034
- Mesh Panel Assembly, Repair, Replace..... WP 0030
- Main Seam, Repair..... WP 0033
- Skirt Band, Repair..... WP 0016
- Slider, Replace..... WP 0025
- Slider Grommets, Repair..... WP 0026
- Suspension Line, Replace..... WP 0020
- Suspension Line Attaching Loop, Repair, Replace..... WP 0032
- Suspension Line Connector Link, Replace..... WP 0021

Main Deployment Bag:

- Locking Stow Loop, Repair..... WP 0075
- Main Deployment Bag, Repair..... WP 0073
- Side Flaps, Repair..... WP 0077
- Suspension Line Stow Loops, Repair, Replace..... WP 0074
- Tie Down Loop, Repair, Replace..... WP 0076

Main Pack Tray:

- Closing Pin Cover, Replace..... WP 0040
- Large Fabric Loop, Replace..... WP 0039
- Main Pack Tray-Repair, Replace..... WP 0038
- Snap Fastener, Repair, Replace..... WP 0042
- Stiffener Grommets, Repair, Replace..... WP 0041
- Stiffeners, Main, Side, Repair, Replace..... WP 0043
- Stiffeners, Top/Bottom, Repair, Replace..... WP 0044

Main Risers, Repair, Replace..... WP 0036

Maintenance Allocation Chart (MAC)..... WP 0100

Maintenance Allocation Chart (MAC), Introduction..... WP 0099

Maintenance Checks and Services (PMCS):

- Field Preventive..... WP 0005

Maintenance Forms, Records, and Reports..... WP 0001

Main Parachute Packing Procedures..... WP 0014

Maintenance Procedures:

- Field..... WP 0006

Major Components:

- Description and Location of..... WP 0002
- Marking and Restenciling..... WP 0018

N

National Stock Number Index..... WP 0096

O

Official Nomenclature, Names, and Designations..... WP 0001

P

Packing Loop, Repair, Replace WP 0078

Packing Procedures:

 Main Parachute WP 0014

 Reserve Parachute WP 0015

Packing Tab, Repair, Replace WP 0079

Part Number Index WP 0097

PMCS Procedures WP 0005

PMCS Table WP 0005

Preparation for Shipment WP 0083

Preparation for Storage WP 0083

Preventive Maintenance Checks and Services (PMCS), Introduction WP 0004

R

Records, and Reports, Maintenance Forms WP 0001

References WP 0098

Repair Parts and Special Tools List (RPSTL):

 Group 00, Parachute System, Personnel, T-11 WP 0086

 Group 01, Main Canopy WP 0087

 Group 02, Main Risers WP 0088

 Group 03, Main Pack Tray WP 0089

 Group 04, Harness Assembly WP 0090

 Group 05, Reserve Canopy WP 0091

 Group 06, Reserve Parachute Riser WP 0092

 Group 07, Reserve Parachute Pack Tray Assembly WP 0093

 Group 08, Main Deployment Bag WP 0094

 Group 99, Bulk Material WP 0095

 Repair Parts and Special Tools List (RPSTL), Introduction WP 0085

Reserve Canopy:

 Apex Vent Bridle Loop, Repair, Replace WP 0062

 Connector Links, Replace WP 0059

 Ejector Spring Assembly, Test, Replace WP 0055

 Extractor Assembly, Replace WP 0054

 Gore Sections, Repair WP 0056

 Protection Cap, Replace WP 0060

 Reserve Canopy, Repair WP 0052

 Ripcord Assembly, Replace, Test WP 0072

 Scoop, Repair WP 0061

 Skirt Assist Ties, Replace WP 0058

 Suspension Line, Replace WP 0053

 Suspension Line Attaching Loop, Repair WP 0063

Reserve Pack Tray Assembly:

 Edge Binding, Repair WP 0067

 Elastic Riser Stow Bars, Repair, Replace WP 0069

 Fastener Tape Hook and Pile, Repair, Replace WP 0065

 Grommets Size #0, Repair, Replace WP 0068

 Pack Tray Assembly, Repair, Replace WP 0066

 Ripcord Assembly, Replace, Test WP 0072

 Stiffener, Replace WP 0071

 Waistband Retainer, Repair, Replace WP 0070

Reserve Parachute Packing Procedures WP 0015

Reserve Riser Assembly-Repair, Replace WP 0064

Reserve Riser Hook and Pile Fastener Tape-Repair, Replace WP 0065

S

Searing and Waxing WP 0017
Service Upon Receipt WP 0006
Shakeout and Airing WP 0009
Shipment, Preparation for WP 0083
Static Line Extension, Replace WP 0081
Static Line Snap Hook, Replace WP 0082
Storage, Preparation for WP 0083

T

Test WP 0013
Theory of Operation WP 0003
Tool Identification List WP 0102

U

Universal Static Line Modified (Modified), Replace WP 0080

These are the instructions for sending an electronic 2028

The following format must be used if submitting an electronic 2028. The subject line must be exactly the same and all fields must be included; however only the following fields are mandatory: 1, 3, 4, 5, 6, 7, 8, 9, 10, 13, 15, 16, 17, and 27.

From: "Whomever" <whomever@avma27.army.mil>

To: TACOMLCMC.DAForm2028@us.army.mil

Subject: DA Form 2028

1. From: Joe Smith
2. Unit: home
3. Address: 4300 Park
4. City: Hometown
5. St: MO
6. Zip: 77777
7. Date Sent: 19-OCT-93
8. Pub no: 55-2840-229-23
9. Pub Title: TM
10. Publication Date: 04-JUL-85
11. Change Number: 7
12. Submitter Rank: MSG
13. Submitter FName: Joe
14. Submitter MName: T
15. Submitter LName: Smith
16. Submitter Phone: 123-123-1234
17. Problem: 1
18. Page: 2
19. Paragraph: 3
20. Line: 4
21. NSN: 5
22. Reference: 6
23. Figure: 7
24. Table: 8
25. Item: 9
26. Total: 123
27. Text:

This is the text for the problem below line 27.

RECOMMENDED CHANGES TO PUBLICATIONS AND BLANK FORMS For use of this form, see AR 25-30; the proponent agency is ODISC4.						Use Part II (reverse) for Repair Parts and Special Tool Lists (RPSTL) and Supply Catalogs/Supply Manuals (SC/SM).	DATE 21 October 2003
TO: (Forward to proponent of publication or form) (Include ZIP Code) US ARMY TACOM LIFE CYCLE MANAGEMENT COMMAND ATTN: AMSTA-LCS-ECT 15 KANSAS ST NATICK, MA 01760-5052						FROM: (Activity and location) (Include ZIP Code) PFC JANE DOE Co A 3 RD Engineer Br. Ft Leonard Wood, MO 63108	
PART I - ALL PUBLICATIONS (EXCEPT RPSTL AND SC/SM) AND BLANK FORMS							
PUBLICATION/FORM NUMBER TM 10-1670-296-23&P						DATE 30 October 2002	TITLE Unit Manual for Ancillary Equipment for Low Velocity Air Drop Systems
ITEM NO.	PAGE NO.	PARA-GRAPH	LINE NO. *	FIGURE NO.	TABLE NO.	RECOMMENDED CHANGES AND REASON (Provide exact wording of recommended changes, if possible).	
	0036 00-2				1	<i>In Table 1, Sewing Machine Code Symbols, the second sewing machine code symbol should be MDZZ not MD22</i> <i>Change the manual to show Sewing Machine, Industrial: Zig-Zag; 308 stitch; medium-duty; NSN 3530-01-181-1421 as a MDZZ code symbol.</i>	
<i>*Reference to line numbers within the paragraph or subparagraph.</i>							
TYPED NAME, GRADE OR TITLE Jane Doe, PFC				TELEPHONE EXCHANGE/AUTOVON, PLUS EXTENSION (508) 233-4141 DSN 256-4141		SIGNATURE Jane Doe <i>Jane Doe</i>	

TO: <i>(Forward direct to addressee listed in publication)</i> US ARMY TACOM LIFE CYCLE MANAGEMENT COMMAND ATTN: AMSTA-LCS-ECT 15 KANSAS ST NATICK, MA 01760-5052	FROM: <i>(Activity and location) (Include ZIP Code)</i> PFC JANE DOE Co A 3 RD Engineer Br. Ft Leonard Wood, MO 63108	DATE 21 October 2003
---	--	--------------------------------

PART II – REPAIR PARTS AND SPECIAL TOOL LISTS AND SUPPLY CATALOGS/SUPPLY MANUALS

PUBLICATION NUMBER TM 10-1670-296-23&P	DATE 30 October 2002	TITLE Unit Manual for Ancillary Equipment for Low Velocity Air Drop Systems
--	--------------------------------	---

PAGE NO.	COLM NO.	LINE NO.	NATIONAL STOCK NUMBER	REFERENCE NO.	FIGURE NO.	ITEM NO.	TOTAL NO. OF MAJOR ITEMS SUPPORTED	RECOMMENDED ACTION
0066 00-					4			<i>Callout 16 in figure 4 is pointed to a <u>D-Ring</u>. In the Repair Part List key for Figure 4, item 16 is called a <u>Snap Hook</u>. Please correct one or the other.</i>

PART III – REMARKS *(Any general remarks or recommendations, or suggestions for improvement of publications and blank forms. Additional blank sheets may be used if more space is needed.)*

--

TYPED NAME, GRADE OR TITLE	TELEPHONE EXCHANGE/AUTOVON, PLUS EXTENSION	SIGNATURE
-----------------------------------	---	------------------

RECOMMENDED CHANGES TO PUBLICATIONS AND BLANK FORMS For use of this form, see AR 25-30; the proponent agency is ODISC4.	Use Part II (reverse) for Repair Parts and Special Tool Lists (RPSTL) and Supply Catalogs/Supply Manuals (SC/SM).	DATE
---	---	------

TO: (Forward to proponent of publication or form) (Include ZIP Code) US ARMY TACOM LIFE CYCLE MANAGEMENT COMMAND ATTN: AMSTA-LCL-MPP/TECHPUBS 1 Rock Island Arsenal ROCK ISLAND, IL 61299-7360	FROM: (Activity and location) (Include ZIP Code)
---	---

PART I – ALL PUBLICATIONS (EXCEPT RPSTL AND SC/SM) AND BLANK FORMS

PUBLICATION/FORM NUMBER TM 10-1670-326-23&P	DATE 16 March 2009	TITLE Field Maintenance Manual Including Repair Parts and Special Tools List for T-11 Personnel Parachute System
--	-----------------------	---

ITEM NO.	PAGE NO.	PARA-GRAPH	LINE NO. *	FIGURE NO.	TABLE NO.	RECOMMENDED CHANGES AND REASON <i>(Provide exact wording of recommended changes, if possible).</i>
----------	----------	------------	------------	------------	-----------	---

--	--	--	--	--	--	--

**Reference to line numbers within the paragraph or subparagraph.*

TYPED NAME, GRADE OR TITLE	TELEPHONE EXCHANGE/AUTOVON, PLUS EXTENSION	SIGNATURE
----------------------------	--	-----------

TO: <i>(Forward to proponent of publication or form) (Include ZIP Code)</i> US ARMY TACOM LIFE CYCLE MANAGEMENT COMMAND ATTN: AMSTA-LCL-MPP/TECHPUBS 1 Rock Island Arsenal ROCK ISLAND, IL 61299-7360	FROM: <i>(Activity and location) (Include ZIP Code)</i>	DATE
--	--	-------------

PART II – REPAIR PARTS AND SPECIAL TOOL LISTS AND SUPPLY CATALOGS/SUPPLY MANUALS

PUBLICATION NUMBER TM 10-1670-326-23&P	DATE 16 March 2009	TITLE Field Maintenance Manual Including Repair Parts and Special Tools List for T-11 Personnel Parachute System
---	-----------------------	--

PAGE NO.	COLM NO.	LINE NO.	NATIONAL STOCK NUMBER	REFERENCE NO.	FIGURE NO.	ITEM NO.	TOTAL NO. OF MAJOR ITEMS SUPPORTED	RECOMMENDED ACTION

PART III – REMARKS *(Any general remarks or recommendations, or suggestions for improvement of publications and blank forms. Additional blank sheets may be used if more space is needed.)*

Empty space for remarks

TYPED NAME, GRADE OR TITLE	TELEPHONE EXCHANGE/AUTOVON, PLUS EXTENSION	SIGNATURE
----------------------------	--	-----------

TO: (Forward to proponent of publication or form) (Include ZIP Code) US ARMY TACOM LIFE CYCLE MANAGEMENT COMMAND ATTN: AMSTA-LCL-MPP/TECHPUBS 1 Rock Island Arsenal ROCK ISLAND, IL 61299-7360	FROM: (Activity and location) (Include ZIP Code)	DATE
---	---	-------------

PART II – REPAIR PARTS AND SPECIAL TOOL LISTS AND SUPPLY CATALOGS/SUPPLY MANUALS

PUBLICATION NUMBER TM 10-1670-326-23&P	DATE 16 March 2009	TITLE Field Maintenance Manual Including Repair Parts and Special Tools List for T-11 Personnel Parachute System
---	-----------------------	--

PAGE NO.	COLM NO.	LINE NO.	NATIONAL STOCK NUMBER	REFERENCE NO.	FIGURE NO.	ITEM NO.	TOTAL NO. OF MAJOR ITEMS SUPPORTED	RECOMMENDED ACTION

PART III – REMARKS (Any general remarks or recommendations, or suggestions for improvement of publications and blank forms. Additional blank sheets may be used if more space is needed.)

Empty space for remarks

TYPED NAME, GRADE OR TITLE	TELEPHONE EXCHANGE/AUTOVON, PLUS EXTENSION	SIGNATURE
----------------------------	--	-----------

TO: (Forward to proponent of publication or form) (Include ZIP Code) US ARMY TACOM LIFE CYCLE MANAGEMENT COMMAND ATTN: AMSTA-LCL-MPP/TECHPUBS 1 Rock Island Arsenal ROCK ISLAND, IL 61299-7360	FROM: (Activity and location) (Include ZIP Code)	DATE
---	---	-------------

PART II – REPAIR PARTS AND SPECIAL TOOL LISTS AND SUPPLY CATALOGS/SUPPLY MANUALS

PUBLICATION NUMBER TM 10-1670-326-23&P	DATE 16 March 2009	TITLE Field Maintenance Manual Including Repair Parts and Special Tools List for T-11 Personnel Parachute System
--	------------------------------	--

PAGE NO.	COLM NO.	LINE NO.	NATIONAL STOCK NUMBER	REFERENCE NO.	FIGURE NO.	ITEM NO.	TOTAL NO. OF MAJOR ITEMS SUPPORTED	RECOMMENDED ACTION

PART III – REMARKS (Any general remarks or recommendations, or suggestions for improvement of publications and blank forms. Additional blank sheets may be used if more space is needed.)

--

TYPED NAME, GRADE OR TITLE	TELEPHONE EXCHANGE/AUTOVON, PLUS EXTENSION	SIGNATURE
----------------------------	--	-----------

By Order of the Secretary of the Army:

GEORGE W. CASEY, JR.
General, United States Army
Chief of Staff

Official:



JOYCE E. MORROW
Administrative Assistant to the
Secretary of the Army
0907704

DISTRIBUTION:

To be distributed in accordance with initial distribution number (IDN) 256991 requirements for TM 10-1670-326-23&P.

The Metric System and Equivalents

Linear Measure

1 centimeter = 10 millimeters = .39 inch
 1 decimeter = 10 centimeters = 3.94 inches
 1 meter = 10 decimeters = 39.37 inches
 1 dekameter = 10 meters = 32.8 feet
 1 hectometer = 10 dekameters = 328.08 feet
 1 kilometer = 10 hectometers = 3,280.8 feet

Weights

1 centigram = 10 milligrams = .15 grain
 1 decigram = 10 centigrams = 1.54 grains
 1 gram = 10 decigrams = .035 ounce
 1 dekagram = 10 grams = .35 ounce
 1 hectogram = 10 dekagrams = 3.52 ounces
 1 kilogram = 10 hectograms = 2.2 pounds
 1 quintal = 100 kilograms = 220.46 pounds
 1 metric ton = 10 quintals = 1.1 short tons

Liquid Measure

1 centiliter = 10 milliliters = .34 fl. ounce
 1 deciliter = 10 centiliters = 3.38 fl. ounces
 1 liter = 10 deciliters = 33.81 fl. ounces
 1 dekaliter = 10 liters = 2.64 gallons
 1 hectoliter = 10 dekaliters = 26.42 gallons
 1 kiloliter = 10 hectoliters = 264.18 gallons

Square Measure

1 sq. centimeter = 100 sq. millimeters = .155 sq. inch
 1 sq. decimeter = 100 sq. centimeters = 15.5 sq. inches
 1 sq. meter (centare) = 100 sq. decimeters = 10.76 sq. feet
 1 sq. dekameter (are) = 100 sq. meters = 1,076.4 sq. feet
 1 sq. hectometer (hectare) = 100 sq. dekameters = 2.47 acres
 1 sq. kilometer = 100 sq. hectometers = .386 sq. mile

Cubic Measure

1 cu. centimeter = 1000 cu. millimeters = .06 cu. inch
 1 cu. decimeter = 1000 cu. centimeters = 61.02 cu. inches
 1 cu. meter = 1000 cu. decimeters = 35.31 feet

Approximate Conversion Factors

<i>To change</i>	<i>To</i>	<i>Multiply by</i>	<i>To change</i>	<i>To</i>	<i>Multiply by</i>
inches	centimeters	2.540	ounce-inches	newton-meters	.007062
feet	meters	.305	centimeters	inches	.394
yards	meters	.914	meters	feet	3.280
miles	kilometers	1.609	meters	yards	1.094
square inches	square centimeters	6.451	kilometers	miles	.621
square feet	square meters	.093	square centimeters	square inches	.155
square yards	square meters	.836	square meters	square feet	10.764
square miles	square kilometers	2.590	square meters	square yards	1.196
acres	square hectometers	.405	square kilometers	square miles	.386
cubic feet	cubic meters	.028	square hectometers	acres	2.471
cubic yards	cubic meters	.765	cubic meters	cubic feet	35.315
fluid ounces	milliliters	29.573	cubic meters	cubic yards	1.308
pints	liters	.473	milliliters	fluid ounces	.034
quarts	liters	.946	liters	pints	2.113
gallons	liters	3.785	liters	quarts	1.057
ounces	grams	28.349	liters	gallons	.264
pounds	kilograms	.454	grams	ounces	.035
short tons	metric tons	.907	kilograms	pounds	2.205
pound-feet	newton-meters	1.356	metric tons	short tons	1.102
pound-inches	newton-meters	.11296			

Temperature (Exact)

°F Fahrenheit temperature $\frac{5}{9}$ (after subtracting 32) Celsius temperature °C

PIN: 085354-000